

Historic, Archive Document

Do not assume content reflects current scientific knowledge, policies, or practices.

62.37

SEASON OF 1922

LIBRARY
RECEIVED
JUN 14 1922
U.S. DEPARTMENT OF AGRICULTURE

WISEMAN-DOWNS CO. INC.

FARM MACHINERY AND
SEEDS

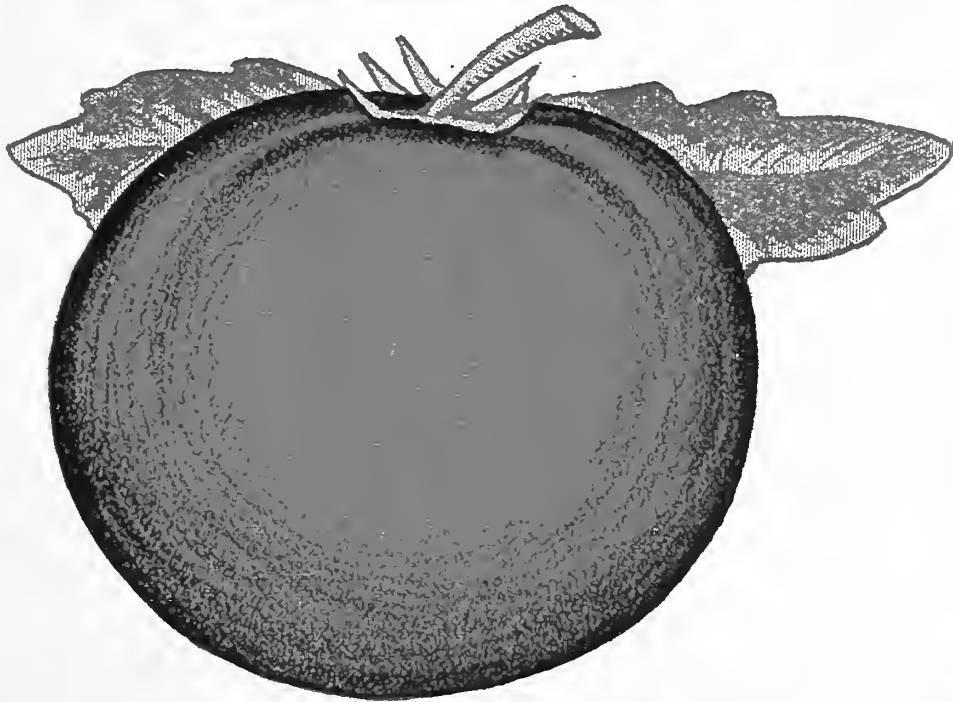

ORIGINATORS & GROWERS
OF THE
"WISDOM" TOMATO

34 EAST PRATT STREET
BALTIMORE, MD.

INDEX

	Page		Page
Asparagus Bunches.....	2	Mulford Culture.....	29
Asparagus Knives.....	2	Mole Traps.....	44
Back Bands.....	44	Mattocks and Handles.....	46
Brooms—Stable.....	44	Mowers—Lawn.....	61-62
Bone Cutters.....	44	Mowers—Field.....	79
Bone Mills.....	45	Nursery Stock.....	38 to 40
Baskets.....	48	Oils and Grease.....	94
Binders—Grain.....	82	Plow Lines.....	44
Binders—Corn.....	83	Plows—Walking.....	58
Cord.....	2	Plows—Sulky.....	59
Chains.....	44	Potato Diggers.....	60
Curry Combs.....	44	Pea and Bean Drills.....	65
Cultivators—Hand.....	50	Potato Cutter.....	67
Cultivators—Horse.....	52 to 54	Pump Jacks.....	70
Coulters.....	64	Plow Handles.....	70
Clippers—Horse.....	66	Powder Guns.....	70
Corn Shellers.....	67	Pumps.....	73-74
Cider Mills.....	69	Pole Saws.....	75
Corn Planters.....	84	Potato Planter.....	84
Cans—Garbage.....	93	Plants—Vegetable.....	8
Dairy Supplies.....	48-49	Potatoes—Seed.....	26
Double and Single Trees.....	63	Poultry Netting.....	46
Drills—Grain.....	72	Picks and Handles.....	46
Distributors—Fertilizer.....	85-85	Post Hole Diggers.....	46
Engines—Gasoline.....	75	Rakes—Hand.....	46
Ensilage Cutters.....	77 to 78	Row Markers.....	85
Forks—Manure.....	46	Rollers.....	86
Forks—Hay.....	46	Roofing, Cement and Paint.....	93
Forks—Spading.....	46	Spray Calender.....	41
Flower Guard.....	48	Scythes and Snaths.....	45
Farm Bells.....	65	Shears—Pruning.....	45
Feed Cookers.....	68	Shears—Hedge.....	45
Feed Grinders.....	91	Shovels.....	46
Grass Sickles.....	45	Seeds—Field.....	27 to 29
Grain Cradles.....	45	Seeds—Vegetable.....	2 to 25
Glazing Points.....	48	Seeds—Flower.....	30 to 35
Garden Syringe.....	48	Seeders—Hand.....	51
Herbs—Medicinal.....	21	Swings.....	62
Hose and Hose Reels.....	44	Shovel Plows.....	63
Hames and Straps.....	44	Seed Drills.....	65
Horse Radish Grater.....	44	Seed Sowers.....	69
Hoes.....	46	Sprayers—Traction.....	70
Hot-Bed Sash and Glass.....	48	Scales.....	70
Harrows—Spike.....	55	Spray Pumps.....	71 to 73
Harrows—Disc.....	56	Shredders and Huskers.....	83
Hay Tools.....	68	Saw Tables.....	89
Hay Rakes.....	80-81	Thermometers.....	44
Hay Tedders.....	80	Trowels.....	44
Hay Press.....	92	Tree Pruners and Knives.....	45
Insecticides.....	42-43	Troughs.....	66
Knives—Corn and Hay.....	45	Thresher.....	83
Kraut Cutters.....	46	Transplanters.....	88
Knife Grinders.....	65	Tractors.....	92
Lawn Grass Seed.....	28	Watering Pots.....	44
Lawn Sprinklers.....	44	Weeders—Hand.....	48
		Weeders—Horse.....	63
		Water Truck and Barrel.....	64
		Wheelbarrows.....	64
		Wire Fence.....	76
		Washing Machine.....	87
		Wagons.....	90

PLANTING, MATURITY AND WEIGHT TABLE

This is for field planting, and where plants and roots are stated, it is necessary to have them ready before-hand. The third column indicates the distance that the plants should stand in the rows, and where seed is sown they should be thinned out to this distance. The fifth column indicates maturity from the time plants are planted in the field or seed is sown in the field. Also note that the last column is the approximate weight of seeds and not products. Time of planting and maturity is for latitude of Baltimore, Md.

*Indicates that the crop can either be planted in the Spring or Fall; if in the Spring, February to April; in the Fall, August and September.

	Time to Sow or Plant	Distance of Rows Apart	Distance of Plants in Rows	Quantity per Acre	Ready to Use	Approximate Weight of Seeds per bu. in lbs.
Alfalfa	*May to Sept.	Broadcast	Broadcast	20 lbs.	Next Year	60
Art choke—Tubers	April to May	2½ ft.	2 ft.	6 to 8 bu.	Sept. to Oct.	50
Asparagus—Seeds	April to May	15 in.	4 to 6 in.	8 to 10 lbs.	3 years	60
Asparagus—Roots	March to April	6 to 8 ft.	12 to 18 in.	4,000 to 7,000	2 years
Beans—Dwarf	April to Aug.	2½ ft.	4 to 6 in.	90 lbs.	8 weeks	60
Beans—Navy	May to June	2½ ft.	6 in.	45 to 60 bu.	Winter	60
Beans—Soja	May to June	Broadcast	Broadcast	1 to 1½ bu.	Fall and Winter	60
Beans—Pole	May to June	4 ft.	3 ft.	40 lbs.	10 weeks	60
Beets—Table	March to July	12 to 13 in.	4 in.	6 to 8 lbs.	1½ to 3 mo.	19½
Beets—Sugar	April to June	2½ to 3 ft.	6 to 8 in.	5 to 6 lbs.	Fall and Winter	19½
Buckwheat	June to Aug.	Broadcast	Broadcast	1 bu. or 50 lbs.	Fall	50
Cabbage—Plants (early)	March to April	30 in.	15 to 20 in.	10,000 to 14,000	June and July	54
Cabbage—Plants (late)	July to Aug.	3 ft.	2 ft.	7,260	Fall and Winter	54
Carrot	April to June	1 to 2 ft.	3 to 4 in.	3 to 4 lbs.	45 to 70 days	28
Cauliflower—Plants	March to April	2½ ft.	2 ft.	8,000 to 10,000	3 months	54
Celery—Plants	June to Aug.	3 to 4 ft.	6 to 9 in.	15,000 to 30,000	4 to 5 months	37
Clover—Red and Sapling	*Feb. to Sept.	Broadcast	Broadcast	8 to 10 lbs.	Next Year	60
Clover—Alsike	*Feb. to Sept.	Broadcast	Broadcast	5 to 8 lbs.	Next Year	60
Clover—Crimson	July to Sept.	Broadcast	Broadcast	12 to 15 lbs.	May 1	60
Corn—Garden	April to July	3 to 3½ ft.	9 to 15 in.	8 lbs.	2 to 3 months	44 to 50
Corn—Field (drills)	April to July	3½ to 4 ft.	10 to 18 in.	7 to 8 lbs.	3 to 4 months	56
Corn—Field (checked)	April to July	3½ to 4 ft.	3½ to 4 ft.	6 lbs.	3 to 4 months	56
Cucumber	April to July	4 to 5 ft.	4 ft.	2 lbs.	2 to 2½ months	39
Egg Plant—Plants	May to June	3 ft.	2½ to 3 ft.	5,000 to 6,000	60 days	39
Endive	August	18 in.	12 in.	4 to 5 lbs.	2 to 2½ months	26
Grass Seeds—(Light)	*Feb. to Oct.	Broadcast	Broadcast	1½ to 2 bu.	Next Year	14
Grass Seeds—(Lawn)	*Feb. to Oct.	Broadcast	Broadcast	80 to 100 lbs.	8 to 10 weeks	20
Horseradish—Roots	Feb. to March	2½ ft.	12 to 18 in.	12,000 to 15,000	6 to 8 months
Kale—Spring	*Feb. to Sept.	Broadcast	Broadcast	6 to 8 lbs.	5 to 6 weeks	56
Kale—Winter	July to Sept.	Broadcast	Broadcast	3 to 4 lbs.	Fall to Spring	54
Kohl Rabi—Plants	April to May	1½ to 2 ft.	10 to 12 in.	21,000 to 34,000	2 1-3 to 3 months	56
Lettuce—Plants	April to Sept.	12 to 15 in.	6 to 8 in.	40,000 to 80,000	1½ to 2 months	35
Melon—Musk	May to July	4 to 6 ft.	4 to 6 ft.	2 lbs.	2½ to 3 months	32
Melon—Water	May to June	8 to 10 ft.	8 to 10 ft.	3 lbs.	3 months	35
Millet—German	May to July	Broadcast	Broadcast	1 bu.	6 to 7 weeks	50
Mustard	*March to Sept.	Broadcast	Broadcast	4 to 5 lbs.	6 to 8 weeks	56
Oats—Spring	March to April	Broadcast	Broadcast	1½ to 2 bu.	July 1	32
Oats—Winter	*Feb. to Sept.	Broadcast	Broadcast	1½ to 2 bu.	June 20 to July 10	32
Okra	April to May	2½ to 3 ft.	8 to 10 in.	8 to 10 lbs.	60 to 70 days	48
Onions—For large bulbs	April to May	12 to 14 in.	4 to 5 lbs.	Aug. to Sept.	39
Onions—For sets	April to May	10 to 12 in.	40 to 50 lbs.	Aug. to Sept.	39
Onion Sets	March to May	12 in.	4 in.	15 to 16 bu.	July	32
Parsley	March to April	12 in.	15 lbs.	July	42
Parsnips	March to April	18 in.	4 to 6 in.	5 to 7 lbs.	Fall and Winter	18
Peas—Smooth	Feb. to March	2½ to 3 ft.	84 to 112 lbs.	7 weeks	60
Peas—Wrinkled	April to May	2½ to 3 ft.	84 to 112 lbs.	7 to 9 weeks	56
Peas—Canada Field	Feb. to April	Broadcast	Broadcast	90 lbs.	June 15	60
Peas—Cow	May to July	Broadcast	Broadcast	1½ bu.	3 months	60
Pepper—Plants	May 15	30 in.	15 to 18 in.	11,000 to 14,000	2 to 2½ months	28
Potatoes—(Early)	March to April	27 in.	10 to 12 in.	8 to 12 bu.	June to July	60
Potatoes—(Late)	July to August	30 in.	15 to 18 in.	8 to 10 bu.	Oct. to Nov.	60
Sweet Potatoes—Plants	May 15	3 ft.	20 to 24 in.	7,000 to 8,000	Sept. to Winter	45
Pumpkin	May	8 to 10 ft.	8 to 10 ft.	2 lbs.	Fall	24
Radish	March to Aug.	10 to 15 in.	3 in.	8 to 10 lbs.	24 to 40 days	56
Rape	*Feb. to Sept.	Broadcast	Broadcast	6 to 8 lbs.	6 to 8 weeks	56
Rhubarb—Roots	March to April	4 ft.	2 to 3 ft.	5,000 to 7,000	Next Year
Rye	Aug. to Nov.	Broadcast	Broadcast	1 to 2 bu.	April 20	56
Salsify	March to April	1½ to 2 ft.	3 to 4 in.	6 to 8 lbs.	Fall and Winter	18
Spinach—Early	*Feb. to Sept.	Broadcast	Broadcast	15 to 20 lbs.	8 Weeks	48
Squash—Spring	May	4 ft.	3 ft.	3 lbs.	July	26
Squash—Winter	May to June	6 to 8 ft.	6 to 8 ft.	2 lbs.	Fall and Winter	22
Teosinte	May to June	3 to 3½ ft.	8 to 10 in.	3 to 5 lbs.	Aug. to Oct.	46
Tobacco—Plants	May to June	3 to 3½ ft.	2½ to 3 ft.	4,800 to 5,000	Sept. to Oct.	35
Tomato—Plants	May to July	4 ft.	3 to 4 ft.	2,700 to 3,600	July until frost	20
Turnip	March to Sept.	Broadcast	Broadcast	1½ to 2 lbs.	1½ to 2 months	56
Vetch	Aug. to Oct.	Broadcast	Broadcast	50 lbs.	May	50
Wheat	Sept. to Oct.	Broadcast	Broadcast	1 to 1½ bu.	July 1	60

HOME GARDENS WILL BE WORTH MORE THAN EVER BEFORE
INSURE YOUR GARDEN WITH WISEMAN-DOWNS SEEDS

BEST
BY
TEST

WISEMAN-DOWN CO., Inc.

BEST
BY
TEST

Farm and Garden Annual

ARTICHOKES

GREEN GLOBE—Plant vigorous and hardy, leaves silver gray, ribs reddish at the base and without spines; buds large, nearly round; scales pale green, shading to violet at the base. No other variety has such a broad, thick and fleshy receptacle or bottom. Height at stem about 2½ feet. **Pkt. 10c; oz. 50c.**

ARTICHOKE ROOTS

JERUSALEM—Sometimes called the American Artichoke. Used for table and stock feeding. Ready in April. **Pkt. 75c; bu. \$3.00.**

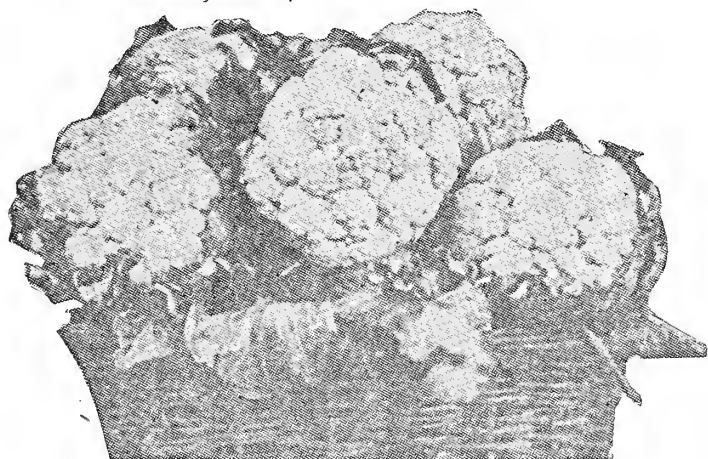

BROCCOLI

(German, Spargel Kohl)

The heads resemble somewhat a coarse cauliflower, and the culture is the same in all essentials as for that vegetable. Broccoli is well adapted only to those sections where the season is long, cool and rather moist. One of the most valuable features is that it withstands greater extremes of temperatures than cauliflower.

EARLY PURPLE CAPE—Pkt. 10c; oz. 60c.
LARGE EARLY WHITE—Pkt. 10c; oz. 60c.

BORECOLE, or KALE

Sometimes called broccoli by the market gardeners. This is one of the most delicious of all Winter Kales. Sown in May and transplanted to stand over Winter. **Pkts. 5c and 10c; oz. 20c; ¼ lb. 60c; lb. \$2.00.**

BRUSSELS SPROUTS

This vegetable is used in the Fall and early Winter and by some considered more tender and delicious than any cabbage. The plant resembles the cabbage, the edible part being the numerous very small heads or sprouts, an inch or two in diameter, formed on the stalk at each leaf joint. Culture is the same in all essentials as the cabbage, except the leaves should be broken down in the Fall to give the little heads more room to grow. **Pkts. 5c and 10c; oz. 20c; ¼ lb. 60c.**

ASPARAGUS ROOTS

We make a specialty of growing Asparagus Roots, taking care to have each variety true to name. Can supply any quantity in Spring and Fall.

	Per 100.	Per 1,000.
BARR'S MAMMOTH	\$1.00	\$6.50
PALMETTA	1.00	6.50
MAMMOTH WHITE	1.00	6.50
CONOVER'S COLOSSAL	1.00	6.50
GIANT ARGENTEUIL	1.00	6.50

ASPARAGUS



This can be grown from seeds or roots, the latter preferred. It is one of the earliest and most delicious of Spring vegetables. Seeds should be sown thinly in early Spring in rows 1 foot apart. Thin out the weakest plants so the remainder will be 4 inches apart. When 1 year old transplant in the permanent bed, from where it can be cut 3 years later. One ounce of seed will sow about 60 feet of drill. About 400 plants to the ounce. Asparagus may be grown in almost any soil or situation, but special success is attained in thoroughly enriched, deeply dug sandy loam. Beds cared for improve with age, lasting for many years.

PALMETTO ASPARAGUS—This is considered one of the best sorts. A large, dark green variety, of vigorous growth, having pointed tips. Very early and

prolific. **Pkt. 5c; oz. 10c; ¼ lb. 25c; lb. 75c.**

BONVALLET'S GIANT ASPARAGUS—In 1898, when nearly every plantation of Asparagus in the country was destroyed by rust, there was found by a Chicago gardener one perfectly healthy plant in a field of celebrated Giant Argenteuil variety. This plant was carefully saved, and was the progenitor of what is now called Bonvallet's Giant. As will be inferred, this sort is practically rust-proof. Besides this, it has no superior for color, size, rapid growth, etc. **Pkt. 5c; oz. 10c; ¼ lb. 25c; lb. 75c.**

MAMMOTH WHITE—A distinct variety, producing shoots which are white, and remain so as long as fit for use. Vigorous and robust in habit; grows large shoots. Needs no earthing up. **Pkt. 5c; oz. 10c; ¼ lb. 25c; lb. 75c.**

CONOVER'S COLOSSAL—Large and rapid grower, of excellent quality. **Pkt. 5c; oz. 10c; ¼ lb. 25c; lb. 75c.**

BARR'S MAMMOTH—A variety producing heavy, stout spears of delicious flavor; the growth remains green when cooked; a very popular sort. **Pkt. 5c; oz. 10c; ¼ lb. 25c; lb. 75c.**

GIANT ARGENTEUIL—A French white sort; very prolific; large white shoots. We consider it superior to Conover's Colossal. **Pkt. 5c; oz. 10c; ¼ lb. 25c; lb. 75c.**

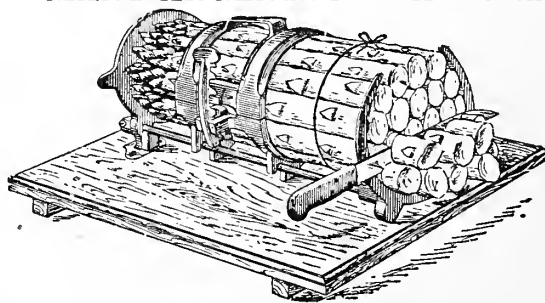

Asparagus Buncher, \$3.25.

Asparagus Knives, 50c.

PRICES ON CORD

3-Ply Fine Cotton Cord.....	40c lb.
2-Ply Coarse Cotton Cord.....	30c lb.
2-Ply Jute Twine.....	25c lb.
Raffia.....	20c lb.

Prices on larger quantities on application.

The "Wisdom" Stringless Bean

GROWN FOR QUALITY AND QUANTITY

Absolutely Stringless Tremendously Prolific

The plant is strictly dwarf, very erect while young, spreading when laden with fruit, 14 to 16 inches high, very vigorous and hardy, will withstand slight frost, branches green throughout, flowers light pink, pods large somewhat variable, 5½ to 6 inches long, dark green, making it exceedingly attractive, tremendously prolific and absolutely stringless. In this we have at last produced an absolutely round pod stringless bean. One that has become a favorite with the trucker, packer, shipper, market gardener and the kitchen gardener. We feel that in putting this bean on the market, we are putting money in the pockets of the trucker and market gardener, as it will readily command a higher price in the market than any other variety known. During the season of 1921 although, very dry, it stood the test and produced wonderful crops. It certainly has proved a money maker for those who planted it, in fact we cannot emphasize its good qualities too highly. **Pt. 30c; qt. 50c; pk. \$3.25; bu. \$12.00.**

GREEN POD BEANS--Dwarf

CULTURE—Sow in rows 2 feet apart, using about 1 quart to every 100 feet of drill. Keep the soil well stirred between the rows. Plant when all danger of frost is past, in succession, once every week until 8 weeks before frost.

BURPEE'S STRINGLESS GREEN POD is fast becoming one of the most popular beans in America. In earliness it is in the lead; in quality it is unexcelled, and as a cropper it is unrivaled. It is stringless in reality as well as in name. It is an abundant cropper, and the pods are full, round, fleshy and nearly straight. In length of pod it averages a little longer than Valentine; light green in color, and extremely handsome on the market bench. Quality is all that can be desired, so that for home use it is the just thing, and as it is a great cropper, market gardeners everywhere are finding it very profitable. We earnestly recommend it both for market and home use. It promises to almost displace the Valentine, rapidly becoming a favorite with the trucker and packer. **Pkts. 5c and 10c; pt. 25c; qt. 40c; pk. \$2.75; bu. \$10.00.**

DWARF HORTICULTURAL, or CHERRY—Vines very productive, compact, upright, with large leaves; pods medium length, cylindrical, curved, with splashes of bright red on a yellowish ground. **Pkts. 5c and 10c; pt. 25c; qt. 40c; pk. \$2.75; bu. \$10.00.**

BLACK VALENTINE—A splendid green string bean, with extra long, well-formed pods; tender, early and delicious; very prolific and profitable to grow. **Pkts. 5c and 10c; pt. 20c; qt. 35c; pk. \$2.25; bu. \$8.00.**

BOUNTIFUL—This new green-podded bush bean is a heavy cropper and very early, of fine shape, stringless and good quality. Its hardiness and great productiveness make it one of the very best bush beans. **Pkts. 5c and 10c; pt. 25c; qt. 40c; pk. \$2.75; bu. \$10.00.**

NAVY, or PEA BEAN—The standard shell bean; very prolific. **Pt. 15c; qt. 25c; pk. \$1.75; bu. \$6.00.**

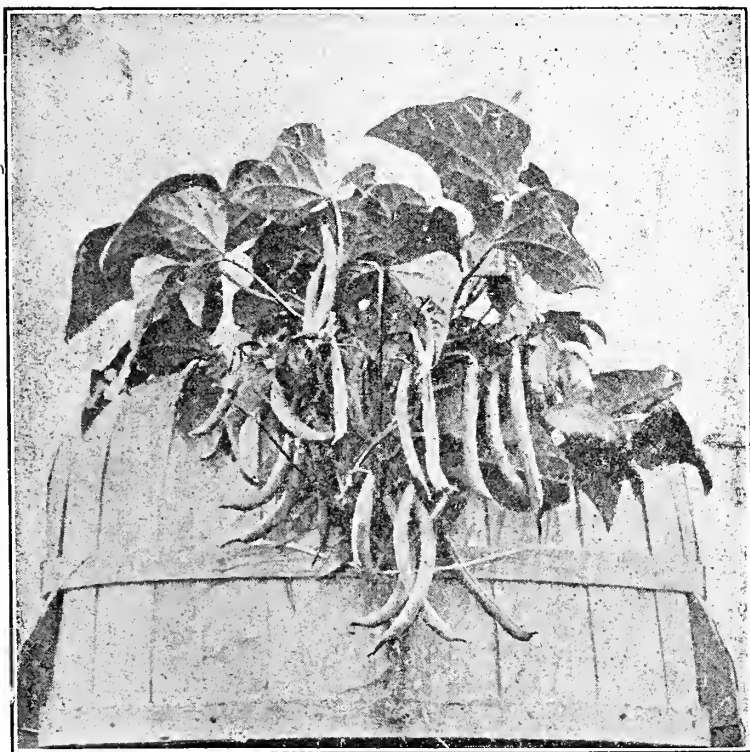

Burpee's Stringless Green Pod



The "Wisdom" Stringless

LONG YELLOW SIX WEEKS—The vine is large, vigorous, branching and productive, with large leaves. Pods long, straight, thick, flat in shape, green in color, of good quality when young and fair as they near maturity. Is ready for picking 45 days from planting. **Pkts. 5c and 10c; pt. 25c; qt. 40c; pk. \$2.75; bu. \$10.00.**

GIANT STRINGLESS GREEN POD—An exceedingly productive and very handsome sort. Vines vigorous and spreading. The pods mature a few days later than those of Stringless Green Pod, average about ¼ incher longer and more nearly straight. The quality is very good for home use; suitable also for the market. **Pkts. 5c and 10c; pt. 25c; qt. 40c; pk. \$2.75; bu. \$10.00.**

BEST OF ALL—This is an exceptionally good variety for home or market garden. Pods are about 6 inches long, fleshy and of good quality. Stringless, early and prolific. **Pkt. 5c and 10c; pt. 25c; qt. 40c; pk. \$2.75; bu. \$10.00.**

MAY QUEEN—Each season this sort is becoming more extensively planted by growers for the earliest market. Will stand more frost than any other bean, is earlier than the Valentine, enormously productive; makes round, straight, tender pods of an attractive appearance. **Pkts. 5c and 10c; pt. 20c; qt. 35c; pk. \$2.25; bu. \$8.00.**

WISEMAN-DOWNS CO.'S NEW PROLIFIC—A new prolific long-podded variety. Pods brittle and entirely stringless, produced on heavy vines throughout a long season. For all purposes. **Pkts. 5c and 10c; pt. 25c; qt. 40c; pk. \$2.75; bu. \$10.00.**

EXTRA-EARLY RED VALENTINE—A very early variety of good quality, maturing in 45 to 50 days. **Pt. 20c; qt. 35c; pk. \$2.25; bu. \$8.00.**

Our Seed Beans are grown especially for seed purposes, and are carefully selected for purity and yielding qualities. The growing crops are carefully rogued each season, and are consequently free from disease or other faults often found in seed offered at a low price. Seed that is not bred for yielding qualities is productive of a heavy loss by reason of the vines throwing few pods and few beans in the pod.

LONGFELLOW—Extra early, very prolific; tender, delicious quality. The Longfellow is an ideal snap bean, a prolific producer of perfectly round, straight, solid, fleshy pods, averaging 6½ inches long; exceedingly tender and brittle. Plants are of robust, compact habit; a very heavy cropper. **Pkt. 5c and 10c; pt. 20c; qt. 35c; pk. \$2.25; bu. \$8.00.**

WHITE MARROWFAT—Mostly planted for Winter use as a dry bean. **Pkts. 5c and 10c; pt. 20c; qt. 35c; pk. \$2.25; bu. \$8.00.**

BEANS — Wax-Podded

DAVIS WAX—The most productive wax bean in cultivation. The vine is rustless and very vigorous, bearing its pods near the center in clusters. The pods are invariably long, white, straight and handsome, and when young are brittle, crisp and tender. Seed kidney-shape, clear white and excellent for baking. One of the best for shipping as snap beans and of the greatest value as a market variety. The length, uniformly perfect shape and fine color of the pods and the clear white seed make this one of the best for canners. **Pkts. 5c and 10c; pt. 25c; qt. 40c; pk. \$2.75; bu. \$10.00.**

CURRIE'S RUSTPROOF BLACK WAX—The earliest. Habit upright and robust, holding their pods well from the ground. Foliage remarkably vigorous and healthy. Pods long, flat and straight; beautiful golden color; unequaled for productiveness. **Pkts. 5c and 10c; pt. 25c; qt. 40c; pk. \$2.75; bu. \$10.00.**

PROLIFIC GERMAN BLACK WAX—A well-known popular variety. The most striking feature of this variety is its habit of ripening a large proportion of the crop earlier than other varieties. This fact is of great value to market gardeners and all who depend on being first on the market. Dwarf bush growth and very



Burpee's Improved Bush Lima

prolific. This is one of the earliest. Pods 4 to 5 inches in length, usually curved, quite round; meaty, brittle and stringless; deep golden yellow, of excellent flavor. **Pkts. 5c and 10c; pt. 25c; qt. 40c; pk. \$2.75; bu. \$10.00.**

WARDWELL'S KIDNEY WAX—Strong, upright bush; growth 15 inches in height; very productive; pods straight, fleshy, 5 inches in length and ½ inch broad. A rich golden yellow; brittle and quite stringless even when fully developed; of rich, luscious flavor, and are exceedingly brittle. A great favorite with market gardeners. **Pkts. 5c and 10c; pt. 25c; qt. 40c; pk. \$2.75; bu. \$10.00.**

PENCIL-POD WAX—Extremely early and very prolific. Plants are upright in growth and make a strong, vigorous bush about 15 inches high. Beautiful golden yellow and perfectly rounded pods. Absolutely stringless and an excellent flavor. **Pkts. 5c and 10c; pt. 25c; qt. 40c; pk. \$2.75; bu. \$10.00.**

RUST-PROOF GOLDEN WAX—Very vigorous in growth and extremely early. One of the hardiest of all wax sorts. Pods are straight, long and much thicker than the ordinary Golden Wax. A favorite with the home gardener. **Pkts. 5c and 10c; pt. 25c; qt. 40c; pk. \$2.75; bu. \$10.00.**

NEW HODSON WAX—A vigorous grower, and the yield of large, handsome pods is enormous. Their color is a clear creamy white; very long, straight or slightly curved, flat but fleshy. While late in maturing, the remarkable vigor of the plant is an effectual safeguard against blight and other bean disease. Seed light; yellowish brown, splashed with dull crimson. **Pkts. 5c and 10c; pt. 25c; qt. 40c; pk. \$2.75; bu. \$10.00.**

BEANS — Bush Lima

CULTURE—Soil should be of a rich loam. Plant in rows 2 feet apart and 6 inches in the row. Plant after all danger of frost has passed. A top dressing of well-rotted stable manure or some good fertilizer will help wonderfully.

BURPEE'S BUSH LIMA—Bushes grow 18 to 20 inches high, stout growth and always erect, yet branching so vigorously that each plant develops into a magnificent circular bush 2 to 3 feet in diameter; an immense yielder, each bush bearing 150 to 200 handsome large pods, well filled. **Pkts. 5c and 10c; pt. 25c; qt. 40c; pk. \$3.00; bu. \$11.00.**

DREER'S BUSH LIMA—Dwarf variety of Dreer's Improved Lima, which has been fixed in its character of a bush bean; very prolific, single plants often producing 50 to 200 pods. Equal in quality and tenderness to Dreer's Pole Lima. **Pkts. 5c and 10c; pt. 25c; qt. 40c; pk. \$3.00; bu. \$11.00.**

THE "BURPEE IMPROVED" BUSH LIMA—Will outyield Burpee's Bush Lima by fully one-third. This greater yield is due to the increased size of both pod and beans. The dried beans are very handsome and generally show a greenish-white coloring, while dried beans, of the Burpee Bush Lima, like those of the large Pole Lima, are pure white. **Pkts. 5c and 10c; lb. 40c; pt. 25c; qt. 40c; pk. \$3.00; bu. \$11.00.**

FORDHOOK BUSH LIMA—An improved dwarf lima of the Kumerle type. The plant is vigorous and erect growing, bearing well above the ground. The pods are produced in large clusters, each containing 3 to 5 large beans of exceptionally fine quality. Much more productive than Kumerle and matures earlier. We consider this a decided acquisition to the dwarf Lima, possibly the best of the class. **Pkts. 5c and 10c; pt. 25c; qt. 40c; pk. \$3.00; bu. \$11.00.**

HENDERSON'S DWARF LIMA—These are very valuable because they do not need poles, and being so dwarf, can be planted close together. They are very early and prolific, continuing to bear until frost. **Pkts. 5c and 10c; pt. 25c; qt. 40c; pk. \$3.00.**

BEANS — Pole Lima

CULTURE—Plant when all danger of frost or cold nights are over. Don't be afraid to put a liberal number in a hill, as this is cheaper than replanting. Set poles 4 feet apart each way. Thin out to 3 plants to a pole. One quart will plant 100 hills; 12 to 15 quarts per acre.

CARPENTERIA—This new bean, of recent introduction, is rapidly coming to the front as a favorite with market gardeners and truckers generally. While it has all the good qualities of the King of the Garden, it is even better, as the beans have a better appearance. Color is a bright green. It is early, yet keeps bearing until frost. Pods are filled with 4 to 5 large mealy beans, of the very finest flavor. Vines are vigorous and strong in growth, producing a number of pods, well filled. **Pkts. 5c and 10c; pt. 25c; qt. 40c; pk. \$2.75; bu. \$11.00.**

LARGE WHITE LIMA—Vine tall, vigorous, but slender; leaves medium-sized, smooth, light green. Pods borne in clusters 5 to 5½ inches long, broad, very thin, dark green. Seed very large, ovoid, flat, greenish-white. **Pkts. 5c and 10c; pt. 25c; qt. 40c; pk. \$2.50; bu. \$9.00.**

KING OF THE GARDEN LIMA—Vines very vigorous and productive. Pods 5 to 6 inches long, filled with 4 or 5 immense white beans of the finest quality. On account of its large pods, it is a favorite with market gardeners. It will come into bearing sooner and will make larger pods if not more than 2 vines are left to grow on a pole. Seed very large, ovoid, flat, with slight greenish tinge. **Pkts. 5c and 10c; pt. 25c; qt. 40c; pk. \$2.75; bu. \$10.00.**

DREER'S IMPROVED, or CHALLENGE—Vines stout, vigorous and productive. Pods about 4 inches long, shorter and comparatively thicker than those of the other pole limas, and contains 4 to 5 beans, which are large, thick, white and of the best quality. **Pkts. 5c and 10c; pt. 25c; qt. 40c; pk. \$3.00; bu. \$11.00.**

SEIBERT'S EARLY LIMA—The vine is vigorous, very productive and continues so from the very first to the last of the season; so that, although the pods rarely contain more than 4 beans, the total yield is enormous. Pods about 5 inches long. The green shelled beans are very large, very tender and of finest quality. **Pkts. 5c and 10c; pt. 25c; qt. 40c; pk. \$2.75; bu. \$10.00.**

HENDERSON'S EARLY LEVIATHAN—This is the earliest. It will produce very large beans earlier than any other variety. It is very productive, both early and throughout the season. **Pkts. 5c and 10c; pt. 25c; qt. 40c; pk. \$2.75; bu. \$10.00.**

FORD'S MAMMOTH—The pods grow to an average length of 8 inches, are produced in great clusters, with from 5 to 7 beans per pod, of most excellent quality,

for using either green or dry. The vines grow vigorously, setting the beans early at the bottom of the pole, and continue in bearing up to frost. **Pkts. 5c and 10c; pt. 25c; qt. 40c; pk. \$2.50; bu. \$9.00.**

EXTRA-EARLY JERSEY—This is an extremely early variety, ripening 2 weeks earlier than any other sort. Pods are thin and very easily opened. The vine is very productive and exceptionally hardy and vigorous. The quality of the bean, its size and beauty make it one of the best. **Pkts. 5c and 10c; pt. 25c; qt. 40c; pk. \$2.45; bu. \$10.00.**

BEANS—Pole

LAZY WHITE POLE BEANS—As this can be used as a shell or green bean, makes it very valuable for every home gardener as well as the market gardener. Pods are large and mealy; ripens early and very prolific. **Pkts. 5c and 10c; pt. 25c; qt. 40c; pk. \$2.75; bu. \$10.00.**

KENTUCKY WONDER—Vine vigorous, climbing well and very productive; dry beans, long, oval, dun-colored; green pod, 9 and 10 inches long. **Pkts. 5c and 10c; pt. 25c; qt. 40c; pk. \$2.75; bu. \$10.00.**

HORTICULTURAL, or SPECKLED CRANBERRY—Beans large, ovate, splashed and spotted with wine red, and of the highest quality; either green or dry. **Pkts. 5c and 10c; pt. 25c; qt. 40c; pk. \$2.75; bu. \$10.00.**

RED SPECKLED CUT SHORT (CORN HILL)—This is the best sort to plant in hills of corn. **Pkts. 5c and 10c; pt. 25c; qt. 40c.**

DUTCH CASE KNIFE—Vines moderately vigorous, climbing well, but twining more loosely than some, and so may be used for a corn hill bean. **Pkts. 5c and 10c; pt. 25c; qt. 40c.**

BEETS

CULTURE—The soil best suited for Beet culture is that which is rather light and well enriched. Sow in drills 1 foot apart and 1 inch deep, as early as the ground can be worked. When the plants are large enough thin out to 4 inches apart in rows. One ounce of seed will sow 100 feet of drill.



LEXINGTON MARKET BEAUTY—(See cut.)—The best of the larger sorts. It succeeds equally well at all seasons; the tops make an upright growth, thus allowing of planting in close rows, which is a valuable feature where space in the garden is limited. The quality is excellent, tender, sweet and quite free from tough fibre. The color is most attractive, being a deep blood red. The root is somewhat globe shape. For the trucker or market gardener it cannot be beaten. It is also the best for canning on account of its excellent flavor. **Pkts. 5c; oz. 10c; ¼ lb. 35c; lb. \$1.00.**

DETROIT DARK RED—The uniformity of size, shape and fine appearance puts this variety at once among the leaders of this most desirable of all vegetables. Tops small and upright, admitting of close planting. Roots medium in size, globular or oval and very smooth; skin a dark blood red; flesh deep bright red, zoned with a lighter shade, fine-grained, crisp, tender and sweet, remaining so long after many sorts become woody. This is certainly a market gardener's beet. **Pkt. 5c; oz. 10c; ¼ lb. 25c; lb. 75c.**

EARLY MARKET—Its qualities are extra early, dark red color, fineness of shape and small top. One of the most attractive varieties grown, and is especially desirable for hotbeds on account of its small top and close-growing habit. **Pkts. 5c and 10c; oz. 15c; ¼ lb. 30c; lb. 90c.**

SWISS CHARD, or SPINACH BEET—This variety does not produce an edible root, but its top growth, which is silver-leaved, can be separated, the rib and the leaf; while the former is cooked and served like asparagus, the latter is prepared like spinach, and has altogether a **decidedly splendid flavor.** **Pkts. 5c; oz. 10c; ¼ lb. 25c; lb. 75c.**

"The beet seed purchased of you last year yielded the best and prettiest crop I have ever had and commanded the highest prices."—RICHARD C. OLER, Arlington, Md.

ECLIPSE—A very early globe-shaped table beet. It has small tops and is smooth, fine-grained and tender, with bright red color. Many market gardeners have discarded Egyptian entirely in favor of the Eclipse. **Pkt. 5c; oz. 10c; ¼ lb. 25c; lb. 75c.**

CROSBY'S EGYPTIAN—A carefully selected strain of Egyptian, as early as the original, but larger, thicker, smoother and of better quality. Flesh deep blood red. It is a rapid grower, attaining a usable size quicker than any other variety, and does not become woody with age. **Pkt. 5c; oz. 10c; ¼ lb. 25c; lb. 75c.**

EXTRA-EARLY BLOOD TURNIP—Fine for forcing and for first early crop out of doors. Toots rich, dark crimson with very small tap roots; flesh dark blood red, zoned with lighter shade; crisp, sweet and tender when young. **Pkt. 5c; oz. 10c; ¼ lb. 25c; lb. 75c.**

EXTRA-EARLY EGYPTIAN—This is a flat beet, very early and deep red color. Owing to the small top, it can be planted very early. **Pkt. 5c; oz. 10c; ¼ lb. 25c; lb. 75c.**

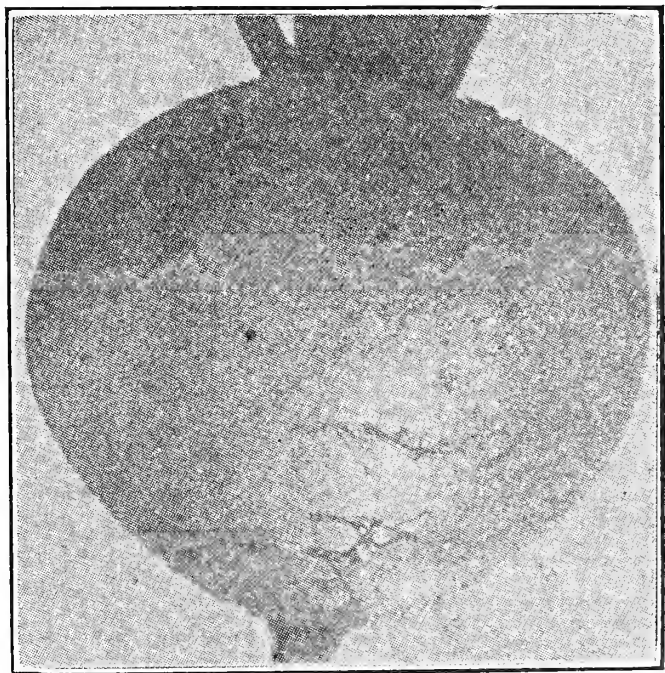

Detroit Dark Red Beet

CATTLE BEETS

(German, Mangel Wurzel)

CULTURE—Sow 5 pounds per acre in April and May in thoroughly plowed, well-manured soil, in drills 2 inches deep, about 24 inches apart. Thin out to 12 inches and keep the weeds down by frequent hoeing and cultivating. Low ground is best adapted for Mangel Wurzel.

MAMMOTH LONG RED—This is an enormously productive variety, yielding from 50 to 70 tons to the acre, a single root often weighing from 20 to 40 pounds. It is the best long red Mangel. **Pkt. 5c; ¼ lb. 15c; lb. 50c.**

GOLDEN TANKARD—The best long yellow Mangel in cultivation. Relished by milch cows and sheep. Maturing earlier than other larger sorts. **Pkt. 5c; ¼ lb. 15c; lb. 50c.**

WHITE SUGAR—This variety attains an enormous size, growing considerably above the ground; one of the best for stock feeding. **Pkt. 5c; ¼ lb. 15c; lb. 50c.**

CHAMPION YELLOW INTERMEDIATE, or GATE-POST MANGOLD—One of the very finest Mangolds ever introduced, giving unbounded satisfaction wherever grown. With good cultivation will crop at the rate of 200 bushels per acre. **Pkt. 5c; ¼ lb. 15c; lb. 50c.**

CABBAGE

(German, Kohl; French, Chou; Spanish, Berza)

The requisites for complete success with Cabbage are: First, good seed. (In this crop the quality of the seed used is of the greatest importance; no satisfactory results can possibly be obtained when poor seed is planted.) Second, rich, well-prepared ground. (A heavy, moist and rich loam is most suitable.) Third, frequent and thorough cultivation. The ground should be highly manured and worked deep. Our Cabbage Seeds are American-grown, and we are certain that better seed could not be obtained, as they are grown from specially selected seed stock, and are not simply strains of other varieties, but true and distinct varieties. One ounce of seed to 100 yards of row.

DANISH BALL HEAD—A good main-crop variety; popular with many of the gardeners. Large, solid, round head; medium early, having few outer leaves, consequently can be planted very close together. **Pkts. 5c and 10c; oz. 20c; ¼ lb. 60c; lb. \$2.00.**

CHARLESTON, or Large Wakefield—A strain in which the plant is larger and a little later than Early Jersey Wakefield, the head being fully as solid, but less pointed and considerably larger. Leaves rather large, smooth and comparatively thick. Exceedingly hardy, and on account of its earliness and size of head, with market gardeners and shippers it is deservedly a very popular sort to follow Jersey Wakefield. The seed we offer can be depended on to produce uniformly fine, marketable heads. **Pkts. 5c and 10c; oz. 20c; ¼ lb. 60c; lb. \$2.00.**

FOTTELER'S EARLY DRUMHEAD, or SHORT-STEM BRUNSWICK—The plants are of dwarf, compact growth; solid, flat heads. The foliage is a light bluish-green. Much earlier than the Flat Dutch varieties. **Pkts. 5c and 10c; oz. 20c; ¼ lb. 60c; lb. \$2.00.**

SUCCESSION—Very popular with the market gardener, producing enormous, uniform heads, and matures a few days later than Early Summer. **Pkts. 5c and 10c; oz. 20c; ¼ lb. 60c; lb. \$2.00.**

EARLY DRUMHEAD—Very large, flat head, with few outer leaves. It follows in maturing the Large Charleston Wakefield. **Pkts. 5c and 10c; oz. 20c; ¼ lb. 60c; lb. \$2.00.**

EARLY FLAT DUTCH—Very compact grower, with a medium-size, roundish, flat head, which is always solid. **Pkts. 5c and 10c; oz. 20c; ¼ lb. 60c. lb. \$2.00.**

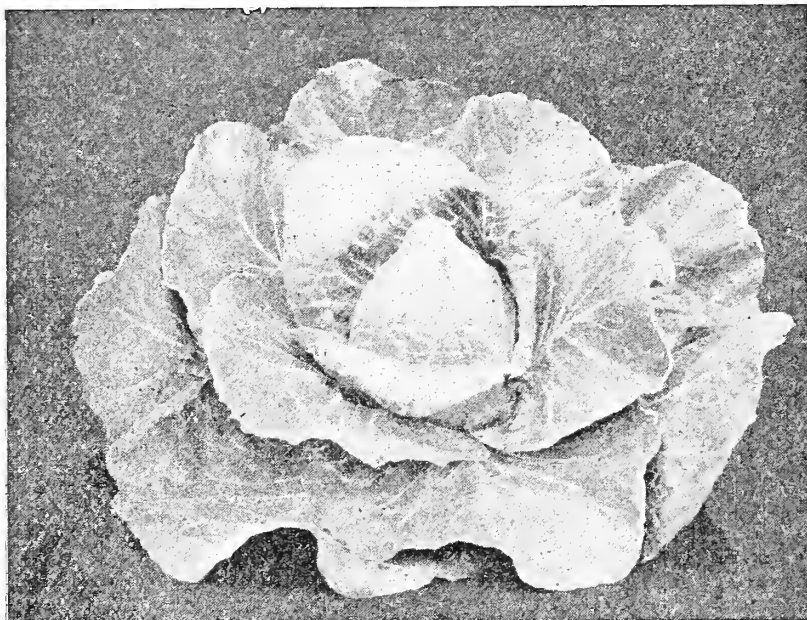

Early Jersey Wakefield

EARLY JERSEY WAKEFIELD—The earliest and surest heading of first early Cabbage. Most gardeners depend upon it for the bulk of their extra-early crop. Its exceeding hardiness, not only to resist cold, but other unfavorable conditions, insures the greatest likelihood of profitable and satisfactory results. Our stock is grown and selected with the greatest care; there is none better and there are few as good. Plant compact, with few outer leaves, which are smooth and thick. Heads of medium size, solid, uniformly pointed and of excellent quality. The habit of growth and hardiness make it most desirable for early planting. **Pkts. 5c and 10c; oz. 20c; ¼ lb. 60c; lb. \$2.00.**

LARGE EARLY YORK—One of the earliest; heads medium size, pointed. **Pkts. 5c and 10c; oz. 20c; ¼ lb. 60c; lb. \$2.00.**

PREMIUM FLAT DUTCH—This variety of late Cabbage is a standard in all sections for Winter use. It makes a large, solid head, which keeps long without bursting, and is adapted to a more varied climate than probably any other variety. **Pkts. 5c and 10c; oz. 20c; ¼ lb. 60c; lb. \$2.00.**

EARLY WINNINGSTADT—An old and very popular variety. Heads cone-shaped; very early. **Pkts. 5c and 10c; oz. 20c; ¼ lb. 60c; lb. \$2.00.**

HENDERSON'S EARLY SUMMER—Enormous solid heads, roundish flat; one of the best midsummer varieties, and is a ready seller. **Pkts. 5c and 10c; oz. 20c; ¼ lb. 60c; lb. \$2.00.**

SUREHEAD—This is rightly named Surehead, as it never fails to make a fine large head which is solid and uniform, with few outer leaves. A sure header and a sure cropper. **Pkts. 5c and 10c; oz. 20c; ¼ lb. 60c; lb. \$2.00.**

ALL SEASONS—American grown. This forms a fine large head, of superior quality, nearly as early as the Early Summer. Suitable for planting at any season. **Pkts. 5c and 10c; oz. 20c; ¼ lb. 60c; lb. \$2.00.**

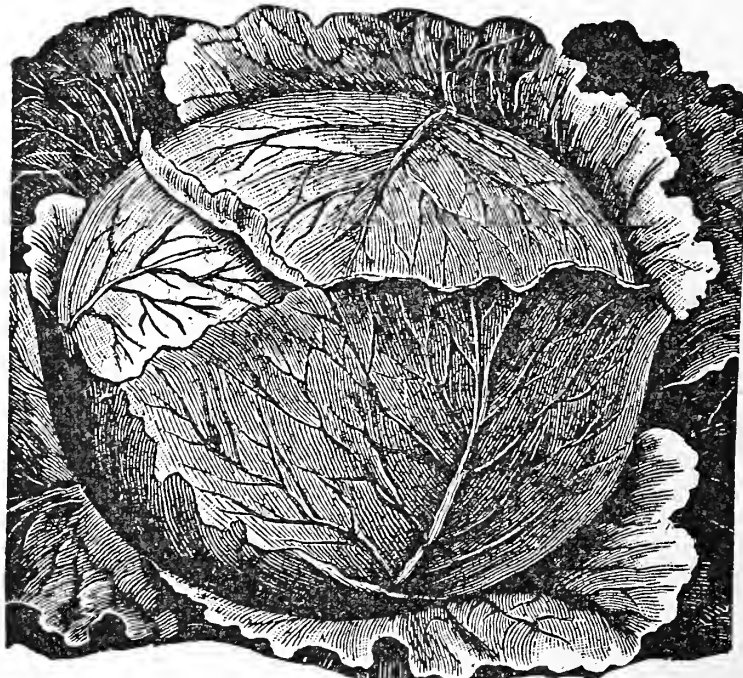

Premium Flat Dutch

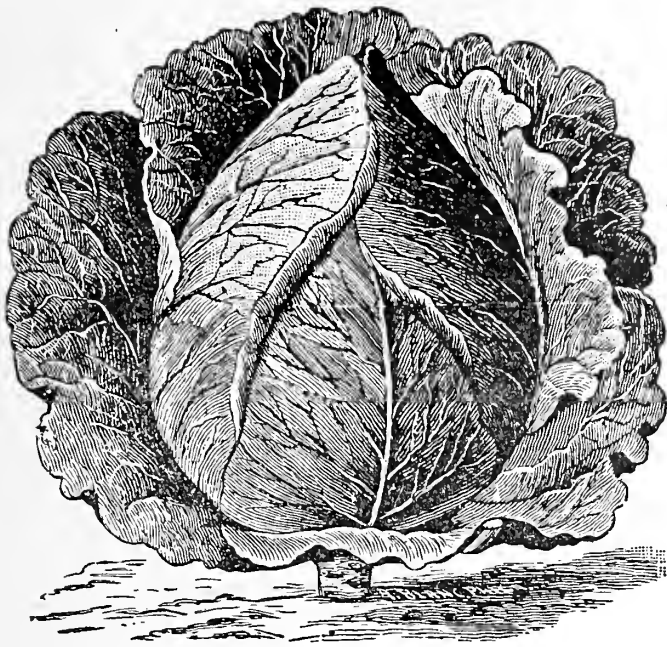

Charleston, or Large Wakefield Cabbage

WORLD BEATER, or AUTUMN KING—This is a very superior late Cabbage. The large, broad heads are very thick through, slightly rounded at the top, fine-

grained and tender; has a short stalk, green color, and one of the best keepers we know, and is a rapid grower. **Pkts. 5c and 10c; oz. 20c; ¼ lb. 50c; lb. \$2.00.**

LARGE LATE AMERICAN DRUMHEAD—Especially desirable for Fall and Winter use. It is extremely uniform in heading and dwarf in growth, so that the largest number can be raised on a given area. Has few outer leaves; extra-hard head. **Pkts. 5c and 10c; oz. 20c; ¼ lb. 50c; lb. \$2.00.**

PERFECTION DRUMHEAD SAVOY—This is the hardest heading and best all-round Savoy. Heads beautifully blanched and of the finest flavor. **Pkts. 5c and 10c; oz. 20c; ¼ lb. 50c; lb. \$2.00.**

ALL HEAD—The largest of the early Cabbages, being roundish flat and very solid. **Pkts. 5c and 10c; oz. 20c; ¼ lb. 50c; lb. \$2.00.**

RED ROCK—While late in maturing, this is the largest heading of all deep red varieties. **Pkts. 5c and 10c; oz. 25c; ¼ lb. 75c; lb. \$3.25.**

GEORGIA COLLARDS—Called the Cabbage Collard on account of its close bunching growth. The plant produces center leaves generally perfectly white, though sometimes dashed with pink. It is a very delicate vegetable and of the finest quality. **Pkts. 5c and 10c; oz. 15c; ¼ lb. 50c; lb. \$1.50.**

NEW EARLY—Our strain of this variety is of special value because of its close adherence to the types in habit of growth and the shape and quality of the head. Plant compact, with few outer leaves, which are smooth and rather thick. Head very large for so early a variety, very solid, flat, but very deep and uniform in size and shape. Quality excellent. **Pkts. 5c and 10c; oz. 20c; ¼ lb. 50c; lb. \$2.00.**

CARROT

CULTURE—While a sandy loam, made rich by manuring the previous year, is the best soil for the Carrot, any good land, if thoroughly and deeply worked, will produce satisfactory crops. It is advisable to sow as early in the Spring as the ground is fit to work, though good crops may be grown from sowings as late as June 15. For table use, sow the smaller kinds early in rows 16 to 18 inches apart. For field culture, sow the drills 18 to 24 inches apart, using from 1½ to 3 pounds of seed to the acre. Cover ½ to 1 inch deep. One ounce of seed to 100 feet of row.

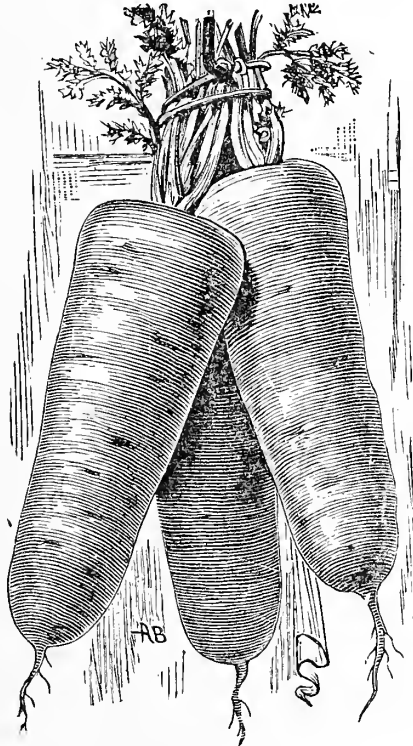

Improved Long Orange

DANVERS—A half-long orange carrot, grown largely on account of its great productiveness and adaptability to all classes of soil. Tops of medium size. Roots of medium length, 6 to 8 inches long, tapering uniformly to a blunt point. Flesh deep orange, crisp and tender. Although the roots of this variety are comparatively short, they produce as large a bulk as the longer field sorts and are more easily harvested. **Pkts. 5c and 10c; oz. 10c; ¼ lb. 25c; lb. 75c.**

CHANTENAY, or PRIDE OF THE MARKET—Very productive, medium early and of excellent quality. Tops medium-sized; necks small. Roots thick, 5¼ to 6 inches in length, uniformly half-long or stump-rooted, but tapering slightly; smooth, deep orange color. Flesh

very crisp and tender. Although a medium-early sort, the roots are suitable for use nearly as early as any. One of the best in quality for the market and home garden, while its great productiveness and the ease with which it can be harvested make it very desirable as a field sort. **Pkts. 5c and 10c; oz. 10c; ¼ lb. 25c; lb. 75c.**

EARLY SCARLET HORN—Excellent for early planting out of doors. Tops small. Roots orange-red, about 3 inches long, top-shaped, but tapering abruptly to a small tap. **Pkts. 5c and 10c; oz. 10c; ¼ lb. 25c; lb. 75c.**

IMPROVED LONG ORANGE—The roots of the strain we offer are very deep orange, long and comparatively thick, often 12 inches in length and 3 inches in diameter at the crown, tapering regularly to a point. Tops small for the size of the root. Suitable for table use as well as stock feeding, combining great productiveness with uniform shape and fine-grained, sweet flesh. **Pkts. 5c and 10c; oz. 10c; ¼ lb. 20c; lb. 60c.**

GUERANDE, or OX HEART—Especially desirable for soil so hard and stiff that long-rooted sorts would not thrive in it. Tops comparatively small. Roots 4 to 5 inches long, very thick, ending abruptly in a small tap root. Flesh bright orange, fine-grained and sweet. When young the roots are excellent for table use, and when matured are equally good for stock feeding. **Pkts. 5c and 10c; oz. 10c; ¼ lb. 25c; lb. 75c.**

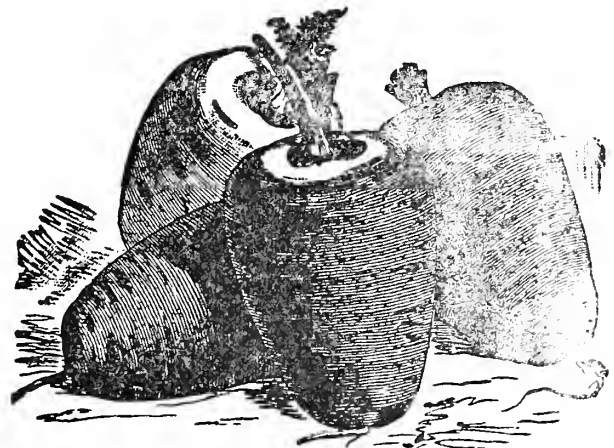

Guerande, or Ox Heart

CAULIFLOWER

CULTURE—For Spring and early Summer crop, sow in March or early in April in hotbed and transplant in cold frame when sufficiently large to handle. As soon as danger of hard freezing is over set in open ground in rows 2½ feet apart and 18 inches apart in the row. The plants will endure a light frost. The soil for Cauliflower should be like that for cabbage, but it is better if made richer. One ounce will produce 1,500 plants.

EXTRA-EARLY SNOWBALL—Unquestionably the earliest maturing strain of the true short-leaved Snowball type of Cauliflower.

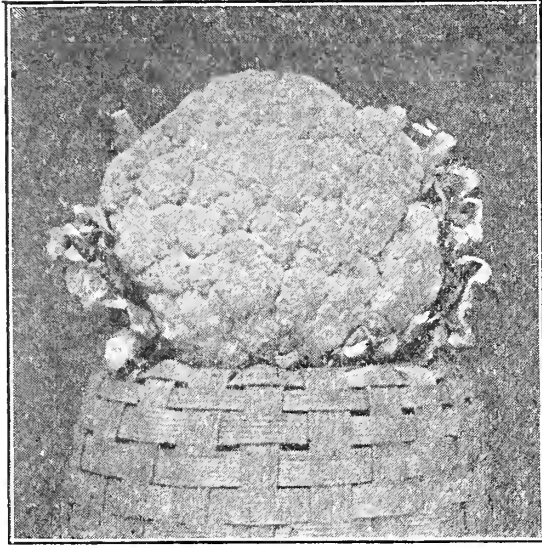

Admirably adapted for forcing or wintering over for early crop, and the most popular sort for these purposes, also one of the best sorts for late Summer and Fall crop. The plants are compact, with few short outside leaves, and are well suited for close planting. The heads are of medium to large size, solid, compact, round, very

white and curdlike, and are developed earlier than those of any other sort. **Pkts. 25c and 50c; oz. \$2.50.**

EXTRA-EARLY DWARF ERFURT—A remarkably sure-heading early Cauliflower. It is of dwarf habit with short outside leaves, and is similar in all respects to Early Snowball, and nearly as early. The heads, when ready for market, are of medium to large size; curd white, exceptionally deep and of finest quality. It will give excellent results either in the home garden or for market use, and is superior to most seed sold at higher prices. Where extreme earliness is not the greatest consideration, we recommend this strain, after having proven it far superior to most stocks offered as Snowball. **Pkts. 25c and 50c; oz. \$2.00.**

Market Gardeners, Institutions or Planters wishing Seeds in large quantities are requested to mail us a list of their wants. A letter of inquiry may save you dollars, if you are needing considerable quantities of seed.

DROUGHT-RESTING—Large, white solid heads, maturing a little later than the Snowball. The best for hot, dry weather. **Pkts. 25c and 50c; oz. \$2.50.**

EARLY PARIS—An excellent sort for early or late use. **Pkt. 25c; oz. \$1.75.**

CRESS

CURLED, or PEPPER GRASS—This small salad is much used with lettuce, to the flavor of which its warm, pungent taste makes a most agreeable addition. **Pkts. 5c and 10c; oz. 15c; ¼ lb. 35c.**

WATER CRESS—Highly esteemed as a salad during the Spring and Fall, and as a garnish for meats during the Winter. Seed may be started readily in pans or boxes of very moist earth, and the young plants transplanted to shallow water. **Pkts. 5c and 10c; oz. 40c; ¼ lb. \$1.25.**

CHIVES

(German, Schnittlauch)

This popular kitchen garden plant is indispensable for flavoring certain dishes. It imparts a mild onion taste, not, however, to such an extent as to render it objectionable. The plants are hardy and will last for years. Don't cut the plant too close when gathering. If desired for Winter use, lift the plant in a pot or box and place in a sunny window in the kitchen. **Pkts. 5c and 10c; oz. 25c.**

CORN SALAD

A favorite salad plant and very hardy. Sow in August or September, and protect with leaves during Winter. It can be gathered in the Spring very early. Sown in April, it is soon ready for use. The leaves are sometimes boiled and served as spinach. Three ounces of seed to 100 feet of row. **Pkts. 5c; oz. 10c; ¼ lb. 25c; lb. 75c.**

CHERVIL

An aromatic plant, used extensively in Europe as a salad seasoner. It adds a flavor that is entirely its own. When chopped fine and scattered on buttered potatoes it is a rare treat. American gardeners should become familiar with this, as they are missing one of the best things that grow. Sow it in a row like parsley, which it somewhat resembles. For a continuous crop, sow every 2 weeks. If one has heated frames or a greenhouse, it can be cut 4 or 5 weeks after sowing. One ounce will sow a row 25 feet long. **Pkts. 5c and 10c; oz. 35c; ¼ lb. \$1.00.**

PLANTS—Vegetable

We grow each year thousands of vegetable plants of all kinds, we furnishing the seed stock, thereby knowing the true varieties of each. These are looked after with the utmost care, and in shipping are packed in moss, in strong cases, so we can guarantee safe delivery to our customers. Our list includes the following:

BEET—Eclipse, Detroit Dark Red, Crosby Egyptian Blood Turnip and Egyptian Flat. **50c per 100; \$4.00 per 1,000.** Special price on larger quantities.

CABBAGE—Early Jersey Wakefield, Charleston Wakefield, Plain Flat Dutch, Early York, Succession, All Seasons, Drumhead Savoy and All-Head Early. **50c per 100; \$3.00 per 1,000.**

CELERY—Golden Heart, Winter Queen, Giant Pascal, Pink Plume, Boston Market and Golden Self-Blanching. **\$1.00 per 100; \$6.00 per 1,000.**

EGGPLANT—New York Improved, Black Beauty and Baltimore. Pot grown, **5c each; 50c per dozen; \$4.50 per 100.** From seed bed, **\$1.00 per 100; \$6.00 per 1,000.**

KOHL-RABI—**75c per 100; \$5.00 per 1,000.**

LETTUCE—All varieties. **50c per 100; \$4.00 per 1,000.**

BRUSSELS SPROUTS—**75c per 100; \$5.00 per 1,000.**

CAULIFLOWER—**\$1.00 per 100; \$7.50 per 1,000.**

SAGE—For flavoring (potted plants only). **10c each; \$1.00 per dozen.**

PARSLEY—For Fall or Spring planting. Strong, healthy roots. **\$1.00 per 100; \$5.00 per 1,000.**

PEPPERS—Bull Nose, Sweet, Mountain, Ruby King and other varieties. **\$1.00 per 100; \$6.00 per 1,000.**

SWEET POTATOES—All varieties. **50c per 100; \$3.50 per 1,000.**

TOMATO—Seed bed plants, **50c per 100; \$4.50 per 1,000.** Field grown, **40c per 100; \$3.00 per 1,000.** Special price quoted on larger quantities.

Prices above include such varieties as Bonnie Best, Red Rock, Greater Baltimore, New Stone, Brinton's Best, My Maryland, Paragon, Matchless, Chalk's Jewel, Beauty, and New Queen.

"WISDOM" and KELLY RED POTTED PLANTS, **5c each; 50c per dozen.** Hot-bed plants, **75c per 100; \$5.00 per 1,000.** Field grown, **60c per 100; \$4.00 per 1,000.**

NOTICE—Plants will not be forwarded C. O. D. Plants are not quoted by express prepaid; the customer pays express charges, and unless otherwise instructed, plants will be forwarded by express. Cash must accompany all orders for plants.

All Prices Subject to Change Without Notice

CELERY

(German, Sellerie; French, Celeri; Spanish, Apio)

CULTURE—Sow in hotbeds in March or in open ground in April. See that no weeds infest the seed bed. When 3 inches high transplant in a bed outdoors in rows 3 inches apart each way; let them remain here until July, when they should be planted where they are to mature, in rows 3 feet apart, 6 inches apart in the row. One ounce of seed will produce 2,000 plants.

DWARF GOLDEN HEART—This variety comes in for use at Christmas, and keeps well into the Spring. The stalk is short, stocky and very nutty. The heart or inner stalks are a rich golden yellow. An ideal home garden variety. **Pkts. 5c and 10c; oz. 15c; ¼ lb. 50c; lb. \$1.50.**

WHITE PLUME—It is the earliest Celery in cultivation. It is distinct from Golden Self-Blanching in being taller in growth, more slender in stalk, and branches to a pure snowy whiteness. It is a valuable market sort on account of its extreme earliness, but is not as good a keeper nor has it so fine a flavor as the Golden Self-Blanching. **Pkts. 5c and 10c; oz. 15c; ¼ lb. 50c; lb. \$1.50.**

WINTER QUEEN—A medium-tall, solid variety; will retain its qualities long through the Winter. The heart is very full and large. **Pkts. 5c and 10c; oz. 15c; ¼ lb. 50c; lb. \$1.50.**

GIANT PASCAL—One of the largest stalked kinds, with wonderful keeping qualities. It is in its prime for use during February and March, and can be used well up into Spring. Its flavor is fine and nutty; the stalks have no tendency to be stringy, and are enormously thick and meaty. **Pkts. 5c and 10c; oz. 15c; ¼ lb. 50c; lb. \$1.50.**

GOLDEN SELF-BLANCHING—One of the earliest and most productive sorts. The beautiful golden-colored stalks attain a height of 18 inches, which during the growing period are never pithy; of excellent flavor, requiring no artificial blanching process. Ready for use in October, but may be kept for early Winter use. **Pkts. 5c and 10c; oz. 40c; ¼ lb. \$1.25; lb. \$4.00.**

WHITE PLUME—The standard early Celery for market and the home garden. The stalks and heart, which blanch very quickly to almost a pure white, are very crisp and brittle. **Pkts. 5c and 10c; oz. 15c; ¼ lb. 50c; lb. \$1.50.**



PINK PLUME—A very solid, crisp, desirable sort. The stalks when blanched are a beautiful rose pink. On the table it is quite an attraction, and should be grown more extensively. It is very early and requires very little artificial blanching. **Pkts. 5c and 10c; oz. 15c; ¼ lb. 50c; lb. \$1.50.**

BOSTON MARKET—A very short, bushy variety, which blanches almost a pure white, with a distinct desirable flavor. **Pkts. 5c and 10c; oz. 15c; ¼ lb. 50c; lb. \$1.50.**

EXTRA-SELECT FRENCH GOLDEN SELF-BLANCHING

Our seed of this variety comes to us every season direct from the originator in France, and our rapidly increasing trade is abundant evidence of its high quality. It is now the leading sort on all markets as an early Celery. For market use it is preferred to White Plume, because it does not wilt so soon, and its rich yellow color is very attractive. The stalks are heavier, and it comes into market almost as soon as any other sort. It is of dwarf, compact habit and blanches readily. **We much regret that the crop this year is so nearly a failure that we can offer the true seed only in packets, ounces and quarter pounds. Prices, by mail, postpaid, pkt. 10c; ½ oz. 90c; oz. \$1.75; ¼ lb. \$7.00.**

CELERIAC

Grown extensively for the roots, which are turnip-shaped, very smooth, tender and marrowlike.

LARGE SMOOTH PRAGUE—This is unquestionably the largest and best Celeriac in existence. **Pkts. 5c and 10c; oz. 20c; ¼ lb. 75c.**

CELERY PLANTS—(See page 8.)

SWEET, or SUGAR CORN

CULTURE—Sugar Corn can be raised on any good, ordinary soil if it is deeply and well worked before planting. Give frequent and thorough but shallow cultivation until the tassels appear. Plant in rows about 3 or 4 feet apart and about 3 feet apart in the row. Leave not more than 3 plants to the hill. It can be planted from first of May to last of July for a succession of crop.

ADAM'S EXTRA EARLY—Pure white, medium-sized ears. Not a sugar corn. Planted extensively by market gardeners, as it matures in about 65 days after germination. **Pt. 15c; Qt. 25c; Pk. \$1.25; Bu. \$4.00.**

ADAM'S EARLY—Pure white, ears a trifle larger than Adam's Extra Early. Matures about 10 days later. **Pt. 15c; Qt. 25c; Pk. \$1.25; Bu. \$4.00.**

WHITE COB CORY—One of the very best extra-early sorts for the market and home garden. Selected for white cob and white kernels from the original and earliest Cory. **Pt. 15c; Qt. 25c; Pk. \$1.25; Bu. \$4.00.**

EARLY CROSBY—A most excellent second-early variety. Ears large size, 12-rowed, medium length; grain thick and sweet; sure to give satisfaction; fine for drying. **Pt. 15c; Qt. 25c; Pk. \$1.25; Bu. \$4.00.**

EARLY SHEFFIELD—This is one of the standard old varieties that has become wonderfully popular, both in quality and yield it is sure to delight all lovers of choice early Sweet Corn. **Pt. 15c; Qt. 25c; Pk. \$1.25; Bu. \$4.00.**

PEEP-O'-DAY—A new variety, of extraordinary earliness and superior sweetness, equaling the larger and later varieties. Wonderfully productive, owing to the fact that the stalks bear from 2 to 3 ears each. The originator claims for this variety that it sometimes yields almost double as much as other sorts. Very popular and profitable to market gardeners, owing to its earliness, productiveness and beauty. **Pt. 15c; Qt. 25c; Pk. \$1.25; Bu. \$4.00.**

PREMO—Ears from 5 to 7 inches long and of fine shape for a first sort. We confidently recommend it to all gardeners, as its earliness and table quality will speedily bring it into favor. **Pt. 15c; Qt. 25c; Pk. \$1.25; Bu. \$4.00.**

EARLY EVERGREEN—A fine new sort; identical in flavor, shape and size of grain with Stowell's Evergreen, but about 10 days earlier. The ears grow about 9 inches long, are mostly 12-rowed, and remain tender a remarkably long time. It is a splendid sort for truckers and private gardeners, as it furnishes a succession to the second early sorts. **Pt. 15c; Qt. 25c; Pk. \$1.25; Bu. \$4.00.**

All Prices Subject to Change Without Notice

GOLDEN BANTAM—This is a Sweet Corn of most exquisite quality, which, when ready to use, is of a bright golden yellow color. It looks rich, and it is rich, and no mistake. It can be planted very early, as it is hardy as the Extra-Early Adam's. The small stalks can grow very closely together in the row and will produce 2 to 3 ears each. **Pt. 15c; Qt. 25c; Pk. \$1.50.**

EARLY MAMMOTH—Really a second-early variety, producing enormous ears on a mammoth stalk. **Pt. 15c; Qt. 25c; Pk. \$1.25; Bu. \$4.00.**

BLACK MEXICAN—Very sweet, sugary flavor. Ears about 7 inches long. Color black. **Pt. 15c; Qt. 25c; Pk. \$1.50.**

SHAKERS EARLY—This is a very desirable sort for market gardeners as well as the home garden, as it matures very early. Very productive, often growing 4 ears to a stalk. The ears are large and well filled with long, narrow grains. **Pt. 15c; Qt. 25c; Pk. \$1.25; Bu. \$4.00.**

HICKOX—A very handsome and showy sort. Large ears, large white grain, a splendid variety for market gardeners. **Pt. 15c; Qt. 25c; Pk. \$1.25; Bu. \$4.00.**

NINETY-DAY RED COB—This sort, while not a sugar corn, is planted almost exclusively as a table corn. It matures in 90 days, and if weather conditions are just right, will often be ready to cut in 80 to 85 days. Cob red, ears large, grain large, white. **Pt. 15c; Qt. 25c; Pk. \$1.00; Bu. \$3.75.**

COUNTRY GENTLEMAN—The ears are somewhat smaller and less showy than the coarser varieties, but for private family use, where quality is preferred to size, it has no equal. The cob is very small, giving great depth to the grain. Matures about the same time as Stowell's Evergreen. **Pt. 15c; Qt. 25c; Pk. \$1.25; Bu. \$4.00.**

STOWELL'S EVERGREEN—The most popular of all. If planted at the same time with earlier kinds will keep the table supplied until October. It is hardy and productive, very tender and sugary, remaining a long time in a fresh condition for cooking. In fact, it is so well known that it needs no further description. **Pt. 15c; Qt. 25c; Pk. \$1.25; Bu. \$4.00.**

EARLY CHAMPION—An excellent second-early sort, as sweet as any variety, Golden Bantam and Country Gentleman not excepted. Yields more than any other early variety; ready for use in 70 days after planting. The ears are 6 to 8 inches long, 12-rowed, and kernels pure white. Very large and deep for an early corn; grows about 5 to 6 feet high, usually with two ears to the stalk. It is superior to most other corns in quality and is a few days earlier than Minnesota. More prolific, larger ear, deeper kernels. For home use and when dried it is remarkably sweet and tender. Market gardeners will find it most desirable and profitable on account of its being an early Sweet Corn of large size and very productive. Many plant the Early Champion at intervals of 2 weeks in order to have a succession of it the whole season, preferring it for the table to any of the later sorts. **Pt. 15c; Qt. 25c; Pk. \$1.25; Bu. \$4.00.**

ZIG-ZAG EVERGREEN—This fine new strain possesses the distinct characteristics which have made Stowell's Evergreen so deservedly the favorite for main crop, but produces ears fit to use from 1 week to 10 days earlier. **Pt. 15c; Qt. 25c; Pk. \$1.25; Bu. \$4.00.**

KENDEL'S EARLY GIANT—The ears average 8 to 10 inches long and carry an average of about 12 rows. Kernels are pure white and are very sweet, tender and of fine table quality. Kendel's Early Giant is very prolific and reaches remarkable size in about 65 days. This variety is especially adapted to light sandy soil. **Pt. 15c; Qt. 25c; Pk. \$1.25; Bu. \$4.00.**

EGYPTIAN, or WASHINGTON MARKET—A standard variety, in season between Evergreen and Mammoth Sugar. Very sweet and well adapted for canning. **Pt. 15c; Qt. 25c; Pk. \$1.25; Bu. \$4.00.**

OLD COLONY—This variety is 2 weeks earlier than the Evergreen and almost as large. It is considered the best and sweetest by canning factories. A fine paying variety for market. **Pt. 15c; Qt. 25c; Pk. \$1.25; Bu. \$4.00.**

WHITE EVERGREEN—This is a high-bred white-type Stowell's Evergreen. It has been developed by careful work, only the finest white-eared product being saved and selected each season. The stalks are of strong, vigorous growth, 6 to 7 feet high. **Pt. 15c; Qt. 25c; Pk. \$1.25; Bu. \$4.00.**

GOLDEN QUEEN POP CORN—For planting or popping. **Lb. 10c; 10 lbs. 75c.**



Stowell's Evergreen

"The Stowell's Evergreen Corn purchased from you turned out the best crop I ever had, ears weighing from two to two and a half pounds and fifteen inches long. I exhibited a few ears at the Sun Office, where it attracted considerable attention."—HENRY GEHRING, Woodlawn, Md.

We make every effort to procure, and have grown for us, the very best Sugar Corn Seed Stock, paying the strictest attention to the types of the different varieties, time and maturity, length of ears, color of grain, sweetness, etc., and can assure the buyer corn that is absolutely true to name and of excellent germinating quality. However, no matter how well sugar corn has been selected and cured, if left in bulk will gather moisture and spoil. In order to prevent this we would advise our customers to take it out of bag or package as soon as received and spread in a warm dry place.

All Prices Subject to Change Without Notice

CUCUMBER

(German, Gurken; French, Coucombre; Spanish, Pepino)

CULTURE—Cucumbers succeed best in rich loamy soil. As soon as the weather becomes warm and settled, plant in hills 4 to 6 feet apart each way, with 10 to 12 seeds in a hill; cover $\frac{1}{2}$ inch deep. Air-slaked lime sprinkled on the plants every few days as soon as they are up will protect them from the striped beetle. When 3 or 4 inches high, thin out plants, leaving 3 or 4 of the strongest to each hill. The fruit should be picked when large enough, otherwise it destroys the productiveness. One ounce to 50 hills; 2 pounds per acre.

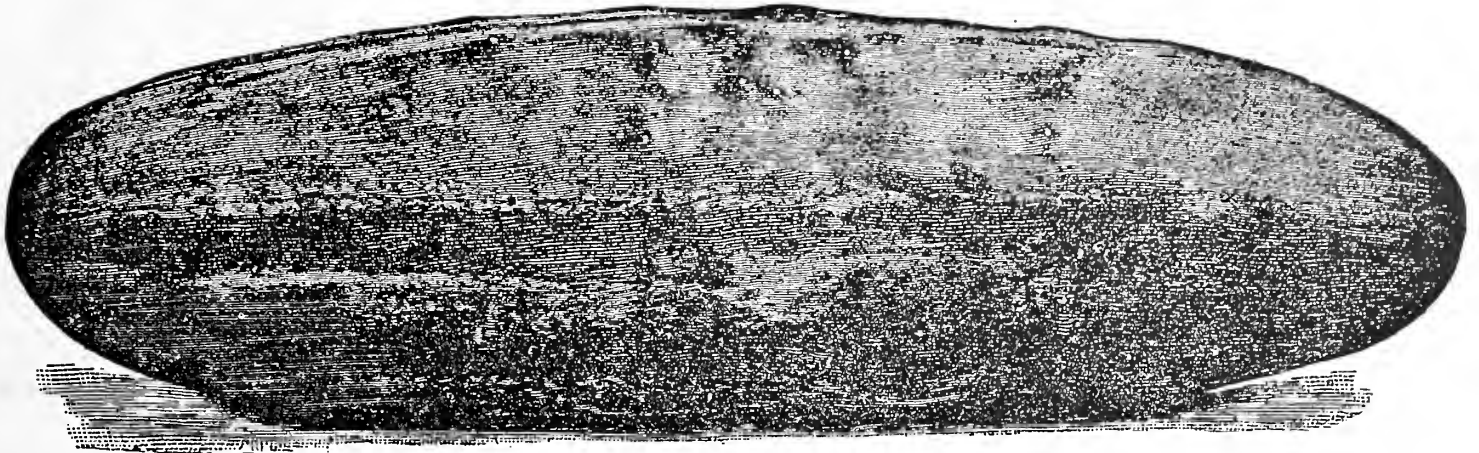

W. D. Co.'s O. K. Cucumber

W. D. CO.'S O. K.—In this variety we have secured the finest strain (even exceeding the Klondike, or White Spines) that has ever been grown. Our grower in Colorado, whose specialties are Cucumbers and Cantaloupes, says: "It is the Cucumber par excellence." Early, producing a very abundant crop of fruit, 9 to 10 inches long. The flesh is thick; seed cavity relatively small, with few seeds; color rich dark green, which does not fade nor turn yellow when shipped a long distance. It is tender and crisp, making it fine for slicing. The fruit is slightly longer than either the "Klondike, or White Spine," more cylindrical in shape. A remarkable feature of this variety is the strong growth of vines which enables it to withstand blight and bring the fruits to their full size and perfection, a very important quality, which will appeal to both trucker and home gardener. **Pkts. 5c and 10c; oz. 15c; $\frac{1}{4}$ lb. 40c; lb. \$1.25.**

KLONDIKE—This is a true and distinct sort, not to be compared with the White Spine. It is entirely different, in that it holds its greenish color longer, is earlier and has a much better appearance. It is the best for truckers as well as for the home garden. One trucker in Anne Arundel County, Md., says: "The best crop of Cucumbers I ever had," and we can say that this is the sentiment of all who have tried this wonderful sort. **Pkts. 5c and 10c; oz. 15c; $\frac{1}{4}$ lb. 40c; lb. \$1.00.**

IMPROVED LONG GREEN—Of excellent quality, dark green, firm and crisp. Very popular with the market gardeners. A standard pickling sort. **Pkts. 5c; oz. 10c; $\frac{1}{4}$ lb. 25c; lb. 75c.**

JERSEY PICKLING—Very popular with market gardeners. Medium length, with large and prominent spines. Color deep green; very prolific. **Pkts. 5c; oz. 10c; $\frac{1}{4}$ lb. 25c; lb. 75c.**

EVERBEARING—This is one of the most productive sorts. Fruit can be picked throughout the entire season. The vine is hardy and will continue to flower and bear fruit until killed by frost. Fruit small, very early. **Pkts. 5c; oz. 10c; $\frac{1}{4}$ lb. 25c; lb. 75c.**

ARLINGTON WHITE SPINE—This strain of White Spine has been improved by careful selection. Rich green color, and a very prolific bearer. **Pkts. 5c; oz. 10c; $\frac{1}{4}$ lb. 25c; lb. 75c.**

EARLY GREEN PROLIFIC—A very productive variety, having fruits of good length and handsome form. Desirable for producing pickles of medium size and of fine quality when sliced for the table. **Pkts. 5c; oz. 10c; $\frac{1}{4}$ lb. 25c; lb. 75c.**

CUMBERLAND—This splendid sort, introduced a few years ago, has certainly held its own, and is now one of the best standard sorts. Said to have originated from crossing the Parisian Pickling and the Early White Spine. It certainly has the good qualities of both of these sorts. Large symmetrical, dark green fruit, covered with innumerable small white spines. Excellent for slicing. **Pkts. 5c; oz. 10c; $\frac{1}{4}$ lb. 25c; lb. 75c.**

CHICAGO, or WESTERFIELD PICKLING—Fruit of medium length, pointed at each end, with very large and prominent spines; color deep green. A very prolific

variety and one of the best for those who want crisp, coarsely spined pickles. **Pkts. 5c; oz. 10c; $\frac{1}{4}$ lb. 25c; lb. 75c.**

SMALL GHERKIN (for Pickles)—A very small, oval, prickly fruited sort, quite distinct from all others and grown exclusively for pickles. It is the smallest of all the varieties, and should always be picked when young and tender. Seed distinctly smaller than other Cucumbers, and is slow to germinate, requiring usually from 2 to 3 weeks. **Pkts. 5c; oz. 10c; $\frac{1}{4}$ lb. 35c; lb. \$1.00.**

EGGPLANT

(German, Fierpflauze; French, Aubergino; Spanish, Bereugena)

CULTURE—Eggplant seed germinates slowly and should be started in hotbed, for in this, as in all subtropical plants, it is of importance to secure a rapid and continuous growth from the first, the plants never recovering from a check received when young. When the plants have formed 2 rough leaves, transplant to 3 or 4 inches apart. When all danger, not only of frost, but from cold nights is past, harden off the plants by gradual exposure to the sun and air, and decreasing the supply of water; then transplant to the open ground, setting the plants $2\frac{1}{2}$ feet apart. One ounce will produce about 1,000 plants.

BLACK BEAUTY—Fruits large, symmetrical in shape and uniformly of a rich dark purple color, which it holds an exceptionally long time, making the variety very desirable for the market. Fruit matures a little earlier than our Improved Large Purple, but are usually not quite as large. **Pkts. 5c and 10c; oz. 40c; $\frac{1}{4}$ lb. \$1.50.**

NEW YORK IMPROVED LARGE PURPLE EGGPLANT (Spineless)

This variety is a general favorite both for market and home garden. Plants spineless, large and spreading, with light green foliage. Usually produces 4 to 6 large, oval fruits of a splendid dark purple color. Early, productive and of excellent quality. The vigor and productiveness of the plant and the large size and fine quality of its fruit make it most profitable for market gardeners. **Pkts. 5c and 10c; oz. 40c; $\frac{1}{4}$ lb. \$1.50.**

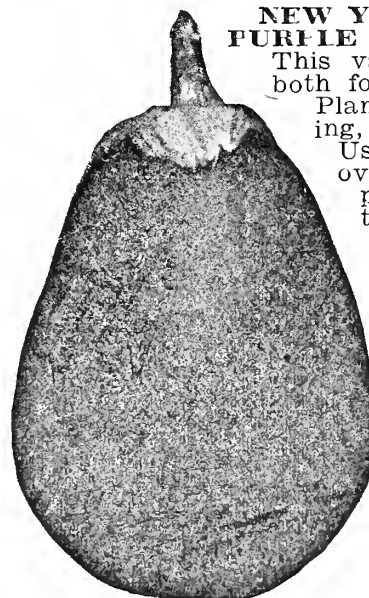

New York improved Large Purple

BALTIMORE—Large fruit, thornless, of beautiful shape and handsome color. One of the best and most profitable Eggplants in cultivation. **Pkts. 5c and 10c; oz. 40c; $\frac{1}{4}$ lb. \$1.50.**

Best by Every Test

ENDIVE

(German, Endive; French, Chicoree;
Spanish, Enoiuia o Escarold)

CULTURE—Endive is an excellent Autumn and Winter salad. Sow seed late in the Spring, or even as late as July, in shallow drills, 15 inches apart, and when plants are strong thin out to about a foot apart. To blanch, gather up the outer leaves over the center of the plant and tie them together at their tips. Sow 1 ounce to 100 feet of drill.

GREEN CURLED—The hardiest variety. Leaves dark green, finely cut; easily blanched to a fine white. **Pkts. 5c and 10c; oz. 15c; ¼ lb. 40c; lb. \$1.50.**

BROAD-LEAVED BATAVIAN—Leaves large, broad, slightly curled. Tie up for blanching. **Pkts. 5c and 10c; oz. 15c; ¼ lb. 40c; lb. \$1.50.**

KALE

(German, Blaetter-Kohn; French Chou Vert;
Spanish, Breton)

Extensively grown in this locality and also in the South during the Fall, Winter and Spring. The plant is more hardy than cabbage, and makes excellent greens for Winter and Spring use. The quality is improved rather than injured by frost. One ounce of seed will sow a drill of about 150 feet.

SIBERIAN CURLED KALE—A finely curled, spreading, low-growing variety. The leaves, when properly cooked, make a very palatable dish of greens. The plant is very hardy. The leaves are long and of an attractive, bright green color. **Pkt. 5c; oz. 10c; ¼ lb. 15c; lb. 40c.**

EXTRA-CURLED NEW AMERICAN KALE—Long standing, extra curled and of a beautiful greenish color. **Pkt. 5c; oz. 10c; ¼ lb. 15c; lb. 40c.**

NORFOLK KALE—Grown extensively by Norfolk truckers. Leaves very much curled and of a light green color. **Pkts. 5c and 10c; oz. 15c; ¼ lb. 50c; lb. \$1.50.**

TALL GREEN CURLED SCOTCH—Grows 3 or 4 feet high, bearing long, plumelike light green leaves, deeply cut, finely curled at edges. Very ornamental and so hardy that a moderately heavy frost improves rather than injures its quality. **Pkts. 5c and 10c; oz. 15c; ¼ lb. 50c; lb. \$1.50.**

DWARF CURLED SCOTCH—Plant low and compact, but with large, bright, deep green leaves, curled, cut and crimped until the whole plant resembles a bunch of moss. One of the best sorts for use when well grown and cooked is one of the most palatable of vegetables. **Pkts. 5c and 10c; oz. 15c; ¼ lb. 50c; lb. \$1.50.**

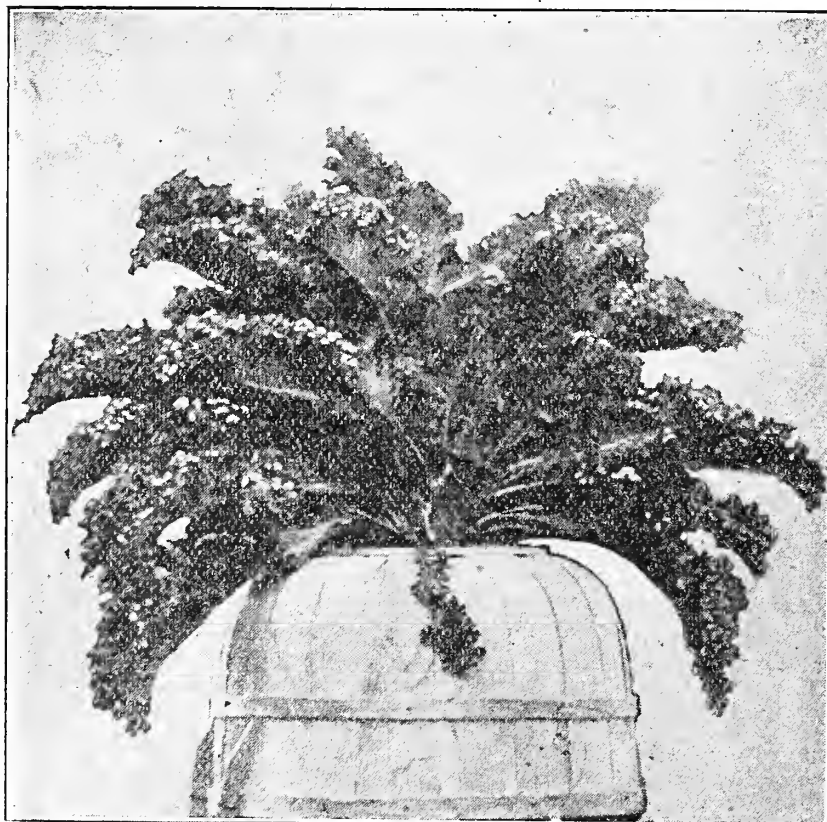

Siberian Curled Kale

GERMAN CURLED—In this variety the very large green leaves are comparatively plain in the center, but coarsely cut and frilled on the edge. The plant is low but spreading and very hardy. **Pkt. 5c; oz. 10c; ¼ lb. 15c; lb. 40c.**

KOHL-RABI

(German, Kohl-Rabi; French, Chou Rave;
Spanish, Colde Nabo o Nabicol)

CULTURE—This is a favorite vegetable in Europe, where it is extensively grown for feeding cattle as well as for table use. The bulb is formed above the ground, and if used when young and tender, makes a most delicate dish for the table. One ounce will sow 150 feet of drill.

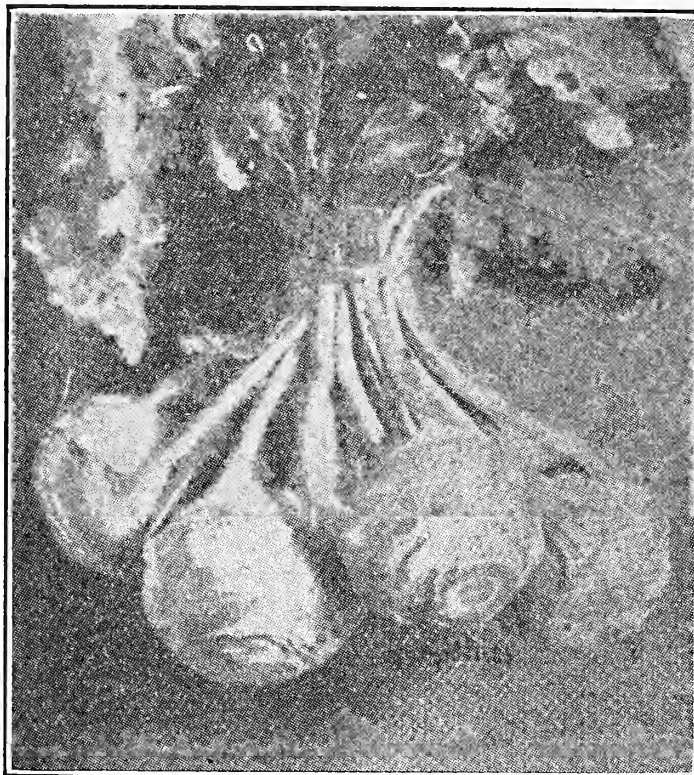

EARLIEST WHITE VIENNA—Greenish-white outside, with clear white flesh within. Smooth short leaf; good for forcing; fine quality. **Pkts. 5c and 10c; oz. 15c; ¼ lb. 50c; lb. \$1.50.**

EARLIEST PURPLE VIENNA—Same in every respect as the Earliest White Vienna, except in the outside color. **Pkts. 5c and 10c; oz. 15c; ¼ lb. 50c; lb. \$1.50.**

LEEK

(German, Lauch, French, Poireau;
Spanish, Puerro)

CULTURE—Sow the seed and care for the young plants same as for onions, but they need a little more room in order to develop fully. When the young plants are about the size of a goose quill transplant into a prepared bed in rows 1 foot apart and 4 to 5 inches in the rows. Set the roots deep and draw the earth to them when cultivating, so that they may be well blanched by the time they are fit for use. One ounce to 150 feet of row.

LARGE AMERICAN—Produces a large, thick stem and of mild flavor. **Pkts. 5c and 10c; oz. 20c; ¼ lb. 60c; lb. \$2.25.**

LONDON FLAG—One of the hardiest and best for Winter use. **Pkts. 5c and 10c; oz. 20c; ¼ lb. 60c; lb. \$2.25.**

MUSTARD

(German, Snef; French, Moutarde;
Spanish, Mustazo)

WHITE MUSTARD—For salads and culinary purposes. **Pkt. 5c; oz. 10c; ¼ lb. 15c; lb. 50c.**

BROWN MUSTARD—Stronger than above. Price same as white.

LETTUCE

(German, Lattich; French, Laitue; Spanish, Lechuca)

CULTURE—Lettuce, to be at its best, should be grown as rapidly as possible; hence the soil should be made as rich and friable as possible by liberal manuring and thorough preparation. For Winter, sow under glass from November to February and thin out as necessary to prevent crowding. Keep a moderate heat and give all the light and air possible. For general crop, sow outdoors as early in the Spring as the ground can be worked, in drills 18 inches apart, and thin the young plants to 4 inches apart in the row. As the plants begin to crowd thin them out and use as required. In this way a much longer succession of cuttings may be had from the same ground. One ounce of seed for 2,000 plants.

WISEMAN-DOWNS CO.'S NEW IDEAL HEAD LETTUCE—After experimenting with this wonderful variety for several years we feel that we have at last a head lettuce which is truly the best for truckers as well as for the home garden. Those who were fortunate enough to get some of the seed the past season say, "It is the best they have ever grown." The plants are of quick growth, practically all head and extremely handsome. From Early Spring plantings in the open ground they grow quickly to a diameter of 8 to 9 inches, with the broad, light green outer leaves folding closely about the round solid head. It is one of the best heat-resisting lettuces on the market, remaining in head without running to seed. We can highly recommend this sort for Spring or Fall planting. **Pkts. 5c and 10c; oz. 25c; ¼ lb. 75c; lb. \$2.50.**

HANSON (Seed White)—One of the most desirable later Summer Lettuces. The plant is compact and forms a large, cabbage-like head, which remains in condition longer than most heading sorts. Outer leaves bright yellowish-green, broad, somewhat crumpled and frilled at edge and with distinctive midrib. Inner leaves white, very crisp and sweet. **Pkts. 5c and 10c; oz. 20c; ¼ lb. 50c; lb. \$1.50.**

GRAND RAPIDS—As a lettuce for greenhouse forcing, this variety undoubtedly stands at the head of the list, being of quick growth, hardy, little liable to rot and remaining in condition several days after being fit to cut. The plant is upright and forms a loose cluster of large, thin, bright green leaves, savoyed, finely crimped at edges. The leaves do not wilt quickly after cutting, so that the variety will stand shipping long distances better than most sorts. Very attractive and desirable for garnishing. **Pkts. 5c and 10c; oz. 20c; ¼ lb. 50c; lb. \$1.50.**

SIMPSON'S EARLY CURLED (Seed White)—Leaves light green, slightly frilled and much blistered, crisp, sweet and tender. Especially adapted for sowing thickly and cutting when the plants are young. **Pkts. 5c and 10c; oz. 20c; ¼ lb. 50c; lb. \$1.50.**

BLACK-SEEDED SIMPSON—One of the best for sowing outdoors where an exceedingly tender leaf is desired. Leaves ruffled and blistered, and even the large outer ones are very tender. **Pkts. 5c and 10c; oz. 20c; ¼ lb. 50c; lb. \$1.50.**

PRIZE HEAD—Leaves finely curled and crumpled, bright green, tinged with brownish-red; very crisp, tender and sweet. **Pkts. 5c and 10c; oz. 20c; ¼ lb. 50c; lb. \$1.50.**

PARIS WHITE COS (Romaine)—Cos Lettuce is distinct in having long, narrow, spoon-shaped leaves, folding into loose, sugar loaf-shaped heads, which blanch better by having the outer leaves drawn about them and tied. **Pkts. 5c and 10c; oz. 20c; ¼ lb. 50c; lb. \$1.50.**

SALAMANDER (Seed Black)—A large, compact, light green head, of excellent quality. The leaves are broad, thick, somewhat crumpled and closely overlapping, so that the inner ones are very finely blanched. The variety withstands hot weather remarkably well. It is one of the most satisfactory heading Lettuces for growing outdoors. **Pkts. 5c and 10c; oz. 20c; ¼ lb. 50c; lb. \$1.50.**

LARGE LOAF LETTUCE—This is extensively grown by the truckers of Baltimore County as well as around Norfolk. Plants are large and vigorous. Compact heads, broad leaves of a beautiful greenish color, very tender and crisp. Uniformly attractive and remains of excellent quality for a long time. **Pkts. 5c and 10c; oz. 20c; ¼ lb. 50c; lb. \$1.50.**

BIG BOSTON (Seed White)—Popular for outdoor culture; also much in demand as a compact, large-heading, forcing sort. Plants large, very hardy and vigorous. Leaves broad, comparatively smooth, but wavy at edge, thin, very hard and crisp. Color bright light green, the head slightly tinged with reddish-brown. Grown extensively in the South for shipment North in the Winter. It usually heads up under cold weather conditions better than any other variety, and we therefore heartily recommend it, especially to the market gardening trade. **Pkts. 5c and 10c; oz. 20c; ¼ lb. 50c; lb. \$1.50.**

MAY KING (Seed White)—A handsome, extremely early, compact, cabbage or heading variety, forming very firm heads of medium size and excellent quality. Color light yellowish-green, tinged with reddish-brown when mature. Inner leaves blanch rich golden yellow; very tender and buttery. Plant very compact for so large a head. Exceptionally early outdoors, attaining a size suitable for use before other sorts, and also very satisfactory for forcing. **Pkts. 5c and 10c; oz. 20c; ¼ lb. 50c; lb. \$1.50.**

BALTIMORE OAK LEAF—This Lettuce will resist the heat of Summer and stand longer before running to seed than any variety we have ever known. It makes a large, solid head, and is very popular with those who know it. **Pkt. 10c; oz. 20; ¼ lb. 50c; lb. \$1.50.**

BALTIMORE CABBAGE LETTUCE—One of the best for Fall planting. Forms large solid heads of a beautiful light green color. Slow going to seed. Will stand heat well. **Pkts. 5c and 10c; oz. 20c; ¼ lb. 50c; lb. \$1.50.**

WHITE-SEED SUMMER—Will stand the summer heat better than most sorts, and will make beautiful solid heads. Leaves are of a beautiful green and are very tender and buttery. **Pkts. 5c 10c; oz. 20c; ¼ lb. 50c; lb. \$1.50.**

DEFIANCE—This sort stands the Summer heat better than any other. Forms very large and firm heads. **Pkts. 5c and 10c; oz. 20c; ¼ lb. 50c; lb. \$1.50.**

MAMMOTH BLACK-SEEDED BUTTER—A smooth-leaved Lettuce, forming very large, compact, cabbage-like heads of thick yellowish-green leaves, the inner ones beautifully blanched; very crisp, tender and buttery. **Pkts. 5c and 10c; oz. 20c; ¼ lb. 50c; lb. \$1.50.**

BIG HEAD—This certainly is rightly named, as it is the largest heading variety. Very solid and crisp, tender and of excellent flavor. **Pkts. 5c and 10c; oz. 20c; ¼ lb. 50c; lb. \$1.50.**



Large Loaf Lettuce



New Ideal Lettuce

WATERMELON

(German, Wasser Melone; French, Melone d'Eau; Spanish, Zandia)

CULTURE—Watermelons require a rich sandy loam, which should be well worked. Put 10 to 12 seeds in a hill. When the plants have formed the first pair of rough leaves they should be thinned so as to leave 2 or 3 of the strongest and best to each hill. Make hills about 10 feet apart. One ounce of seed to 30 hills.

TOM WATSON—This new melon has surprised everybody by its sudden rise in popularity. Although very new, it already occupies a very prominent place in all markets and is everywhere called for. It is a long green variety, covered with a fine netting, giving it a most attractive appearance. The flesh is of most superb quality and intensely red color. The rind is thin, but hard and tough, making it an excellent market and shipping sort. **Pkt. 5c; oz. 10c; ¼ lb. 25c; lb. 75c.**

FLORIDA FAVORITE—A standard sort. Long and of uniform size. Color a beautiful green. Flesh very red, with a taste that lingers. It has long been a favorite with the truckers and market gardeners. **Pkt. 5c; oz. 10c; ¼ lb. 20c; lb. 60c.**

KLECKLY SWEETS—Well does it deserve its name. It has a sweetness peculiarly all its own. The skin is a rich dark green; the flesh bright scarlet, ripening close to the rind. The melons average about 20 inches long and ripen quite early. Our strain is from the original stock, and we can recommend it very highly. **Pkt. 5c; oz. 10c; ¼ lb. 20c; lb. 60c.**

FORDHOOK EARLY—An extra-early melon of fine flavor and large size. Color a uniform medium green. Flesh bright red and sweet. **Pkt. 5c; oz. 10c; ¼ lb. 20c; lb. 60c.**

McIVER'S, or WONDERFUL SUGAR—Oblong in shape and uniformly large. The flesh is of a soft pale pink, crisp and juicy. The melons have a solid heart, free from cracks. **Pkt. 5c; oz. 10c; ¼ lb. 20c; lb. 60c.**

LORD BALTIMORE—Very large, of oblong shape. Very sweet, and of a beautiful crimson color. Thin, hard rind. Good shipper. **Pkt. 5c; oz. 10c; ¼ lb. 20c; lb. 60c.**

DIXIE—A popular market sort; vine vigorous, large growing and hardy; fruit medium-sized to large, about ⅓ longer than thick. Color of skin dark green striped with a lighter shade rind, thin but tough; flesh bright scarlet, ripens close to the rind, is of best quality and free from the hard, coarse center which is so objectionable a feature of many shipping melons. **Pkt. 5c; oz. 10c; ¼ lb. 20c; lb. 75c.**

PRESERVING CITRON, or MELON—A large-fruited variety, pure white flesh and thin rind. This is expensive when bought, yet can be grown and preserved

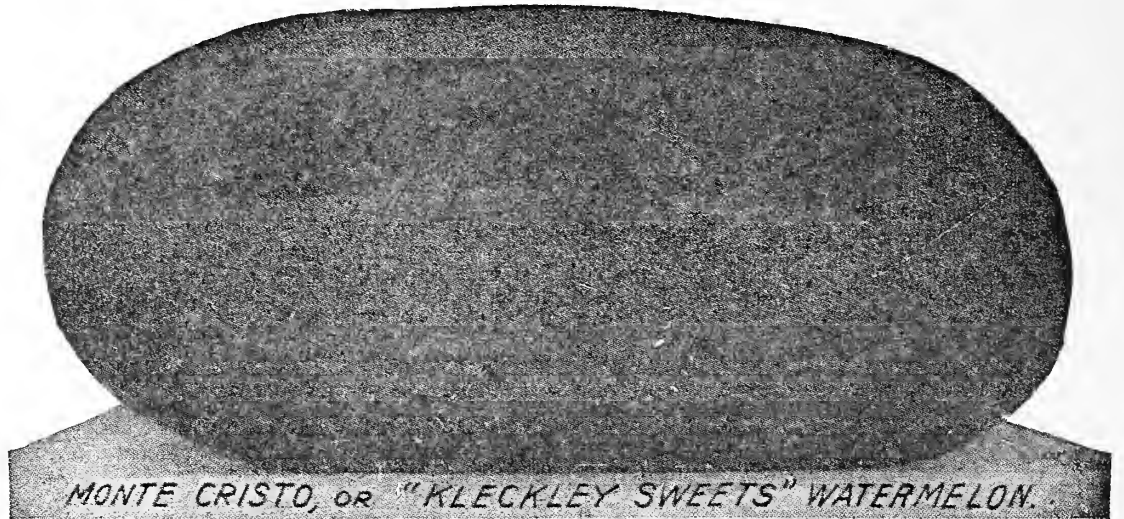

by any energetic housewife, who will then also know it to be absolutely pure and good. It is planted like Watermelon. Red-seeded. **Pkt. 5c; oz. 10c; ¼ lb. 25c; lb. 75c.**

TRIUMPH—Very early, very prolific and of uniform size. Cross between the Duke Jones and the Kolb Gem, and has the good qualities of both. **Pkt. 5c; oz. 10c; ¼ lb. 20c; lb. 60c.**

KOLB'S GEM—Vines of medium size, but remarkably vigorous and healthy. Leaves of medium size, deeply cut, with a peculiar frilled edge. Fruit of the largest size, round or slightly oval, marked with irregular mottled stripes exceedingly light green. Outer rind or shell is dark, hard and firm, making it a good sort for shipping long distances. Flesh bright red, solid, a little coarse, but sweet and tender. **Pkt. 5c; oz. 10c; ¼ lb. 20c; lb. 60c.**

LIGHT ICING—Flesh bright red, outside color very light green; round in shape, similar to Dark Icing, except the color of the rind. **Pkt. 5c; oz. 10c; ¼ lb. 20c; lb. 60c.**

SWEET HEART—Fruit large, oval, mottled light and dark green. Flesh bright red, solid, tender and sweet. **Pkt. 5c; oz. 10c; ¼ lb. 20c; lb. 60c.**

GYPSY, or GEORGIA RATTLESNAKE—One of the largest varieties and stands shipment long distances. Fruit cylindrical, square at the ends, smooth, distinctly striped and mottled light and dark green. Flesh bright scarlet and very sweet. **Pkt. 5c; oz. 10c; ¼ lb. 20c; lb. 60c.**

MUSKMELON

(German, Melone; French, Melone Muscade; Spanish, Melone Almizcleon)

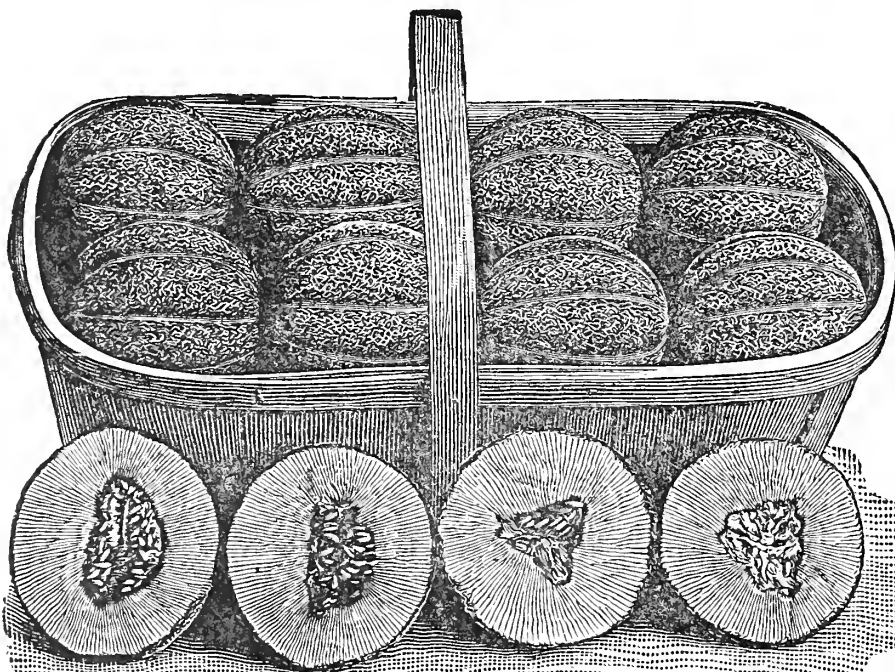

Rocky Ford Melon

CULTURE—Plant the seeds in hills 6 feet apart each way, dropping 10 to 12 seeds in a hill. After the plants begin to crowd and the striped beetles are pretty well gone, thin to 4 of the most vigorous plants in a hill. Give frequent but shallow cultivation until the plants make runners so long that this is impracticable. Rich earth for the young plants is far better than manure, but if the latter must be used, see that it is well rotted and thoroughly mixed with the soil. If the plants grow very rank, more and finer fruit will be secured by allowing the main branch to continue growing but pinch off the end of each side branch after it has one fruit set. One ounce of seed to 50 hills.

ROCKY FORD—One of the earliest and best melons grown. The vines are exceedingly healthy and vigorous, comparatively short and branching producing an enormous quantity of fruits during the season. The melons are very uniform in size and shape, being nearly round or slightly oval. Skin a rich greenish gold when fully ripe; the netting is fine and prominent. In appearance the melon is very attractive. The flesh is light green in color, very deep, ripening clear to the rind, which is very thin. In flavor it is peculiarly rich, luscious and free from stringiness. **Pkt. 5c; oz. 15c; ¼ lb. 40c; lb. \$1.25.**

EXTRA-EARLY KNIGHT—Slightly larger than the "Rocky Ford," but more heavily netted. The seed cavity is small and flesh, which is green, thick and sweet, containing a high percentage of sugar. An important feature of this melon is its ability to withstand rust and blight, as it is nearly proof against either. **Pkt. 5c; oz. 15c; ¼ lb. 50c; lb. \$1.50.**

FORDHOOK—An extra-early salmon-fleshed variety, which is very attractive in appearance and of delicious flavor. Medium size, heavily netted, and thick, juicy flesh. **Pkt. 5c; oz. 15c; ¼ lb. 40c; lb. \$1.25.**

ANNEARUNDEL—Large, green-fleshed, deeply netted. A good shipping melon. **Pkt. 5c; oz. 15c; ¼ lb. 40c; lb. \$1.25.**

WOOD'S—Oblong in shape, green-fleshed, excellent flavor, heavily netted and very small seed cavity. **Pkt. 5c; oz. 10c; ¼ lb. 40c; lb. \$1.25.**

HONEY DEW—The melon with an appropriate name. This new melon is unlike the ordinary Muskmelon or Cantaloupe, both in appearance and flavor, the outer skin being smooth, hard and nearly white. The melons are large, round to oval in shape, extremely thick-meated and have a very small seed cavity; flesh is light green, very solid and of a rich honey-like flavor, luscious and juicy. Of good keeping qualities and a good shipper. **Pkts. 5c and 10c; oz. 15c; ¼ lb. 50c; lb. \$1.50.**

THE BOTTOMLEY—This is without a doubt the best yet. We can safely say it will produce more and better fruit than any Cantaloupe on the market today. In fact, every grower of melons who has tried this sort will unhesitatingly say, "There is none better." The seed we offer is from the true stock, and must not be confounded with seeds sold at a less price by unscrupulous dealers. Grown by us under our own supervision, where it can be carefully watched, and in one of the best sections of the country for the growing of Cantaloupes, there is no reason why this should not rank as the best on the market. In quality it has no rival. From 7 to 8 days later than the Knight. The vine makes a very heavy growth, which makes it blight-resisting. Fruit very uniform in size, averaging about 7 inches in length from stem to blossom end. Very thick-meated, of a greenish color. Small seed cavity; thin rind, beautifully netted. Slightly pointed at the stem end and rather blunted at the blossom end. A prominent commission merchant who sells tons of melons each year says: "It is the best that comes to the Baltimore wholesale market, and never fails to command a higher price than any other variety." For shipping it is unexcelled. **Pkts. 5c and 10c; oz. 20c; ¼ lb. 75c; lb. \$2.50.**

OSAGE, or MILLER'S CREAM—A medium to large-sized melon of excellent quality. Vines vigorous and productive. The fruits are oval, dark green in color, slightly ribbed and partly covered with shallow gray netting. The flesh is salmon-colored, thick, fine-grained and highly flavored. **Pkts. 5c and 10c; oz. 15c; ¼ lb. 50c; lb. \$1.50.**

EMERALD GEM—Among the standard varieties this has long been a leader. The flesh, which is thicker than any other melon of the same shape, is a rich salmon

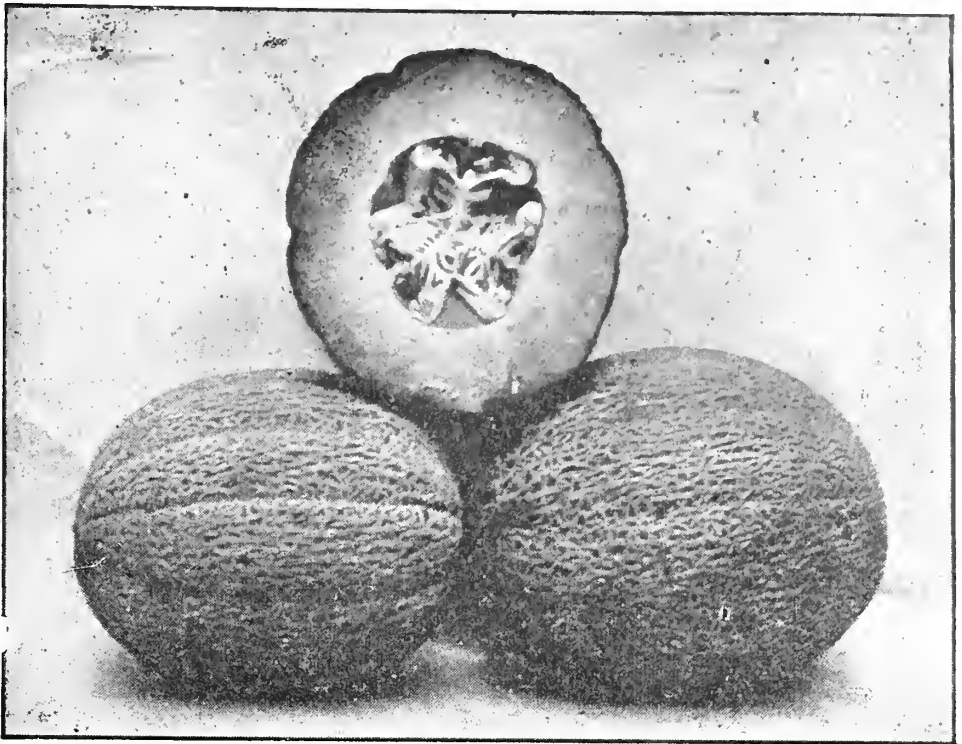

Extra-Early Knight Cantaloupe

shade, and ripens extremely close to the rind. It is exceedingly sweet and one of the melons when you once eat of it you will remember it for a long while. **Pkts. 5c and 10c; oz. 15c; ¼ lb. 40c; lb. \$1.25.**

NETTED GEM—Grows remarkably uniform; thick-meated, flesh light green in color and of fine, luscious flavor; skin green, regularly ribbed and thickly netted; very productive and extra early in ripening; will keep for nearly a week after picking, and is especially suited for shipping in baskets or crates. **Pkts. 5c and 10c; oz. 15c; ¼ lb. 40c; lb. \$1.25.**

BALTIMORE NUTMEG—Fruit uniform in size and of attractive appearance. Green flesh and very sweet flavor. An excellent shipper. **Pkts. 5c and 10c; oz. 15c; ¼ lb. 40c; lb. \$1.25.**

EARLY HACKENSACK—It is well netted, deeply ribbed, making it ideal for cutting in slices on account of its large size. The flesh is light green, very thick and ripens well to the rind. The shape is even more flat than the Emerald Gem. **Pkts. 5c and 10c; oz. 15c; ¼ lb. 40c; lb. \$1.25.**

JENNY LIND—A small, flat, very early sort, heavily netted and ribbed with green flesh, an altogether good variety to plant with others, using this for the first picking. **Pkts. 5c and 10c; oz. 15c; ¼ lb. 40c; lb. \$1.25.**

PAUL ROSE—The fruits are nearly round, ribbed and heavily netted. The flesh is thick, of rich deep orange color, and ripens close to the rind, with small seed cavity. It is an excellent shipper. **Pkts. 5c and 10c; oz. 15c; ¼ lb. 40c; lb. \$1.25.**

ONION SEEDS

(German, Zwibbel; French Oignon; Spanish, Cebolla)

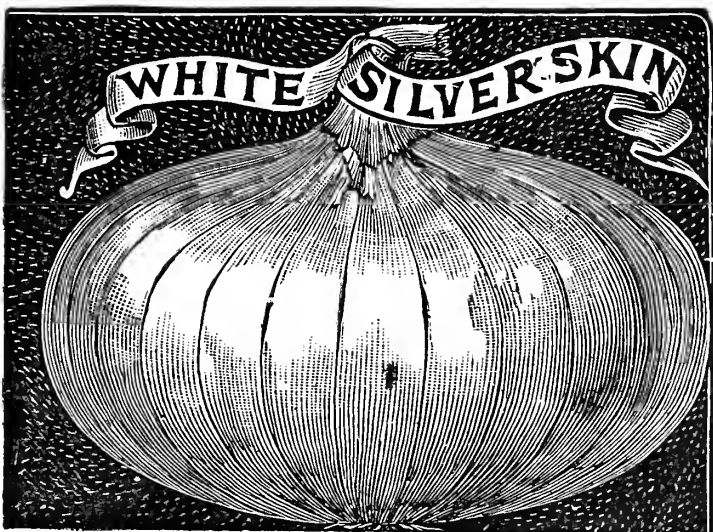

White Silverskin

CULTURE—A strong, deep, rich and loamy soil is most suitable for this crop. Muck beds well drained to the depth of 2 feet give large yields. A black sandy loam is also excellent. The ground should be heavily dressed with well-rotted manure and plowed a moderate depth, taking a narrow furrow in order to more thoroughly mix the manure with the soil; if possible, the plowing should be done in the Fall. As early in the Spring as the ground is in working order harrow it thoroughly and make as fine and level as possible; sow thinly in drills ¼ inch deep and 14 inches apart.

WHITE SILVERSKIN—This is the most popular of all white Onions. The skin and flesh is a silvery white, mild flavor and flat shape. **Pkts. 5c and 10c; oz. 25c; ¼ lb. 60c; lb. \$2.00.**

WHITE PEARL—A very popular variety for medium-early crop. Very mild in flavor; color pearly white; very large, especially if planted on good rich soil. A splendid variety for the market gardeners. Good keeping qualities and heavy yielder. **Pkts. 5c and 10c; oz. 25c; ¼ lb. 60c; lb. \$2.00.**

PRIZETAKER—Flavor very mild and delicate. A very handsome Onion, of the largest size, and nearly globular in form. Skin is yellowish-brown; flesh white. If started very early in hotbeds it will produce a mammoth Onion the first season. **Pkts. 5c and 10c; oz. 25c; ¼ lb. 75c; lb. \$2.50.**

Be Sure To Plant The "Wisdom" Tomato (See Page 23)

YELLOW GLOBE DANVERS—One of the most popular sorts for home or market gardens. Handsome, round, yellow Onion. A splendid keeper, and one that yields well. Can highly recommend this for growing either large or small Onions. **Pkts. 5c and 10c; oz. 20c; ¼ lb. 60c; lb. \$2.00.**

LARGE RED WETHERSFIELD—This is a well-known sort. A good yielder and an excellent keeper, and where red Onions are wanted there is none better. **Pkts. 5c and 10c; oz. 20c; ¼ lb. 60c; lb. \$2.00.**

LARGE YELLOW STRASBURG—A good keeping sort. Very popular with those who grow Onions Set for market. **Pkts. 5c and 10c; oz. 15c; ¼ lb. 40c; lb. \$1.50.**

AUSTRALIAN BROWN—Is of medium size, wonderfully hard and solid, and most attractive for market, both as to form and appearance. The color of the skin is a clear amber-brown. So widely contrasted from any other Onion is this color that it will be noticed on the market, and when once bought purchasers will be likely to return and call again for "those beautiful brown Onions." **Pkts. 5c and 10c; oz. 20c; ¼ lb. 50c; lb. \$1.50.**

YELLOW FLAT DANVERS—**Pkts. 5c and 10c; oz. 15c; ¼ lb. 40c; lb. \$1.50.**

ONION SETS

To raise Onion Sets from seed, use good ground, prepared as for large Onions, and sow the seed very thick in broad drills, using 40 to 60 pounds per acre. If the seed is sown thin, the bulbs will not only be too large for sets, but will not be of the right shape, and if sown thick on poor land they will be necky and bottle-shaped. Onion seed sown for Sets may be sown somewhat later than if a crop of large bulb is desired.

WHITE SILVERSKIN—Qt. 40c.

YELLOW DANVERS—Qt. 30c.

Owing to market changes, we cannot quote prices on larger quantities except on application.

PARSLEY

(German, Petersilie; French, Persil;
Spanish, Perejil)

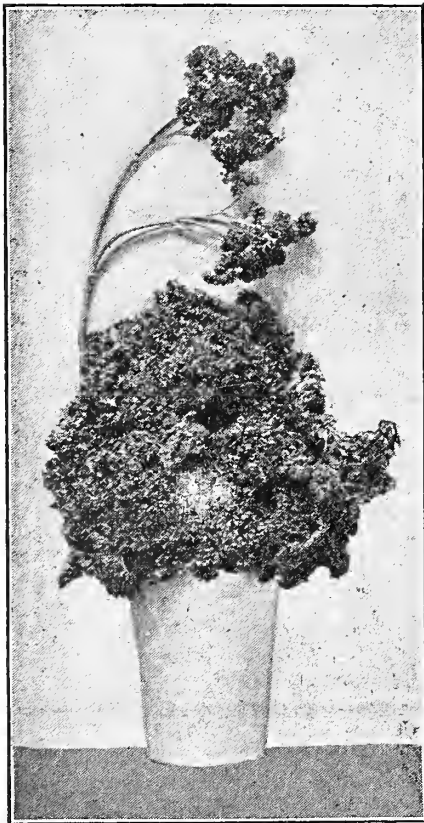

Parsley succeeds best on rich, mellow soil. The seed is very slow in germinating, and should be sown as early as possible in the Spring, in drills 1 to 2 feet apart, covering not more than ¼ inch with fine soil, firmly pressed down. When plants are well up thin to 4 inches apart in the row. When the plants of the curled varieties are about 3 inches high cut off all the leaves. The plant will then start a new growth of leaves, which will be brighter and better curled. Every cutting will result in improvement.

DWARF CURLED—Handsomely crimped and curled; bright green color. **Pkts. 5c and 10c; oz. 15c; ¼ lb. 30c; lb. \$1.00.**

MOSS CURLED—Vigorous, compact-growing variety. Excellent for garnishing and flavoring. **Pkts. 5c and 10c; oz. 15c; ¼ lb. 30c; lb. \$1.00.**

Market Gardeners, Institutions or Planters wishing Seeds in large quantities are requested to mail us a list of their wants. A letter of inquiry may save you dollars, if you are needing considerable quantities of seed.

OKRA, or GUMBO

(German, Essbarer; Eibisch; French, Gombaud,
Spanish, Quimbombo)

Cultivated for its young seed pods, which are used in soups, stews, catsups, etc. After danger of frost is past, the ground being warm and in good condition, plant in rows about 2½ feet apart, covering with about an inch of fine soil, firmly pressed down. When about 3 inches high thin to about 1 foot apart in the row.

DWARF PROLIFIC—The pods are from 4 to 5 inches long and are very tender, slim and of a beautiful deep green color. **Pkt. 5c; oz. 10c; ¼ lb. 25c; lb. 65c.**

WHITE VELVET—Pods free from ridges and very tender. **Pkt. 5c; oz. 10c; ¼ lb. 25c; lb. 65c.**

MUSHROOM SPAWN

CULTURE—Mushrooms may be grown in cellars, under benches in greenhouses or in sheds wherever the temperature of 50 degrees can be kept up during the

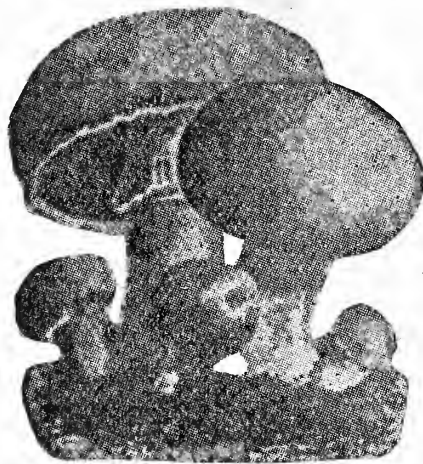

Winter. The beds should be made from November to February, according to the time the Mushrooms are wanted, and it requires about two months for them to begin bearing. Secure fresh horse dung, free from straw and litter, and mix an equal bulk of loam from an old pasture with it. Keep this under cover taking care to turn it every day to prevent it from heating, until the pile is large enough to make a bed of the required size. Three or 4 feet wide, 8 inches deep

and any length desired, are the proper proportions for a bed, but this may be varied. Prepare the mixture of loam and manure, making the bed in layers and pounding down each with the back of a spade. Leave this to heat through for a few days and as soon as the heat subsides to 90 degrees make holes in the bed about a foot apart each way, into which put pieces of spawn 2 or 3 inches in diameter; fill up the hole with compost, and at the expiration of a week or 10 days the spawn will have thoroughly diffused itself through the bed. Spread layer of soil over the heap to the depth of 2 inches, and cover with 3 or 4 inches of hay, straw or litter. Examine bed often to see that it does not get dry. Take special care, however, when water is given that it be at a temperature of 100. One brick to a bed 6 feet square.

Much interest is being shown in the growing of Mushrooms, and many persons will consider going in the business. Those who have this in mind should read either or both of the books offered below. These books were written by men who have made a business of growing the crop for market, and the information given will be extremely valuable, as they tell the whole story from the making of bed to marketing the crop.

BEST ENGLISH MILLTRACK SPAWN—Brick, 1¼ lbs., 25c; 10 lbs. \$2.50.

IMPORTANT BOOKS ON MUSHROOM CULTURE:

"Mushrooms: Edible, Poisonous, Etc.," by Atkinson.—The best book for the amateur; finely illustrated. **Price, postpaid, \$3.00.**

"Mushrooms: How to Grow," by Wm. Falconer.—**Price, postpaid, \$1.00.**

NASTURTIUMS

The Nasturtium is one of the popular flowers of the present time, and is continually growing in favor for the table. The leaves are used for salad and the seed for pickles.

TALL—**Pkts. 5c and 10c; oz. 15c; ¼ lb. 30c; lb. \$1.00.**

DWARF—**Pkts. 5c and 10c; oz. 15c; ¼ lb. 30c; lb. \$1.00.**

PEAS

(German, Erbsen; French, Pois; Spanish, Chicaros o Ginsantes)

CULTURE—For early Peas the soil should be light and warm, but for general crop a moderately heavy soil is better. Fresh manure and very rich or wet, mucky soil should be avoided, as they cause a rank growth of vine at the cost of the quality of the Peas; such soil is often the cause of early sorts maturing unevenly. Sow as early as possible a few of some early variety on warm, quick soil, prepared the fall before. The general crop can be delayed until later, but we have met with better success from sowing all the varieties comparatively early, depending for succession upon selecting sorts that follow each other in maturity. The Peas will give quicker returns if covered only 1 inch deep, and where earliness is most important they may be treated in that way. Larger pods and more of them will be produced if the seed be planted in trenches 3 to 6 inches deep and covered with only 1 or 2 inches of soil. When the plants are 5 or 6 inches high fill the trench level with the surface; this will secure deep rooting, prevent mildew and prolong the bearing season. If the Peas be covered to the full depth at first, or if water be allowed to stand in trenches, they will not germinate or grow well.

EXTRA-EARLY VARIETIES

LARGE-PODDED ALASKA—Vines 2½ feet. The pods are well shaped and well filled, containing 6 to 8 Peas of a beautiful green color, both Peas and pods retaining their fresh green color longer after being picked than other kinds, this being a point of particular value when they are grown for shipping purposes. We strongly recommend

this Pea to our customers, believing it will bring them increased profits from their Pea crops on account of its extreme earliness, well-filled pods, great productiveness and especial value as a market sort. **Pkt. 5c; pt. 20c; qt. 35c; pk. \$2.50; bu. \$9.00.**

ALASKA—Vines 2½ ft. Seed small, smooth and bluish green in color. Unequaled evenness in growth of vine and early maturity of pods, which are filled with medium-sized, bright green Peas of good flavor. **Pkt. 5c; pt. 20c; qt. 35c; pk. \$2.25; bu. \$8.00.**

FIRST AND BEST—Height 2½ feet. Very early and prolific. White seeded. **Pkt. 5c; pt. 20c; qt. 35c; pk. \$2.50; bu. \$9.00.**

DEXTER—Height 2½ feet. Early and very prolific. **Pkt. 5c; pt. 20c; qt. 35c; pk. \$2.50; bu. \$9.00.**

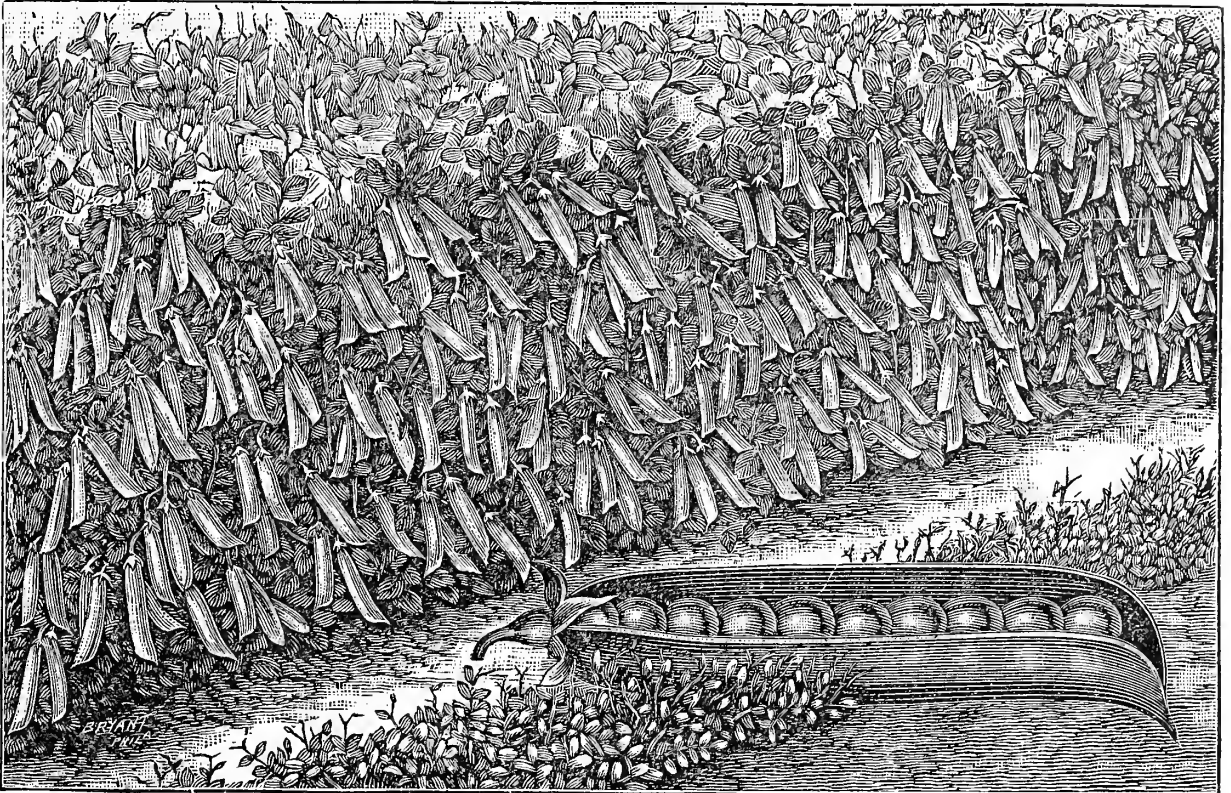

Prolific Early Market, or New Later

BOUNTIFUL—Of recent introduction. Early and very prolific; vines of even growth and bearing any number of well-filled pods, which are of a light green color, containing 6 to 8 Peas to the pod. **Pkt. 5c; pt. 25c; qt. 40c; pk. \$2.75; bu. \$10.00.**

PEDIGREE EXTRA EARLY—Introduced several years ago; has steadily increased in favor until now the truckers all want it. Early as Alaska; large pods, white seeded, very prolific. All mature at one time and can be gathered in one picking. **Pkt. 5c; pt. 20c; qt. 35c; pk. \$2.50; bu. \$9.00.**

PROLIFIC EARLY MARKET, or NEW LATER—The new Pea, just recently introduced, has proven to be the finest, largest and most prolific extra-early variety on the market. It is larger than the Alaska, a few days later and more prolific than any of the other sorts. Will always command a higher price in the markets because of its handsome and showy pods. It is just the Pea for the trucker and also the home garden. **Pkt. 5c; pt. 20c; qt. 35c; pk. \$2.50; bu. \$9.00.**

RURAL NEW YORKER—Height 2½ feet. Matures among the earliest. **Pkt. 5c; pt. 20c; qt. 35c; pk. \$2.50; bu. \$9.00.**

LARGE-PODDED SUGAR VARIETIES

THOMAS LAXTON—Closely resembling Gradus in habit, rapidity of growth, earliness of foliage; 26 to 30 inches high, and much hardier in every respect than the Gradus. Pods 4 to 4½ inches long, round and well filled. Ready to pick 52 days from planting. **Pkts. 5c and 10c; qt. 40c; pk. \$3.00; bu. \$11.00.**

AMERICAN WONDER—Vigorous, productive vines, with a luxuriant foliage, producing the leaves on one side of the stalk, and growing from 9 to 12 inches high. On account of its dwarf habit of growth it is very desirable for private garden use. Pods are light-colored, straight, round, about 2½ inches long and blunt at the end. Fit for picking 55 days from planting. Seed is wrinkled green, medium in size and square at the ends. **Pkts. 5c and 10c; pt. 25c; qt. 40c; pk. \$3.00; bu. \$11.00.**

BLUE PETER, or BLUE TOM THUMB—One of the earliest and hardiest of the dwarf varieties; blue seed, dark green pods; large Peas of excellent quality; much superior to the White Tom Thumb. **Pkts. 5c and 10c; pt. 25c; qt. 40c; pk. \$3.00; bu. \$11.00.**

NOTT'S EXCELSIOR—Resembling Gems in habit, but more dwarf and uniform in growth. Height 12 to 17 inches, with rather light foliage. Pods are light in color, round, about 2½ inches long, blunt at the ends. Fit for picking 56 days from planting. Seed green, wrinkled, medium in size and square at the ends. **Pkts. 5c and 10c; pt. 25c; qt. 40c; pk. \$3.00; bu. \$11.00.**

GRADUS, or PROSPERITY—A large, wrinkled, early Pea, with a pod nearly as long as the Telephone; tender and of good quality and flavor. Very quick to germinate and mature with the other sorts. This Pea will not stand adverse conditions, however, as well as some of the other sorts, and seed must be planted after all danger of frost has passed. **Pkts. 5c and 10c; pt. 25c; qt. 40c; pk. \$3.00; bu. \$11.00.**

PREMIUM GEMS—Strong and vigorous in growth. Height about 15 inches; dark foliage, bearing pods on both sides of the stalk, beginning near the ground. Pods light in color and blunt at the ends. Seed is green, wrinkled and medium in size. **Pkts. 5c and 10c; pt. 25c; qt. 40c; pk. \$3.00; bu. \$11.00.**

Our Seeds are Best by Test

LONG ISLAND MAMMOTH—Very popular with market gardeners who want a large, handsome pod of a dark green color. **Pkts. 5c and 10c; pt. 25c; qt. 40c; pk. \$3.00; bu. \$11.00.**

DWARF TELEPHONE—Vines 18 to 26 inches high, with rather coarse foliage; medium light green, bearing pods broad, straight and about 4 inches long. Pale green in color and well filled with peas of excellent flavor. Ready for picking from 62 to 65 days from planting. Seed pale green, large, much wrinkled. **Pkts. 5c and 10c; pt. 25c; qt. 40c; pk. \$3.00; bu. \$11.00.**

SUTTON'S PIONEER—One of the latest achieve-

ments in the perfection of early Peas, and we cannot speak too highly of it. Sutton's Pioneer was introduced to the gardening public several years ago, and since then the demand has grown far ahead of the supply. It is a first-early sort and very prolific. One gardener says: "I never before grew such Peas; the large, handsome pods were packed with plump, tender, rich-flavored peas." This variety presents a rich appearance while growing on account of the large number of pods on each vine. Vines reach a height of 2 feet, are very strong and do not need support unless the soil is very rich. **Pkts. 5c and 10c; pt. 25c; qt. 40c; pk. \$3.00; bu. \$11.00.**

MEDIUM-EARLY WRINKLED VARIETIES

ABUNDANCE—Vigorous in growth and productive, bearing pods in great abundance, although of medium size and of excellent quality. Very similar in every respect to Hornford's Market Garden, except that it is a few days later, being fit for picking 71 days from planting. Pods are dark green and blunt. Seed green, wrinkled and medium in size. **Pkts. 5c and 10c; pt. 25c; qt. 40c; pk. \$3.00; bu. \$11.00.**

STRATAGEM—A vigorous, hardy and luxuriant vine, bearing large pods, containing Peas of excellent quality. A heavy cropper, but it has a tendency to sport. Vines 20 inches. Foliage dark green. Pods 3½ inches long, straight, broad-pointed, gray-green in color. Fit for table use 56 days from planting. Seed very large, green, wrinkled. **Pkts. 5c and 10c; pt. 25c; qt. 40c; pk. \$3.00; bu. \$11.00.**

EVERBEARING—Vigorous and bracing in habit of growth. Height 2½ to 3 feet. Pods 2¾ to 3 inches long, broad, light-colored and blunt. Fit to pick 70 days from planting. Seed green, wrinkled and large in size. **Pkts. 5c and 10c; pt. 25c; qt. 40c; pk. \$3.00; bu. \$11.00.**

SHROPSHIRE HERO—Strong, vigorous vines, 42 inches in height. Pods 3 to 3½ inches long, blunt, light green in color. Fit for table use 68 to 73 days from planting. Seed large, green and wrinkled. **Pkts. 5c and 10c; pt. 25c; qt. 40c; pk. \$3.00; bu. \$11.00.**

ADVANCER—Vines upright and vigorous in growth, hardy and productive. Height 36 inches. Foliage dark green. Pods 2½ to 2¾ inches long, round, dark-colored and blunt. Fit for picking 61 days from planting. Seed green, wrinkled and medium in size. A very fine Pea for canners' use. **Pkts. 5c and 10c; pt. 25c; qt. 40c; pk. \$3.00; bu. \$11.00.**

HORSEFORD'S MARKET GARDEN—Strongly resembling Premium Gem in habit of growth, but about one-third taller, vines growing 26 to 30 inches long. Foliage dark green. Pods light-colored, straight, about 2½ inches long and blunt. Fit for picking 68 days from planting. Seed green, wrinkled and medium size. A very popular Pea with the canners and market gardeners on account of its excellent quality, being as sweet as Telephone and very much more tender. **Pkts. 5c and 10c; pt. 25c; qt. 40c; pk. \$3.00; bu. \$11.00.**

YORKSHIRE HERO—Hardy, productive and upright in growth, bearing near the top of the stalk broad, pointed pods with Peas of good quality. Foliage dark green, 23 to 28 inches in height. Pods 2½ to 3 inches long, blunt, light green in color. Fit to pick 68 to 73 days from planting. Seed large, green and wrinkled. **Pkts. 5c and 10c; pt. 25c; qt. 40c; pk. \$3.00; bu. \$11.00.**

MEDIUM-EARLY WRINKLED VARIETIES

HEROINE—A medium-early, green, wrinkled Pea. Pods deep green in color. Very prolific. Height 2 to 2½ feet. An excellent Pea for the home garden. **Pkts. 5c and 10c; pt. 25c; qt. 40c; pk. \$3.00; bu. \$11.00.**

CHAMPION OF ENGLAND—Strong and vigorous in growth, 42 to 50 inches in height. Foliage medium green. Pods 2½ to 3 inches long, blunt, medium dark green in color. Fit to pick 68 to 73 days from planting. Seed large, green and very much wrinkled. **Pkts. 5c and 10c; pt. 25c; qt. 40c; pk. \$3.00; bu. \$11.00.**

FRENCH CANNER—Height 3½ feet; very prolific, bearing an abundance of long pods. Extensively planted by the truckers for canning. Seed white and small. **Pkt. 5c; pt. 20c; qt. 35c; pk. \$2.75; bu. \$8.00.**

IMPROVED SUGAR MARROWFAT—The truckers' favorite. Late in maturing and a tremendous yielder. Pods well filled with Peas of a very sweet flavor. **Pkt. 5c; pt. 20c; qt. 35c; pk. \$2.75; bu. \$8.00.**

PRIDE OF THE MARKET—Of fine growth and general appearance, both vine and pod, and closely resembles the Stratagem, except that the vine is not quite so long and the pods are deeper green in color. The vine is 20 inches high. Foliage dark green color. Pods are 3½ inches long, broad and dark in color. Fit for table use 61 days from planting. Seed blue, slightly dented and large. **Pkts. 5c and 10c; pt. 25c; qt. 40c; pk. \$3.00; bu. \$11.00.**

TELEPHONE—Vines and leaves large and coarse. Foliage light green in color. Height 40 to 50 inches. Pods 4½ inches long, broad, pointed and medium in color. Fit to pick 62 to 65 days from planting. Seed large, green and wrinkled. **Pkts. 5c and 10c; pt. 25c; qt. 40c; pk. \$3.00; bu. \$11.00.**

LAXTONIAN—Vine 1½ feet in height, with dark green foliage. Large, curved, dark green pods, pointed at the ends. Seed green, wrinkled, large-sized. **Pkts. 5c and 10c; pt. 25c; qt. 40c; pk. \$3.00; bu. \$11.00.**

TELEGRAPH—Closely resembling Telephone in all respects, except that the pods are a deeper shade of green and the Peas are of only fair quality, although the pods are of very fine appearance. Pods 4 to 4½ inches long, medium dark green, pointed. Fit to pick 65 days from planting. Seed large, blue and round, dented. **Pkts. 5c and 10c; pt. 25c; qt. 40c; pk. \$3.00; bu. \$11.00.**

LITTLE MARVEL—Height of vine 18 inches, with dark green foliage. Small, blunt, dark green pods. Fit for table use 53 to 55 days from planting. Seed blue-green, small-sized and wrinkled. **Pkts. 5c and 10c; pt. 25c; qt. 40c; pk. \$3.00; bu. \$11.00.**

WHITE MARROWFAT—Vines hardy, strong, vigorous and bearing broad, thick, leathery pods near the top of the vine, and containing Peas of a poor quality. Height 45 to 50 inches; foliage light green in color; pods 3 inches long, blunt and light green. Ready to pick 69 days from planting. Seed large, smooth, white. **Pkt. 5c; pt. 20c; qt. 35c; pk. \$2.50; bu. \$8.00.**

PRINCE EDWARD—This variety produces enormous pods 7 inches long and upwards, containing from 11 to 13 large dark green Peas and are mostly produced in pairs. This makes them much less tedious to pick. The plant is of strong growing habit, requiring stakes, but produces enormous crops. The pods are of unusually attractive appearance when placed on market, and are always saleable. We take great pleasure in recommending this new variety to our customers, as it is one of the most excellent quality and comes in late, after other varieties are too old. **Pkts. 5c and 10c; pt. 25c; qt. 40c; pk. \$3.00; bu. \$11.00.**

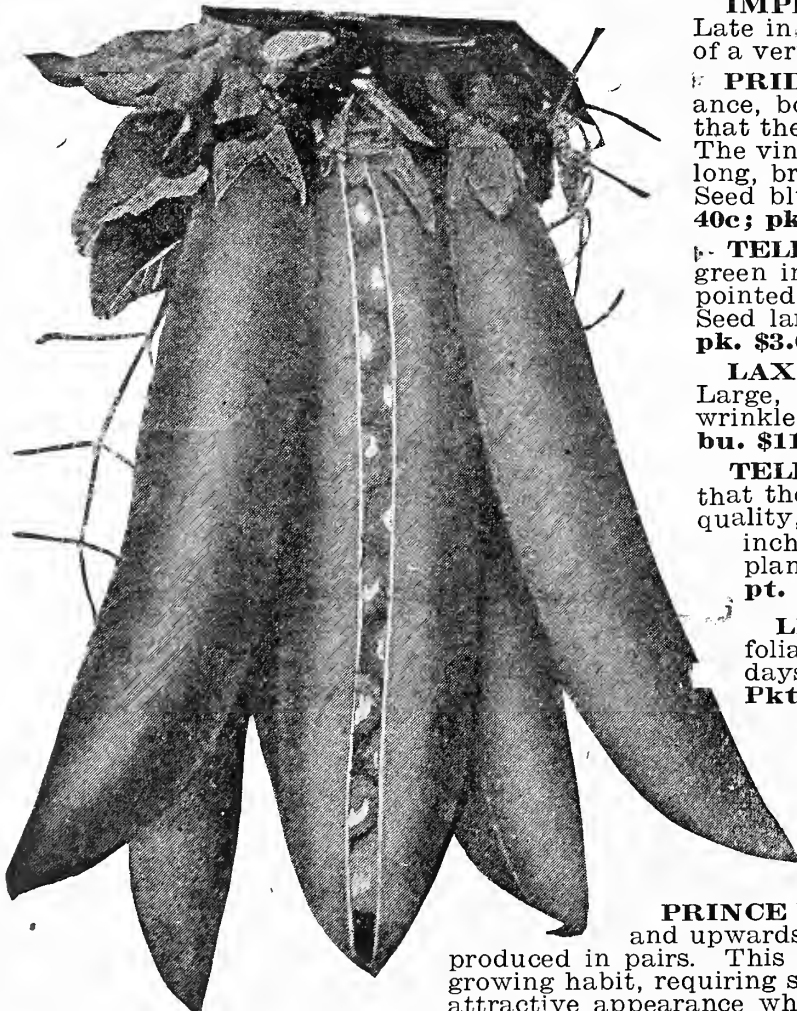

Pride of the Market Peas
excellent quality and comes in late, after other varieties are too old. **Pkts. 5c and 10c; pt. 25c; qt. 40c; pk. \$3.00; bu. \$11.00.**

EDIBLE-PODDED PEAS

MELTING SUGAR—One of the best varieties; a favorite. **Pkts. 5c and 10c; ¼ lb. 50c.**

PEAS—Sweet Flowering

To a greater extent than any other ornamental flower, have been improved in form and color, until now no garden is complete without them, as no flowers can be so cheaply, successfully and profusely grown, and no flowers provide more desirable table decorations, because of their rick and endless variety of high coloring and delicate tints. See list of Flower Seeds.



PARSNIP

(German, Pastinake;
French, Panais;
Spanish, Chirivia)

The value of the Parsnip as a culinary vegetable is well known, but is not generally appreciated at its full value for stock feeding. On favorable soil it yields an immense crop of roots, more nutritious than turnips and very valuable for dairy stock.

CULTURE—Parsnips are usually grown on deep, rich, sandy soil, but will make good roots on any soil which is deep, mellow and moderately rich. Fresh manure is apt to make the roots coarse and ill-shaped. As the seed is sometimes slow and uneven in growth, it should be sown as early as possible in drills 2½ feet apart; cover ½ inch deep and press the soil firmly over the seed. Give frequent cultivation, and thin the plants to 6 inches apart in the row.

HOLLOW CROWN, or GUERNSEY—An excellent variety for the table. Roots long, with smooth white skin, uniform in shape, tender and of the best quality. The variety is easily distinguished by the leaves growing from the depression on top or crown of the root. **Pkt. 5c; oz. 10c; ¼ lb. 25c; lb. 75c.**

PEANUTS

NEW MAMMOTH BUSH PEANUT—This Peanut does exceedingly well in the North, making compact bushes 18 inches high, with heavy, erect stalks and large leaves. They are good producers, and do best on light sandy soil. Easily grown and always sure to make a good crop. **Pt. 15c; qt. 30c.**

EARLY SWEET PEANUT—Let the children grow some Peanuts. The Early Sweet is very easy to raise. It stands the heat and drought like a salamander, and is so early it ripens in the Northern States and Canada, while its quality is of the very best, the nuts being exceedingly sweet and rich when roasted. Any light, sandy or loose soil suits them. **Pt. 15c; qt. 30c.**

PEPPER

(German, Pfeffer; French, Piment;
Spanish, Pimiento)

CULTURE—Peppers are most largely used for seasoning meat and vegetable dishes, also for making chow-chow and Chili sauce. The culture is the same as for Eggplant and the plants need quite as much heat to perfect them. Sow seed early in hotbed, or about middle of Spring in open seed bed, the soil being light and warm. When 3 inches high transplant in rows about 2½ feet apart and 2 feet apart in the row. Cultivate and keep free from weeds. Guano, hen dung or any other bird manure hoed into the surface soil when the plants are about 6 inches high will undoubtedly increase the product.

LARGE BELL, or BULL NOSE—Our stock of this well-known variety, sometimes called Sweet Mountain, is very superior. Plant vigorous, about 2 feet high, compact and very productive, ripening its crop uniformly and early. The fruits are large, with thick, mild flesh, of excellent quality for use in salads and mangoes or stuffed peppers. The color is deep green when fruit is young, bright crimson when ripe. **Pkts. 5c and 10c; oz. 40c; ¼ lb. \$1.50; lb. \$5.00.**

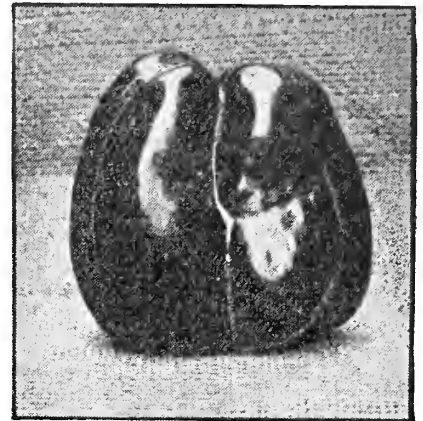

Bell, or Bull Nose

RUBY KING—An improved American variety, very large and attractive. The plant is about 2½ feet high, vigorous, compact and productive. The fruits are often 4 to 4½ inches long, and of deep green color when young, bright red when ripe. The flesh is thick and milk-flavored. One of the best varieties for mangoes or stuffed peppers. **Pkts. 5c and 10c; oz. 40c; ¼ lb. \$1.50; lb. \$5.00.**

NEW CHINESE GIANT PEPPER—The fruits of this variety are of monstrous size, even when put alongside such a large kind as Ruby King. The shape is more blocky than Ruby King, being almost square, or about the same diameter both ways. Color brilliant glossy scarlet. It is so immensely productive that frequently a half-dozen peppers will touch one another. The habit of growth is strong and stocky, about 18 to 24 inches high. Usually 3 or 4 fruits are set first near the base, and while these are ripening a second setting is growing higher up. Flesh is thick and meaty and entirely free from any fiery flavor. **Pkts. 5c and 10c; oz. 40c; ¼ lb. \$1.50; lb. \$5.00.**

RED CHERRY—A second-early sort. Plant tall, bearing a profusion of round, bright red fruits, which are very pungent when ripe. A very ornamental plant when in fruit. **Pkts. 5c and 10c; oz. 30c; ¼ lb. \$1.25; lb. \$4.50.**

RED CHILI—A late variety. Pods bright, rich red, about 2 inches long, ⅜ to ½ inch in diameter at the base, tapering to a sharp point, and exceedingly pungent when ripe. **Pkts. 5c and 10c; oz. 30c; ¼ lb. \$1.25; lb. \$4.50.**

LONG RED CAYENNE—A well-known medium-early variety, having a slender, twisted and pointed pod about 4 inches long; color deep green when fruit is young, bright red when ripe. **Pkts. 5c and 10c; oz. 40c; ¼ lb. \$1.25.**

MARKET GARDENERS, INSTITUTIONS OR PLANTERS WISHING SEEDS IN LARGE QUANTITIES ARE REQUESTED TO MAIL US A LIST OF THEIR WANTS. A LETTER OF INQUIRY MAY SAVE YOU DOLLARS, IF YOU ARE NEEDING CONSIDERABLE QUANTITIES OF SEED. :: :: ::

PUMPKIN

(German, Grosse-Kurbis; French, Potiron; Spanish, Calabazo)

CULTURE—Pumpkins are not so particular in regard to soil as Melons or Cucumbers, but are cultivated much the same. Plant seed about 10 feet apart, in hills, dropping about 10 seed to a hill. When plants are well started, thin to 3 plants to each hill. To plant in corn place seed about every third or fourth hill after the last working.

MARYLAND SWEET POTATO—This is without doubt the best for table use, resembling somewhat the Cushaw, but much prettier in color. A handsome green and white striped. Flesh yellow, solid, fine-grained and a delicious flavor. **Pkt. 5c; oz. 10c; ¼ lb. 25c; lb. 75c.**

CUSHAW, or WINTER CROOKNECK—An old standard variety, which is very popular. It is also used for feeding stock. Long yellow crookneck, fine-grained, yellow flesh, very solid. **Pkt. 5c; oz. 10c; ¼ lb. 25c; lb. 75c.**

TENNESSEE SWEET POTATO—One of the best sorts for pies. Pear-shaped, medium size, flesh and skin creamy white, fine-grained, sweet, and excellent keeper. **Pkt. 5c; oz. 10c; ¼ lb. 25c; lb. 75c.**

WINTER LUXURY—This is one of the best pie Pumpkins in existence, and its Winter-keeping qualities are almost unequalled. Is slightly oval in shape and of medium size. Evenly and finely netted, and is a yellowish russet color. The flesh is very tender, sweet and rich golden in color. A great producer. **Pkt. 5c; oz. 10c; ¼ lb. 25c; lb. 75c.**

LARGE CHEESE—Skin rich salmon color, fine grain, dry and sweet. **Pkt. 5c; oz. 10c; ¼ lb. 25c; lb. 75c.**

CONNECTICUT FIELD PUMPKIN—Usually planted for feeding stock. So well known that it needs no description. **Pkt. 5c; oz. 10c; ¼ lb. 25c; lb. 75c.**

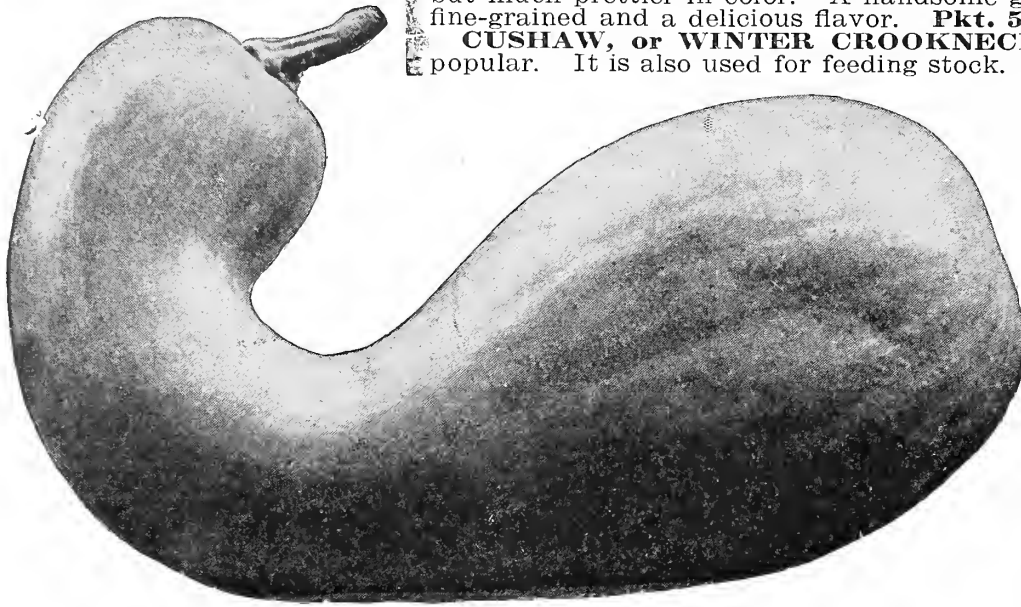

Maryland Sweet Potato Pumpkin

RADISH

(German, Radischen; French, Radis, Rave, Petite Rave; Spanish, Rabana)

CULTURE—For forcing sow in hotbeds or under glass in rich sandy soil, made perfectly level. Scatter evenly over the surface from 50 to 100 seeds to the square foot and cover with ½ inch of soil sifted on. Careful watering to keep soil moist, even, moderate temperature, and good ventilation are required for rapid and best root development. If the bed is a good one, the whole crop can be marketed in 21 to 40 days after planting. For open-ground culture sow on rich sandy soil as soon in the Spring as it is fit to work, in drills 12 to 18 inches apart, and thin out the plants to prevent crowding. A good dressing of nitrate of soda will greatly stimulate growth and insure tender, brittle roots. Successional sowing from 1 week to 10 days apart will keep up a supply. After the hot weather of Summer begins, it is better to sow the Summer and Winter varieties, as they do not become tough and stringy not pithy so quickly as the earlier sorts. One ounce of seed to 100 feet of drill.

EARLY LONG SCARLET SHORT TOP—This is a standard, most excellent sort either for the home garden or the market. Tops short and comparatively small. Roots smooth, slender, uniform in shape and a very attractive bright red in color. They continue crisp until fully matured, when they are about 6 inches long. **Pkt. 5c; oz. 10c; ¼ lb. 20c; lb. 60c.**

CINCINNATI MARKET—Roots very slender, of a deep red color and longer than the Long Scarlet, often becoming 7 inches long. **Pkt. 5c; oz. 10c; ¼ lb. 20c; lb. 60c.**

WHITE-TIPPED SCARLET—A good forcing variety; small size and very attractive, being a handsome bright scarlet with white tip. Very early and of good quality. **Pkt. 5c; oz. 10c; ¼ lb. 20c; lb. 60c.**

PRUSSIAN GLOBE—The earliest forcing Radish; roots small and round; deep scarlet with white flesh. Very tender. **Pkt. 5c; oz. 10c; ¼ lb. 20c; lb. 60c.**

FRENCH BREAKFAST—Very rapid grower; mild and tender; beautiful scarlet color, white-tipped; oblong shape. **Pkt. 5c; oz. 10c; ¼ lb. 20c; lb. 60c.**

EARLY WHITE TURNIP—For forcing; very tender and crisp; turnip-shaped. Bunched with the Scarlet Globe, it makes a splendid contrast. **Pkt. 5c; oz. 10c; ¼ lb. 20c; lb. 60c.**

TRIUMPH—Beautiful and odd in color. The root is globe-shaped, having bright scarlet stripes on a white ground. Excellent for forcing. Short top, small leaves and matures very quickly. **Pkt. 5c; oz. 10c; ¼ lb. 20c; lb. 60c.**

ICICLE—A very attractive, pure white Radish; the earliest of the long white Summer sorts and of most excellent quality. The roots are somewhat shorter, with smaller tops than the long White Vienna, and matures a little earlier. One of the most desirable varieties for outdoor Summer planting. It is also adapted for forcing. **Pkt. 5c; oz. 10c; ¼ lb. 20c; lb. 60c.**

LONG WHITE VIENNA, or LADY FINGER—An early-maturing, attractive, long white Summer Radish of most excellent quality; tops medium size; roots pure white, slender, smooth and averaging about 7 inches long. **Pkt. 5c; oz. 10c; ¼ lb. 20c; lb. 60c.**

EARLY SCARLET GLOBE—(See cut.)—A desirable sort for hotbed forcing and outdoors; very early; flavor mild, crisp, juicy and tender; top small. Will stand heat without becoming pithy. One of the best selling and most attractive Radishes on account of its bright scarlet color and handsome shape. **Pkt. 5c; oz. 10c; ¼ lb. 20c; lb. 60c.**

LARGE WHITE SUMMER—This is one of the best white Radishes for Summer use. Very popular with the market gardeners, because of its beautiful appearance and ready sale and its well-known quality of being slow to run to seed. **Pkt. 5c; oz. 10c; ¼ lb. 20c; lb. 60c.**

MODEL WHITE BOX (Short Top)—of quick growth; roots round, pure white; tails very thin, leaves short; flavor excellent. Fine for forcing and open ground. **Pkt. 5c; oz. 10c; ¼ lb. 20c; lb. 60c.**



Early Scarlet Globe

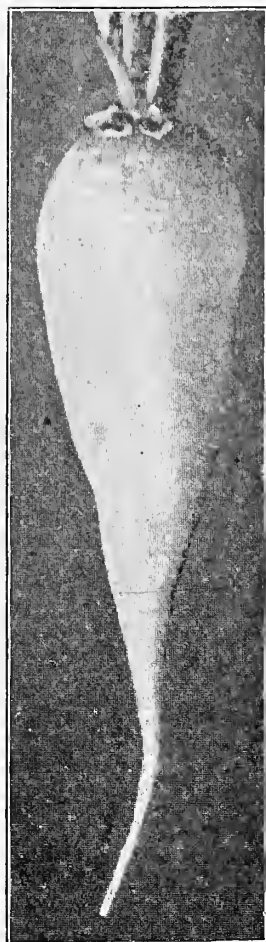

White Strasburg

EARLY WHITE OLIVE-SHAPED—Olive-shaped, terminating in a very slim tap root; tender and excellent in flavor. Pkt. 5c; oz. 10c; ¼ lb. 20c; lb. 60c.

GIANT STUTTGART—A Summer variety. Grows to an immense size; white flesh, very crisp and tender; of good flavor and a good keeper. Pkt. 5c; oz. 10c; ¼ lb. 20c; lb. 60c.

CHARTER—Very slow going to seed. Crisp and tender. A splendid variety for market gardeners. Pkt. 5c; oz. 10c; ¼ lb. 20c; lb. 60c.

GOLDEN GLOBE—This variety is of quick growth, affording crisp and tender Radishes even in the hottest climate, and is extensively grown in the South. Root uniformly globe-shaped, with skin golden yellow in color; about 2 inches long by 2¼ inches in diameter when matured. Pkt. 5c; oz. 10c; ¼ lb. 20c; lb. 60c.

WHITE STRASBURG—Even when comparatively small this variety is in good condition for use, and continues crisp until matured, when the roots are 4 to 6 inches long by 1½ to 2 inches in diameter. This is considered one of the best large white Summer sorts. The roots remain in condition for use much longer than the early varieties. Pkt. 5c; oz. 10c; ¼ lb. 20c; lb. 60c.

WHITE DELICACY—Among the earliest Spring varieties, resembling the White Strasburg; very tender, crisp, smooth and clean. Pkt. 5c; oz. 10c; ¼ lb. 20c; lb. 60c.

WINTER VARIETIES

WHITE CHINESE WINTER, or CELESTIAL—Roots long, cylindrical, with beautiful white skin and flesh; the whitest and usually the least pungent of the Winter varieties. Flesh compact and crisp. Pkt. 5c; oz. 10c; ¼ lb. 25c; lb. 75c.

CHINESE ROSE—Roots cylindrical or largest near the bottom, stump-rooted, blunt at both ends. Skin smooth, bright deep rose. Pkt. 5c; oz. 10c; ¼ lb. 25c; lb. 75c.

LARGE WHITE SPANISH—Long and tapering, and when full grown measuring 6 to 9 inches long. Skin white; flesh white. Pkt. 5c; oz. 10c; ¼ lb. 25c; lb. 75c.

ROUND BLACK SPANISH—Round, sometimes slightly top-shaped. Skin black; flesh white. Keeps well through the Winter. Pkt. 5c; oz. 10c; ¼ lb. 25c; lb. 75c.

ROUND WHITE SPANISH—A good Winter-keeping variety. Pkt. 5c; oz. 10c; ¼ lb. 25c; lb. 75c.

LONG BLACK SPANISH—One of the latest and hardest long Radishes, especially adapted for Winter use. Pkt. 5c; oz. 10c; ¼ lb. 25c; lb. 75c.

SPINACH

(German, Spinat; French, Espinard; Spanish, Espinaca)

Special Prices in Quantities.

CULTURE—For Summer use, sow early in Spring, in drills 8 to 10 inches apart, covering the seed 1 inch deep. Soil should be very rich, the richer the better. For early Spring use, sow in August and protect with a light covering of straw.

BLOOMSDALE CURLED SAVOY—A very early variety and one of the best to plant for early Spring use. Thick, glossy, dark green leaves, of medium size, pointed, but quite broad and crumpled and blistered; seed round. A rapid grower, but running to seed quickly in warm weather. Pkt. 5c; oz. 10c; ¼ lb. 15c; lb. 35c.

NEW ZEALAND—Unlike true Spinach in type and in that it thrives during hot weather and in any soil rich or poor. The tender shoots may be cut throughout the Summer. Pkts. 5c and 10c; oz. 20c; ¼ lb. 50c; lb. \$1.50.

LONG SEASON—A very dark green, crumpled variety, in general appearance similar to Savoy, but considerably larger and broader in leaf, less crumpled and very much longer standing. Pkt. 5c; oz. 10c; ¼ lb. 15c; lb. 35c.

VICTORIA—An excellent sort, forming a large, exceedingly thick, very dark green leaf, slightly crumpled in the center. Leaves unusually rounded or blunt. Remains in condition long after all the other sorts have gone to seed. Pkt. 5c; oz. 10c; ¼ lb. 15c; lb. 35c.

PRICKLY WINTER—Plant very large at maturity, with many medium-sized leaves; very vigorous and hardy. Leaves usually rounded at end, quite thick and uniformly dark green. Usually planted in the Fall. Seed prickly. Pkt. 5c; oz. 10c; ¼ lb. 15c; lb. 50c.

LONG STANDING—An improved round-seed strain of excellent quality. Will remain in condition much longer than other sorts. Leaves dark green, broad and thick. Pkt. 5c; oz. 10c; ¼ lb. 15c; lb. 35c.

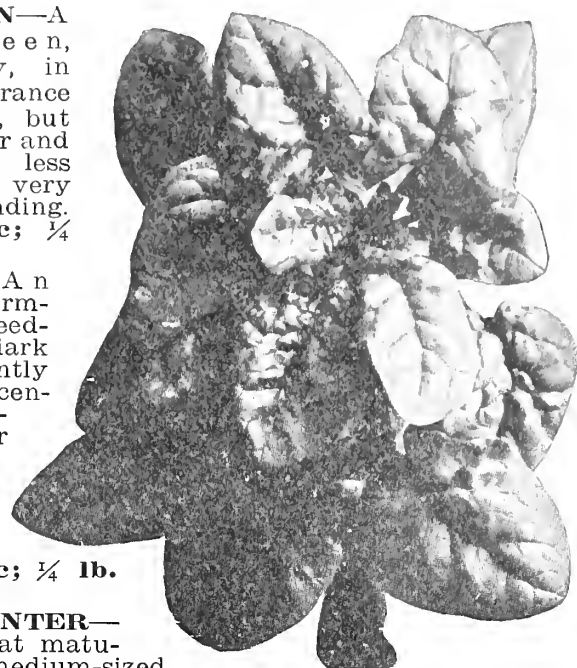

SALSIFY Better Known as Oyster Plant

(German, Hafer-Wurzel; French, Salsifis; Spanish, Ostian Vegetal)

CULTURE—Seed should be sown in early Spring, in light, rich soil, in drills 14 inches apart, and thin to 6 inches in the row. The roots are perfectly hardy, and many remain out all Winter.

MAMMOTH SANDWICH ISLAND—This variety is large and strong, growing with long, smooth, white, tapering roots, and is less liable to branch than the other sorts. Tops grassy. It is invaluable for market gardeners' use. Pkts. 5c and 10c; oz. 15c; ¼ lb. 50c; lb. \$1.50.

RHUBARB Also Known as Pie Plant

(German, Ehabarber; French, Rhubarb; Spanish, Ruibarbo)

Is the earliest Spring vegetable and is grown for its leaf stalks, which are extensively used for pies and sauce. One ounce of seed to 125 feet of drill.

SEED—Pkt. 5c; oz. 20c; ¼ lb. 60c.

ROOTS—Each, 10c; dozen \$1.00.

VEGETABLE ROOTS

	Per 100.	Per 1,000.
ASPARAGUS —		
Palmetto.....	\$1.00	\$6.50
Barr's Mammoth.....	1.00	6.50
Mammoth White.....	1.00	6.50
Conover's Colossal.....	1.00	6.50
ARTICHOLES —	Pk. 75c; bu. \$2.50.	
HORSE RADISH —	Doz. 25c; 100, \$2.00.	
RHUBARB —	Each, 10c; dozen, \$1.00.	

AROMATIC, MEDICINAL and POT HERBS

	Pkts.	Oz.
Anise.....	5c	15c
Balm.....	5c, 10c	30c
Borage.....	5c	10c
Basil.....	5c, 10c	15c
Caraway.....	5c	10c
Chervil.....	5c, 10c	25c
Chicory.....	5c	10c
Coriander.....	5c	10c
Dill.....	5c	10c
Fennel (Sweet).....	5c	10c
Lavender.....	5c	15c
Rosemary (Aromatic).....	5c	35c
Sage.....	5c	25c
Savory (Summer).....	5c	10c
Thyme.....	5c	25c

SQUASH

(German, Spiese-Kurbis; French, Courge;
Spanish, Calabaza)

CULTURE—One of the most nutritious and valuable of garden vegetables. The Summer varieties come to the table early in the season, while the Fall and Winter sorts can be had from August until the following Spring. The Winter varieties are very well adapted for stock feeding, and we heartily recommend them for that purpose.

Squash plants are very tender and sensitive to cold, and so planting must be delayed until settled warm weather. General methods of culture are same as for Cucumbers and Melons, but Squash is less particular as to soil. Summer varieties should be planted 4 to 6 feet apart each way, and Winter sorts 8 to 10. Three plants are sufficient for a hill. In gathering the Winter sorts care should be taken not to bruise or break the stem from the Squash, as the slightest injury will increase the liability to decay. Winter Squashes should be stored in a moderately warm, dry place and the temperature kept as even as possible. For those who desire very early Squashes seed can be planted in boxes and transplanted.

EARLY WHITE BUSH SCALLOP—This is the well-known very early, somewhat flattened, scalloped Bush Squash, of medium size. The color is creamy white with comparatively smooth surface. The vines are vigorous and very productive. This variety is also known as Patty Pan, or Cymbing. **Pkts. 5c and 10; oz. 15c; ¼ lb. 30c; lb. \$1.00.**

EARLY YELLOW BUSH SCALLOP—An early, flat scalloped-shaped variety; color yellow; flesh pale yellow and of very good flavor. **Pkts. 5c and 10c; oz. 15c; ¼ lb. 30c; lb. \$1.00.**

SUMMER CROOKNECK—An old standard sort, early and productive. Fruits, when fully grown, are about 1 foot long, with uniformly crooked neck and surface densely warted. Color yellow. **Pkts. 5c and 10c; oz. 15c; ¼ lb. 25c; lb. 90c.**



**Boston
Marrow
Squash**

BOSTON MARROW—A very productive Fall and Winter variety of medium to large size, oval shape, skin thin. Orange color; flesh fine-grained and of excellent flavor. **Pkt. 5c; oz. 10c; ¼ lb. 25c; lb. 70c.**

HUBBARD—One of the best of the Winter Squashes. Vines vigorous and very productive. Fruit heavy, moderately warted, with very hard shell. Skin a dark bronze-green. Flesh a bright orange-yellow, fine-grained, thick, dry and richly flavored. **Pkt. 5c; oz. 10c; ¼ lb. 25c; lb. 75c.**

MAMMOTH CHILI—The outer skin of this great Squash is a rich orange-yellow. The flesh is yellow and very thick, and the quality is good and nutritious. It is of the highest value as a stock food, far exceeding ordinary Pumpkin in this respect, and answering as well as root crops. It is a prolific variety, and a good Winter keeper. Has reached the great weight of 292 pounds. It is a typical sort to grow for exhibition at the fairs. **Pkt. 5c; oz. 10c; ¼ lb. 25c; lb. 75c.**

Market Gardeners, Institutions or Planters wishing seeds in large quantities are requested to mail us a list of their wants. A letter of inquiry may save you dollars, if you are needing considerable quantities of seed.

TURNIP

(German, Streckruebe; French, Navet;
Spanish, Nabo)

CULTURE—For Summer use sow early in Spring in light, rich soil, in drills 1½ feet apart, according to the size of the variety, and cover ½ inch deep, or sow broadcast, but in either case be sure to have the ground rich and freshly stirred. Thin early and keep free from weeds, so that the young plants will not be checked in growth. For Fall and Winter use sow the seed from middle of June to the first of August and in the manner given for Spring sowing. In the field Turnips are often sown broadcast at the rate of 1½ pounds to the acre.

PURPLE-TOP WHITE GLOBE—(See cut.)—This excellent table variety is globular in shape, of good size and very attractive in appearance. The roots are large, purple, or dark red above ground, white below. The flesh is fine-grained and tender. This sort keeps well for so early a variety and is one of the best for market use. **Pkt. 5c; oz. 10c; ¼ lb. 15c; lb. 40c.**

EXTRA-EARLY PURPLE-TOP MILAN—Very early, fine-grained white flesh. Flat and of good size. **Pkt. 5c; oz. 10c; ¼ lb. 15c; lb. 40c.**

PURPLE-TOP WHITE FLAT—This sort is very much similar to the Purple-Top White Globe in habit of growth, except it is flat rather than globular. **Pkt. 5c; oz. 10c; ¼ lb. 15c; lb. 40c.**

WHITE FLAT—Differs from Purple-Top only in color; fine-grained and of good quality. **Pkt. 5c; oz. 10c; ¼ lb. 15c; lb. 40c.**

COW HORN or LONG WHITE—This variety is clear white, except a little shade of green at the top of the root, which is long and carrot-like in form, slightly crooked and grows nearly half out of the ground. The flesh is fine-grained and well flavored, and for table use is in best condition when the roots are about 2 inches in diameter. **Pkt. 5c; oz. 10c; ¼ lb. 15c; lb. 30c.**

YELLOW or AMBER GLOBE—Very large, yellow-fleshed, fine-grained variety. Excellent for table use or feeding stock. **Pkt. 5c; oz. 10c; ¼ lb. 15c; lb. 40c.**

SEVEN - TOP—Cultivated extensively for the tops, which are used for greens. In many sections it is a favorite feed for stock. **Pkt. 5c; oz. 10c; ¼ lb. 15c; lb. 30c.**

SOUTHERN PRIZE—Very extensively grown in the South for greens. The plants furnish an abundance of tops. **Pkt. 5c; oz. 10c; ¼ lb. 15c; lb. 30c.**

YELLOW ABERDEEN—Very hardy and productive, a good keeper; globe-shaped; color pale yellow, with purple top. Very firm in texture, and closely resembling the Ruta-Bagas in good keeping qualities. Good either for table or stock. **Pkt. 5c; oz. 10c; ¼ lb. 15c; lb. 40c.**

EARLY WHITE EGG—An early, oval, or egg-shaped variety, with smooth, clear white roots of medium size, which grow half out of the ground. The flesh is clear white, firm, fine-grained and sweet. **Pkt. 5c; oz. 10c; ¼ lb. 15c; lb. 30c.**

RUTA-BAGAS, or SWEDES

AMERICAN IMPROVED PURPLE-TOP—Yellow-fleshed. An improvement over the ordinary Purple-Top in that it has a smaller and much shorter top. Splendid for family use or feeding stock. **Pkt. 5c; oz. 10c; ¼ lb. 15c; lb. 40c.**

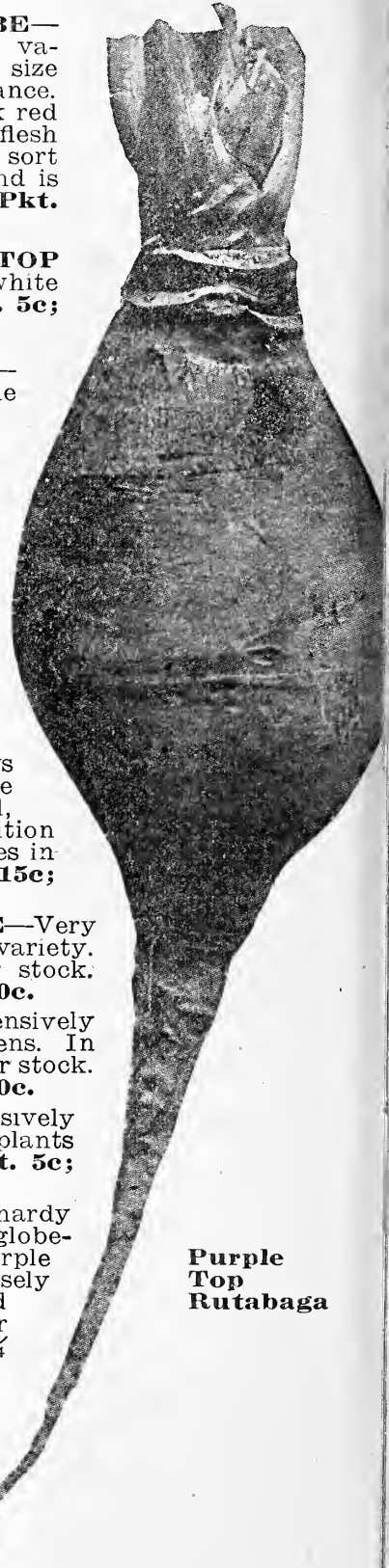

**Purple
Top
Rutabaga**

THE "WISDOM" TOMATO

For Quality and Productiveness
IT IS UNEXCELLED

INTRODUCED BY US NINE YEARS AGO AND STILL IN THE LEAD



THE "WISDOM" TOMATO Introduced and Grown Exclusively by WISEMAN-DOWNS CO.

From a very small quantity of seed which we obtained ten years ago, and after careful nursing and experimenting, we have developed the best medium-early Tomato ever introduced on this market. It is absolutely the very best for truckers, market gardeners and growers generally. It will readily sell and command a higher price from shippers, packers and retail markets as well. Before introducing it to the trade generally, we have tested it out under all climatic and soil conditions during the past several years. Notwithstanding the fact that last season was a poor one for the growing of Tomatoes, the few truckers that were lucky enough to obtain any of this seed said, "Their crops were excellent, and the last Tomatoes picked were as good as the first." We have on file a number of unsolicited testimonials, of which, owing to limited space, we publish a few. We have long realized the demand for a medium-early Tomato that would meet the requirements of both the packer and shipper and at the same time prove most profitable to the trucker and market gardener as well. In this we are sure that in the development of this wonderful Tomato we have met with success. Our Mr. J. W. Downs, who for years had been a successful trucker in Anne Arundel County, Md., and who personally supervises the growing of this seed, says, "It is the best he has ever seen." Tomatoes were his specialty. To those of our patrons who as yet do not know of the wonderful qualities of this Tomato, we would like to say: It is a perfectly smooth, deep red, medium-early and uniform Tomato. Just the right size and shape for packing, free from blight, heavy foliage, which protects the fruit from the hot sun rays, thus preventing sunscald; thick skin, which makes it the very best for shipping long distances; entirely free from core. Makes a splendid appearance when arranged on the market stall, as every one is perfectly uniform. Positively no culls. Ripens evenly to the stem. Will not crack or rot from too much rain, as is the case with some of the other sorts. Very thick-meat, and makes a splendid slicing Tomato for the table. We would suggest that, if only a small packet, try it, and you will not be disappointed in the crop. To avoid mistakes and imitation, we will only sell this in sealed packages at the following prices: **Pkt. 25c; oz. 75c; ¼ lb. \$2.25; 1b. \$8.00.** See that each package bears our label.

UNIVERSITY OF MISSOURI,
Columbia, Mo.

College of Agriculture,
Agricultural Experiment Station,
Department of Horticulture.

October 9, 1919.

Wiseman-Downs Seed Co., Baltimore, Md.:

Gentlemen—I have been informed by Prof. Gardner, of Pennsylvania State College, that two of your varieties of Tomatoes have shown up favorably this year, namely, the Wisdom and Kelly's Red. Since we are carrying on a rather extensive investigation with the Tomato crop in this State, I would like to have seed for testing next year. Also I would like to have as complete a description of these two varieties as possible. Undoubtedly you can supply this from your catalog or records.

Yours very truly,
J. T. ROSA,

Instructor in Horticulture.

"I have planted your 'Wisdom' Tomato for two years in succession, and the past season, being a bad one, I did not expect much from them, but as the season advanced I was agreeably surprised to see how well they stood the test. They not only gave me a good yield, but the quality was as good as ever went in cans."—JOHN H. CHAMBERS, St. Mary's County, Pearson, Md.

"The 'Wisdom' Tomato again produced a splendid crop for me this season, though we did have too much cold weather and rain the early part of season. Am well pleased with the Wisdom."—ANDREW WEST, Sparrow's Point, Md.

"The 'Wisdom' Tomato that I planted this year turned out better than any of the other varieties. You have my order in for next season,"—S. S. TRACEY, Brooklyn, Md.

Our Seeds are Best by Test

TOMATO

(German, Liebesapfel; French, Tomate; Spanish, Tomate)

CULTURE—Tomatoes do best on light, warm, not overrich soil, and success depends largely upon securing a rapid, vigorous and unchecked growth during the early part of the season. Sow in hotbeds from 6 to 8 weeks before they can be set out of doors, which is when danger from frost is past. When the plants have 4 leaves transplant into shallow boxes or cold frames, setting them 4 to 5 inches apart. Give plenty of air and endeavor to secure a vigorous but steady and healthy growth, so that at the time of setting in the open ground they will be strong and stocky. Even a slight check while the plants are small will materially diminish their productiveness. Set out of doors as soon as danger from frost is over, but before doing so harden off the plants by gradually exposing them to the night air and by the withdrawal of water until the wood becomes hard and the leaves thick and of a dark green color. Transplant carefully and cultivate well as long as the vines will permit.

Kelly's Red Tomato

This wonderful Red Tomato originated in Anne Arundel County, Md., a few years ago, and because of its good qualities has grown into favor with all who have tried it.

There are nine good reasons why every trucker or grower of Tomatoes should plant this most excellent sort: first, it is the most solid Tomato grown; second, its uniformity in size, being a good size, and not too large for canning; third, its good shipping qualities, remaining hard and firm in transit; fourth, its meatiness, being good and solid all the way through; fifth, its weight which is due to its firmness and solidity; sixth, its beautiful red color, which attracts the attention of the buyer, and therefore finds ready sale; seventh, it ripens right up to the stem and has no ridges; eighth, it never cracks, except when overripe; ninth, its productiveness, producing from 300 to 600 bushels per acre.

We are growing this seed under our careful supervision, and in order to protect the customer from imitations or substitutes it will only be sold in sealed packages.

If You Would Double the Yield of Your Tomato Crop, Plant the Kelly's Red.

Sold only in sealed packages, as follows: **Pkt. 10c; oz. 50c; ¼ lb. \$1.50; lb. \$5.00.**

NEW STONE—One of the largest and most solid late, bright red varieties. Vine large, vigorous and very productive. Fruits deep scarlet, nearly round or slightly flat. Smooth and uniform in size. **Pkts. 5c and 10c; oz. 15c; ¼ lb. 60c; lb. \$2.25.**

BONNIE BEST—Of recent introduction. Has proved to be, as its name signifies, the best early Tomato grown. About 10 days earlier than Chalk's Jewel, and nearly as early as Earliana. It is a strong, vigorous grower, very prolific, heavy foliage, which acts as a protection from the hot sun. The fruit is round, red, with delicious flavor, very uniform in size and shape. Does not have the green surface like the Earliana. **Pkts. 5c and 10c; oz. 30c; ¼ lb. \$1.25; lb. \$4.00.**

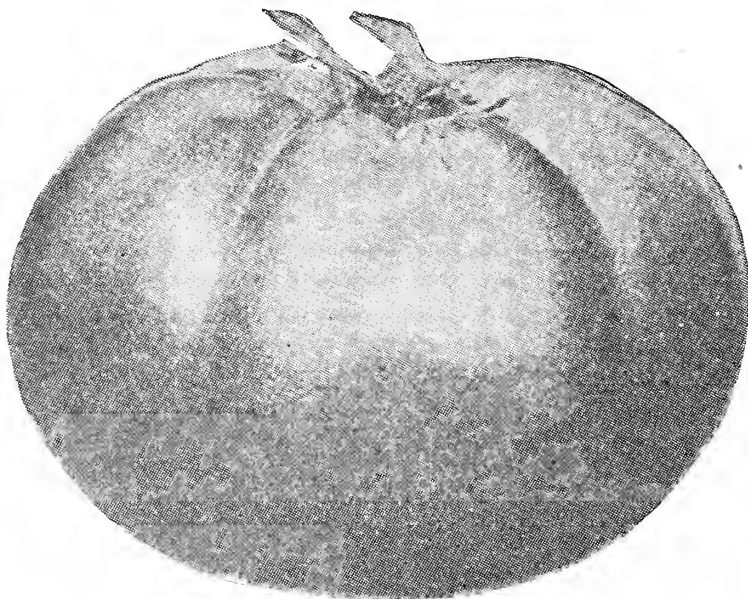

Kelly Red Tomato

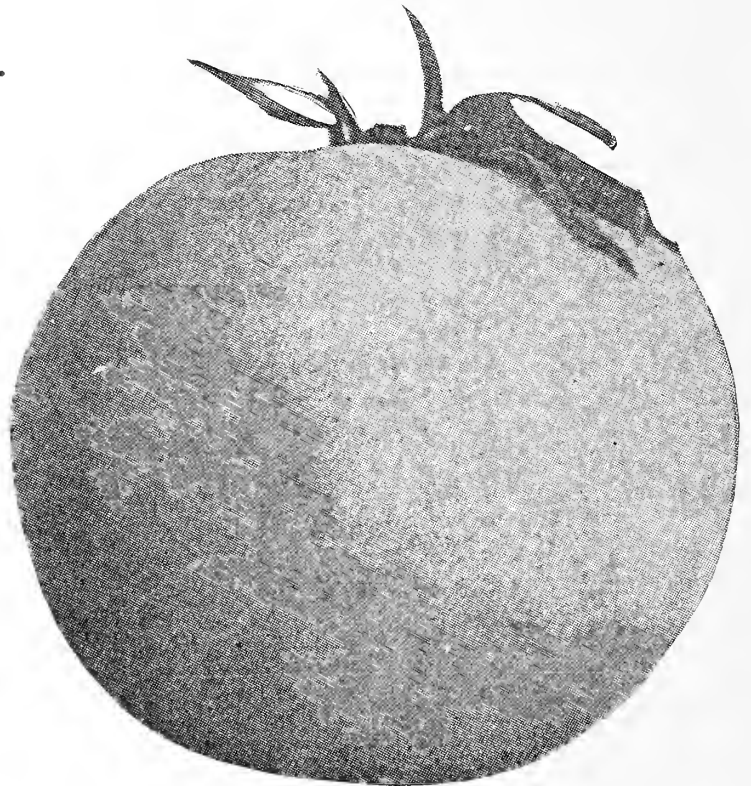

New Stone Tomato

MASCOT—This new variety has taken its place with the extra-early varieties, maturing a week later than Earliana and far superior in quality; color ruby red; globe-shaped, solid and an excellent flavor; very prolific. **Pkts. 5c and 10c; oz. 30c; ¼ lb. \$1.25; lb. \$4.00.**

CHALK'S EARLY JEWEL—Very large, smooth, red and especially fine-flavored variety. Within 10 days as early as Earliana. Very prolific. **Pkts. 5c and 10c; oz. 30c; ¼ lb. \$1.25; lb. \$4.00.**

JOHN BAER—Of recent introduction, it has grown into favor so rapidly until now it has taken its place along with the very earliest and best varieties. Color red, of medium size and excellent quality. **Pkts. 5c and 10c; oz. 30c; ¼ lb. \$1.25; lb. \$4.00.**

SUNNYBROOK—This is an extremely early variety, coming into maturity as early as the Earliana, and of a far better quality, of good size and a bright red color. Will stand shipping long distances much better than any of the very early varieties. **Pkts. 5c and 10c; oz. 30c; ¼ lb. \$1.25; lb. \$4.00.**

IMPROVED PONDEROSA—This variety as grown by us is quite smooth, of immense size, very solid and luscious. For family gardens it is deserving of universal use. Unsurpassed in size and of fine quality for slicing. The vines are of strong growth. The deep purple fruits are oblong in form and very fleshy, with small seed-cells; of extra-sweet flavor. We offer a selected strain of our own growing that produces Tomatoes smoother than usual and very meaty. **Pkts. 5c and 10c; oz. 30c; ¼ lb. \$1.25; lb. \$4.00.**

KING OF THE EARLIEST—One of the largest extra-early Red Tomatoes in cultivation, which well deserves its name. **Pkts. 5c and 10c; oz. 30c; ¼ lb. \$1.25; lb. \$4.00.**

Our Seeds are Best by Test



SPARK'S EARLIANA—The earliest of all Tomatoes. Especially valuable for this reason, being 10 days to 2 weeks earlier than any other sort. A bright red color; solid and very prolific. **Pkts. 5c and 10c; oz. 35c; ¼ lb. \$1.25; lb. \$4.00.**

EARLY I. X. L.—Very early and very prolific. Fruit large and of a bright red color. Firm and solid. Fine flavor. A favorite with the truckers. **Pkts. 5c and 10c; oz. 35c; ¼ lb. \$1.25; lb. \$4.00.**

ATLANTIC PRIZE—A splendid cropper. Large, red, and while not as smooth as Paragon, it ripens very evenly. **Pkts. 5c and 10c; oz. 15c; ¼ lb. 60c; lb. \$2.25.**

BEAUTY—A standard sort for early market and shipping. Firm and tough. Thick meat, of a fine flavor. A splendid shipping sort. Color rich crimson, tinged with purple. **Pkts. 5c and 10c; oz. 15c; ¼ lb. 60c; lb. \$2.25.**

MATCHLESS—The color is rich, bright red, and is of fine quality, although possibly not as firm as the Stone. **Pkts. 5c and 10c; oz. 15c; ¼ lb. 60c; lb. \$2.25.**

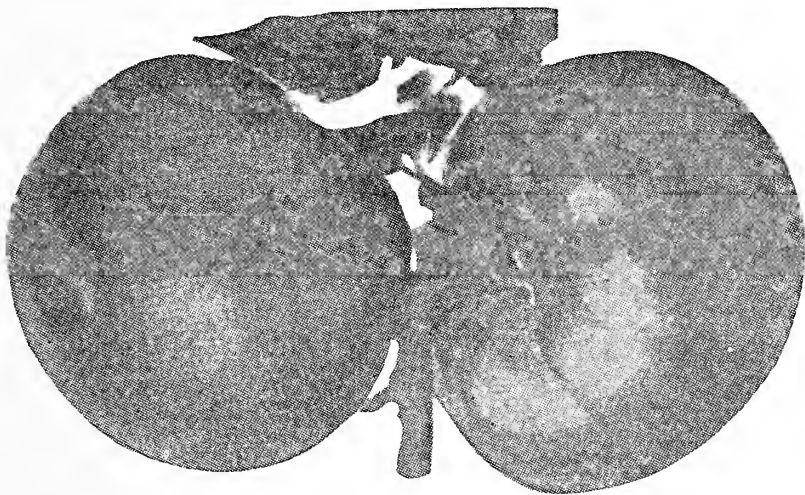

Spark's Earliana

DWARF CHAMPION—A fine variety, rather bushy and upright in growth. Smooth, purple fruit. **Pkts. 5c and 10c; oz. 35c; ¼ lb. \$1.25; lb. \$4.00.**

MY MARYLAND—A good medium-early sort and a heavy bearer. Excellent for truckers and market gardeners generally. A good packing variety. **Pkts. 5c and 10c; oz. 25c; ¼ lb. 90c; lb. \$3.00.**

BRINTON'S BEST, or B. B.—An excellent sort for canning and shipping; smooth, red and of fine flavor. **Pkts. 5c and 10c; oz. 15c; ¼ lb. 60c; lb. \$2.25.**

RED ROCK—One of the finest for canning, being very solid, smooth and red. Of fine flavor, very meaty and wonderfully free from acid. A heavy producer and good shipper. **Pkts. 5c and 10c; oz. 25c; ¼ lb. 90c; lb. \$3.00.**

GREATER BALTIMORE—Brilliant red color. Vines sturdy and vigorous. Very solid and firm. A good shipper. **Pkts. 5c and 10c; oz. 25c; ¼ lb. 90c; lb. \$3.00.**

LIVINGSTONE FAVORITE—Bright red, smooth Tomato, of good size. **Pkts. 5c and 10c; oz. 15c; ¼ lb. 60c; lb. \$2.25.**

PARAGON—Bright red, firm and smooth. So well known it needs no further description. **Pkts. 5c and 10c; oz. 15c; ¼ lb. 60c; lb. \$2.25.**

NEW QUEEN—This sort is well known among canners, resembling somewhat the Paragon. **Pkts. 5c and 10c; oz. 15c; ¼ lb. 60c; lb. \$2.25.**

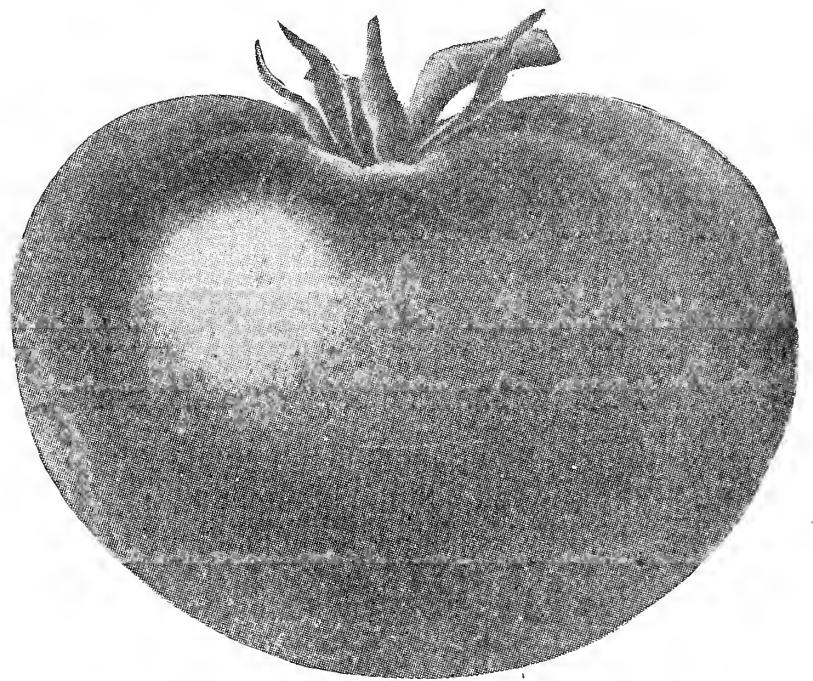

Red Rock Tomato

OTHER STANDARD SORTS

Per pkt. 5c of any of the following:

	Oz.	¼ Lb.	Lb.
Atlantic Prize. Early, red.....	\$0.15	\$0.60	\$2.25
Buckeye State. Late, purple....	.15	.60	2.25
Early Freedom. Very early.....	.15	.60	2.25
Favorite. Early, smooth, red; good shipper.....	.15	.60	2.25
Golden Queen. Rich yellow.....	.15	.60	2.25
Honor Bright. Best shipper; good quality.....	.15	.60	2.25
Imperial. Early, purple.....	.15	.60	2.25
Perfection. Solid flesh, blood red, late, a favorite.....	.15	.60	2.25
Trophy. Old standard, late.....	.15	.60	2.25

SMALL-FRUITED VARIETIES

PEAR-SHAPED YELLOW—Used for preserving and pickles. **Pkts. 5c and 10c; oz. 45c; ¼ lb. \$1.50.**

YELLOW PLUM—Color bright yellow; excellent for preserving. **Pkts. 5c and 10c; oz. 40c; ¼ lb. \$1.50.**

PEAR-SHAPED RED—**Pkts. 5c and 10c; oz. 40c; ¼ lb. \$1.50.**

We make a specialty of growing Tomato Seed. We mean ACTUAL GROWING. Some who claim to be extensive growers in this line, we find, raise a large portion of their output at the back door of some canning factory—simply saving the seed from the refuse. Such seed may be a mixture of a half-dozen or more varieties. We grow our Tomatoes only for Seed. We select our seed from the choicest Tomatoes which are most perfect in form and true to type.

All Prices Subject to Change Without Notice

SEED POTATOES NORTHERN GROWN

CULTURE—Potatoes thrive better on light sandy soil, yet under favorable conditions a good crop may be obtained on heavier soil. If stable manure is to be used, see that it is well rotted and not allowed to come in contact with the tuber. Make rows 3 feet apart and plant about 8 or 10 inches apart in the rows. Cover seed about 4 inches if ground is warm and dry; if cold and wet, cover 3 inches. Cultivate frequently to keep down the weeds. As the vines increase draw the earth around them, forming a slight ridge. When the bugs appear dust with Paris Green. Plant from 8 to 10 bushels to the acre.

EARLY OHIO—Very early and productive; shape oblong; fine quality, being dry and mealy. A splendid keeper. **Pk. (15 lbs.) 90c; bu. (60 lbs.) \$3.00; bbl. (165 lbs.) \$6.50.**

BLISS TRIUMPH—One of the very early sorts; very productive; handsome color; a favorite with the



BEAUTY OF HEBRON

Potato grower. **Pk. (15 lbs.) 90c; bu. (60 lbs.) \$3.00; bbl. (165 lbs.) \$6.50.**

BEAUTY OF HEBRON—Vine vigorous and a rapid grower. Early and prolific. Resembles somewhat the Early Rose, but is more productive. An excellent Potato for the

table either boiled or baked. **Pk. (15 lbs.) 90c; bu. (60 lbs.) \$3.00; bbl. (165 lbs.) \$6.50.**

CROWN JEWEL—Very early and prolific; skin pinkish-white. One of the best for early market. Planted extensively in this section and also the South. **Pk. (15 lbs.) 90c; bu. (60 lbs.) \$3.00; bbl. (165 lbs.) \$6.50.**

EARLY NORTHER—Resembles the Early Rose in shape and color; matures a few days earlier, and is a favorite with those who have tried it. **Pk. (15 lbs.) 90c; bu. (60 lbs.) \$3.00; bbl. (165 lbs.) \$6.50.**

NEW YORK EARLY ROSE—A leading variety for earliness, quality and productiveness. **Pk. (15 lbs.) 90c; bu. (60 lbs.) \$3.00; bbl. (165 lbs.) \$6.50.**

RURAL NEW YORKER—A valuable variety, of large size, very smooth and a great cropper; in quality unexcelled. This variety is yearly becoming more popular as the best late long keeper, and we recommend it highly. **Pk. (15 lbs.) 60c; bu. (60 lbs.) \$2.50; bbl. (165 lbs.) \$6.50.**

SPRAY YOUR POTATOES WITH PYROX

Pyrox Means Prize Potatoes. Insure your potato crop against potato bugs, flea beetles and blight by spraying—in time—with Pyrox. 1 pound to 5 gallons of water. Then you are safe against pest-losses. You will get bigger potatoes and more of them too, for Pyrox stimulates the plant, giving the leaves that rich, green color which means maximum starch formation. And more starch means more and heavier tubers. Nineteen years of use by this country's best potato growers have proved that, without Pyrox, you can't get the greatest returns from your soil, no matter how carefully you prepare and fertilize it. Pyrox is the cheapest spray to use, too—the increased yield and quality soon pay for it besides giving you a good profit.

For Other Vegetables—Growers of tomatoes, sweet potatoes, eggplant, cabbage and other vegetables find that Pyrox is as invaluable a profit-builder for them as for potato growers. And for the same reasons. Pyrox safeguards the plants against chewing insects, prevents rots and blights and nourishes the leaves—the lungs of the plant. Better crops and better-selling vegetables are the natural results.

For Prices, see Insecticides.

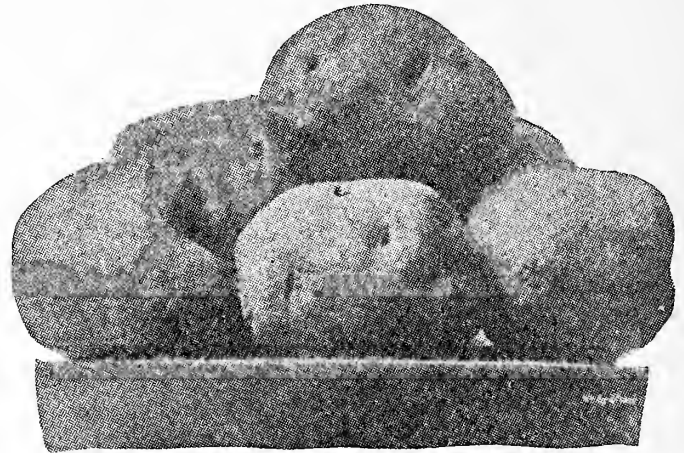

PROSPERITY—An extra large cropper; medium early; flesh white; cooks white and mealy. **Pk. (15 lbs.) 90c; bu. (60 lbs.) \$3.00; bbl. (165 lbs.) \$6.50.**

MAGGIE MURPHY—Very productive, oblong, somewhat flattened. **Pk. (15 lbs.) 90c; bu. (60 lbs.) \$3.00; bbl. (165 lbs.) \$6.50.**

McCORMICK—A very late and heavy cropper; one of the best for Winter keeping. **Pk. (15 lbs.) 60c; bu. (60 lbs.) \$2.50; bbl. (165 lbs.) \$6.50.**

MAINE, or HOULTON EARLY ROSE—An old standard variety, so well known that it needs no description. Our stock of this variety is the very best. **Pk. (15 lbs.) 90c; bu. (60 lbs.) \$3.00; bbl. (165 lbs.) \$6.50.**

BURBANK—An old and well-known sort; oblong; white skin and flesh. A very heavy yielder and a splendid Potato for cooking. Late and a good keeper. **Pk. (15 lbs.) 60c; bu. (60 lbs.) \$2.50; bbl. (165 lbs.) \$6.50.**

IRISH COBBLER—One of the most popular sorts on the market; a favorite with the trucker; very productive; matures early; shape is chunky, almost round; very strong and deeply set; skin is netted; flesh white. **Pk. (15 lbs.) 90c; bu. (60 lbs.) \$3.00; bbl. (165 lbs.) \$6.50.**

GREEN MOUNTAIN—A splendid late-crop variety; an excellent keeper; very prolific. **Pk. (15 lbs.) 60c; bu. (60 lbs.) \$2.50; bbl. (165 lbs.) \$6.50.**

DAKOTA RED—A very late variety and yields even better than the McCormick. Oblong in shape; color red; flesh white and will cook dry and mealy; keeping qualities unexcelled; will yield from 25 to 35 bushels to one planted. Not to be confounded with the McCormick, as it is a true and distinct variety and of much better quality. **Pk. (15 lbs.) 90c; bu. (60 lbs.) \$3.00; bbl. (165 lbs.) \$6.50.**

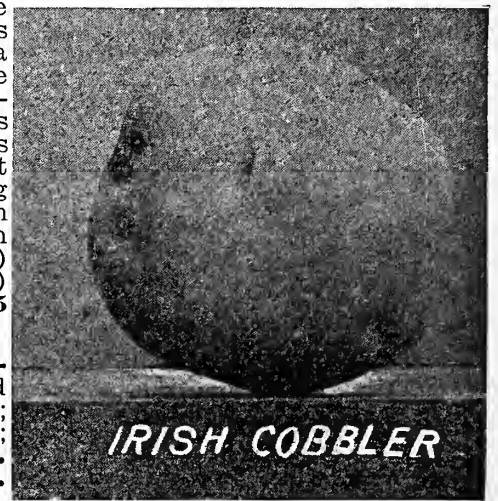

IRISH COBBLER

SWEET POTATOES

We make a specialty of Sweet Potatoes, and in season can supply all the leading varieties.

Write for Prices.

FIELD CORN

BOONE COUNTY WHITE—This is the prize winner. It is a medium-late Corn, requiring about 110 to 120 days to mature the grain. Grows a large, heavy, well-bladed fodder, and is an excellent Corn both for the crib or silo. The ears are from 9 to 12 inches long and well proportioned, running about 20 to 22 rows of deep grain on a medium-sized, pure white cob, with deep, well-filled medium shank, allowing ear to droop as it matures and excluding the moisture. The tips are also well filled, often completely covered. The kernels are of the Dent variety, moderately rough, very deep and wedge-shaped and form straight, compact rows. It will produce 20 to 25 tons ensilage per acre, and the cured fodder makes excellent dry provender. On good ground it will average 18 to 20 tons per acre. **Pk. 90c; bu. \$3.00.**

NINETY-DAY RED COB—Can be used either as a roasting ear or, when fully matured, makes an excellent Corn for feeding stock. Matures in about 90 days. **Qt. 15c; pk. \$1.00; bu. \$3.50.**

WHITE KAFFIR CORN—This variety belongs to the Sugar Cane family, and has great drought-resisting qualities. The grain is used for feeding poultry and the fodder for cattle. It is ideal for planting where the Corn seed has failed to germinate, and it is too late to replant. Grows from 4 to 6 feet high, the grain being produced on the top of a stalk in the shape of a brush. Plant at the rate of 10 pounds to the acre, in drills. **Lb. 10c.**

EVERGREEN BROOM CORN—The chief value of this plant lies in the top, or brush, as it may be called, which is used in making brooms. The stalk is used for bedding, and grows to a height of about 9 feet. Sow in May, about 10 pounds to the acre, in drills 3 feet apart. **Lb. 15c.**

"HICKORY KING" WHITE CORN—So large are the grains and so small the cob that on an ear broken in half a single grain will almost cover the cob section. Of a strong growth, the stalks take a firm hold in the ground and stand upright, resisting severe storms. It yields splendid crops on light soils and is undoubtedly the best and most productive White Field Corn for the South. **Pk. 90c; bu. \$3.00.**

CUBAN GIANT ENSILAGE CORN—Grains are

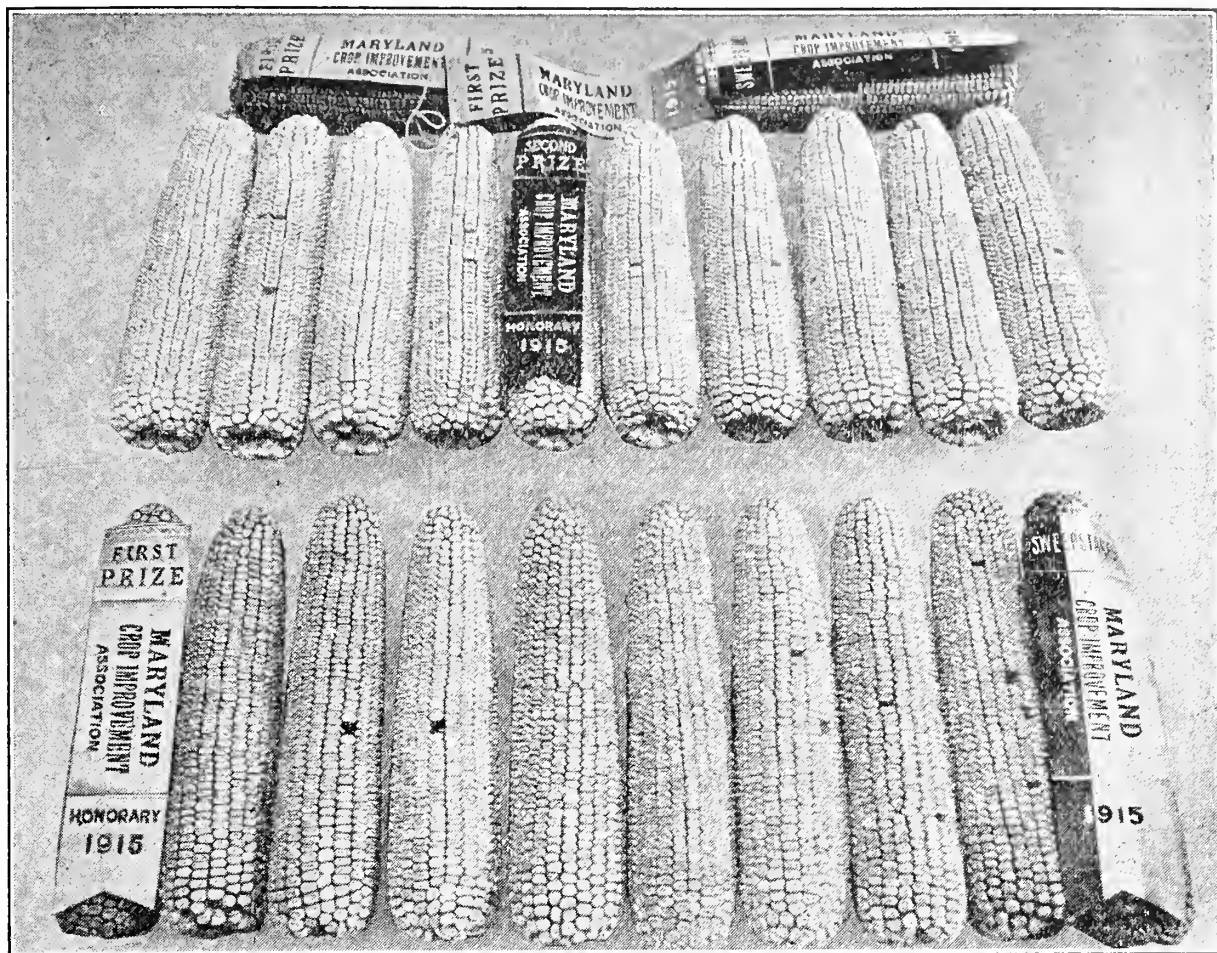

pure white, very large, broad and long. Of stronger vitality than any other variety. It is the best milk producer of all Ensilage Corns, being as sweet as Sugar Corn. Outyields the Red-Cob Ensilage and is 10 to 12 days earlier. **Pk. 80c; bu. \$2.75.**

MARYLAND WHITE CORN—Very popular with the farmer, as it is a standard variety, and very well known. Large pure white grain, small cob, good-sized ear. **Qt. 15c; pk. 90c; bu. \$3.00.**

FUNK'S YELLOW DENT—A standard variety of Yellow Dent Corn. Slender grains, of a beautiful golden yellow. The kernels grow very close together. Small cob; good yielder. **Qt. 15c; pk. 90c; bu. \$3.00.**

GOLDEN BEAUTY—Very large, broad grains, arranged very evenly on gigantic cobs. The fodder is enormous, often growing 12 feet high. Matures late, but yields wonderful crops. Desirable for silo and ensilage purposes. **Qt. 15c; pk. 90c; bu. \$3.00.**

EARLY LEAMING—Its extreme earliness has made it a favorite with the farmer, and especially with those in the localities where the seasons are short. Ears and grains are of medium size. **Qt. 15c; pk. 90c; bu. \$3.00.**

BLOUNT'S PROLIFIC—A very prolific, flinty, white sort. Produces from 3 to 5 ears to a stalk; makes excellent meal. **Pk. 90c; bu. \$3.00.**

CLOVER SEEDS

ALSIKE, or SWEDISH (Trifolium Hybridum)—The most hardy of all Clovers; perennial. On rich, moist soil it yields an enormous quantity of hay or pasturage, but its greatest value is for sowing with other Clovers and Grasses, as it forms a thick bottom and greatly increases the yield of hay. Sow the seed in Spring or Fall, at the rate of 10 to 15 pounds per acre, when sown alone. **Lb. 30c.** Write for prices in larger quantities.

ALFALFA, or LUCERNE (Medicago Sativa)—The most valuable forage crop on the farm today. It is sown during May, August and September, these being the best months for success, although it can be sown at other times with a possible chance of doing well. It should not be planted on land having a stiff clay or hard pan subsoil, as the roots naturally penetrate to a great depth, and must do so if the plants live any time. Sow on rich, moist loam or sandy soil having a deep,

porous subsoil. Prepare the land thoroughly and sow seed at the rate of 15 to 25 pounds per acre. The young plants are very tender, and should be kept free from weeds. The seed we offer is grown on Montana high land and seems to do better than that grown on low or irrigated land. **Lb. 30c.** Write for prices in larger quantities.

RECLEAVED RED (Trifolium Pratense)—This is by far the most important of all the varieties for practical purposes. Sow in Spring or Fall, and if no other grasses are used, at the rate of 15 pounds per acre. **Lb. 30c.** Write for prices in larger quantities.

WHITE DUTCH (Trifolium Repens)—A small, creeping perennial variety, valuable for pasturage and for lawns. It accommodates itself to a variety of soils, but prefers moist ground. $\frac{1}{4}$ lb. 15c; lb. 50c.

GRASS SEEDS

TIMOTHY (*Phleum Pratense*)—The most valuable of all the grasses for hay; thrives best on moist, loamy soils of medium tenacity. It should be cut just when the blossom falls. Sow early in the Spring or Fall, at the rate of 15 pounds per acre if alone, but less if with other grasses. **Lb. 15c.** Write for prices in larger quantities.

KENTUCKY BLUE GRASS (*Poa Pratensis*)—It is the most nutritious, hardy and valuable of all Northern grasses. Sown with White Clover, it forms a splendid lawn. If sown by itself for meadow or pasture, use about 28 pounds per acre. **Lb. 60c.** Write for prices in larger quantities.

ORCHARD GRASS (*Dactylis Glomerata*)—Desirable for its quick growth and valuable aftermath. It is ready for grazing 2 weeks earlier than any other grasses, and when fed off is again ready for grazing in a week, and will continue green after all other grasses are withered by dry weather. It is palatable and nutritious, and stock eat it greedily when green. If sown alone, about 28 pounds per acre are required. **Lb. 30c.** Write for prices in larger quantities.

AWNLESS BROME GRASS (*Bromus Inermis*)—A perennial, valuable for binding the soil of embankments and for resisting both drough and cold. Sow 40 pounds per acre. Write for prices.

PERENNIAL RYE GRASS (*Lolium Perenne*)—A very valuable variety for permanent pasture. Succeeds well on almost any soil, but is particularly adapted to moderately moist or irrigated lands. Sow 30 to 40 pounds per acre in Spring. Write for prices.

RED TOP (*Agrostis Vulgaris*)—This is known as Herd's Grass. It is a good, permanent grass, standing our climate well, and makes good pasture when fed close; is valuable for low, wet meadows, producing a large return in hay. When sown alone, use about 28 pounds of the chaff seed per acre. Sow in Spring or Fall. Write for prices.

RED-TOP FANCY (Cleaned from Chaff)—Sow 8 to 10 pounds per acre. **Lb. 25c.** Write for prices.

RED-TOP UNHULLED (Free from Light Chaff)—**Lb. 10c.** Write for prices in larger quantities.

SHEEP PESCUE (*Festuca Ovina*)—A small, tufted, hardy Grass, forming a cluster of narrow, cylindrical leaves. It is of value in mixture for lawns on dry soils and in shady locations. Sow about 35 pounds per acre. Write for prices.

RHODE ISLAND BENT GRASS (*Agrostis Canina*)—A valuable perennial for lawns and pasturage. Much like Red-Top, only smaller. Thrives on light, dry soils as well as on rich, moist ones. Write for prices.

WOOD MEADOW GRASS (*Poa Nemoralis*)—Grows from 1½ to 2 feet high; has a perennial, creeping root, and an erect, slender, smooth stem. Well adapted to shaded places, such as orchards and parks, for either hay or pasturage. Sow about 30 pounds per acre. Write for prices.

CREEPING BENT GRASS (*Agrostis Stolonifera*)—Particularly valuable for lawns that are to be used as croquet and tennis grounds. Makes a low, velvety growth. Write for prices.

MEADOW FESCUE, or ENGLISH BLUE GRASS (*Festuca Pratensis*)—A perennial from 2 to 4 feet high, with flat, broad leaves. One of the standard European Grasses. It succeeds well on nearly all soils, but does best on upland, loamy or moderately stiff soils. An excellent pasture Grass to take the place of the wild grasses, as it yields a large amount of early and late feed. Sow about 40 pounds per acre. Write for prices.

TALL MEADOW OAT GRASS (*Avena Elatior*)—A hardy perennial, much used in the South and West. Roots penetrate deep. It yields a heavy crop on any good soil, and is valuable both for meadow and pasture. Write for prices.

Wiseman-Downs Co.'s "Wisdom" Evergreen Lawn Grass



PREPARATION AND CARE OF LAWNS

The essentials for a fine lawn are: first, a well drained soil; second, careful preparation of the ground, making it as fine and smooth and mellow as possible; third, a wise selection of seeds; fourth, sowing at such a time as to give the young plants a chance to become well established before being subjected to very dry or cold weather or to the direct rays of the hot Summer sun. However much care is bestowed on the soil and seed, no lawn will be beautiful without frequent mowing and rolling. Too much care cannot be bestowed upon the selection of Grasses, as some varieties are the most luxuriant in Spring, others in Summer, others in Autumn, and a combination of the proper sorts is required for a perfect carpet-like lawn. It may be planted early in Spring or Fall, and should be sown at the rate of 60 to 100 pounds per acre; much more is required than for hay or pasturage. If sown in the Spring, sow as early as possible, making the surface very fine and smooth, then raking it over and sowing the seed just before a rain, which, if the surface has just been raked, will cover the seed sufficiently. If the expected rain does not come cover by rolling with a light roller. For Fall seeding, sow before the Autumn rains and early enough to enable the young Grass to become well established before very cold weather, when a light dressing of manure should be given.

"WISDOM" EVERGREEN LAWN GRASS—Our "Wisdom" Evergreen Lawn Grass is prepared with the utmost care. Nothing but the very best and choicest seeds are allowed to enter into it, and only those which are best suited for lawns. We feel that we are offering a thoroughly first-class mixture, made of the best and cleanest grades of those varieties used and best adapted to general lawn purposes, and should not be confounded with the cheap, chaffy grasses offered at a lower price. **½ lb. 30c; 1 lb. 50c; 5 lbs. \$2.25; 20 lbs. \$8.00.**

PARK LAWN GRASS—For those desiring a cheaper grade of Lawn Grass, this will be found a very excellent mixture, though, of course, it does not contain all the high-grade seeds which are used in the "Wisdom" Grass. **½ lb. 25c; 1 lb. 40c; 5 lbs. \$1.75.**

TERRACE SOD MIXTURE—**Lb. 40c; 5 lbs. \$1.75.**

SHADY NOOK LAWN GRASS—**Lb. 50c; 5 lbs. \$2.25; 20 lbs. \$8.00.**

Our Seeds are Best by Test

MISCELLANEOUS FARM SEEDS

We exercise the same care in the selection of stocks of all lines of Farm Seeds as we do the critical Vegetable and Flower Seed part of the business, and to this fact we attribute our success in this particular line of goods during the past season.

DWARF ESSEX RAPE—This makes an indispensable green food for sheep and hogs. It can be pastured 8 weeks after sowing. The growth is enormous. If one has the available land, it is good to sow in succession, as the stock eat it close to the ground, and it will not stand pasturing any great length of time. This, of course, depends upon the number of head turned on an acre. Sow 6 pounds per acre broadcast from April 1st to October 1st. It produces enormous crops and is an ideal green manure. Write for prices.

VETCHES, or TARES—This has been used in Europe for many years as a stock food and green manuring of cover crop. It does best if sown with Rye, the latter giving it support, and thus insuring enormous crops. It makes an ideal hay, and it is a pity that every American farmer does not use it. It fertilizes the ground without further trouble or cost, on account of the free nitrogen it gathers from the air. It produces a peculiar vine plant, with very narrow foliage and elongated flowers of pinkish-white in clusters. Write for prices.

WINTER, or HAIRY VETCHES (Vicia Villiosa)—Sow from August 1st to October 1st, 1 to 2 bushels per acre, to which we suggest adding a bushel of Winter Rye or Wheat. Write for prices.

COW PEAS—These are the best, largest yielding and most nutritious of the farm crops. They provide the most inexpensive methods of bringing soil back to a state of fertility. In the South it is the staple forage crop for Winter feeding. They grow in the poorest kind of soil, taking the free nitrogen from the air, which it deposits in the ground through the roots, leaving it very rich in ammonia. Sow from May 1st to July 1st, 2 bushels per acre broadcast, or 1 bushel per acre in drills. Write for prices.

WHIPPOORWILL—Seed is reddish-brown speckled. Some claim that this variety is capable of gathering more nitrogen than others. Write for prices.

BLACK COW PEAS—This is a quick-growing variety, desirable for turning under. Write for prices.

WONDERFUL, or UNKNOWN—An enormous producer, very late in maturing. Write for prices.

NEW ERA—An early upright-growing variety; smaller seed.

SOJA BEANS—The great drought-resisting forage crop. A soil enricher, because of its nitrogen-gathering qualities. The fodder is relished in either green or dry form by cattle or dairy cows. Write for prices.

CHOICE SEED OATS—In these we offer only the very best varieties. Write for prices.

GERMAN MILLET—Excellent for planting when other hay crops are short, as it is a very rapid grower and produces a very fine crop of hay. Write for prices.

HUNGARIAN MILLET—The seed is a mixture of brown and yellow; the quality of the hay is not quite as good as the German; it can, however, be sown 2 weeks later. Write for prices.

WINTER WHEAT—In season we carry a large stock of the best varieties.

RYE—We carry both Winter and Spring Rye of the best quality. Write for prices.

SUNFLOWER, MAMMOTH RUSSIAN—This makes an excellent poultry food especially for Winter use, on account of its fattening and heating qualities. Will yield sometimes as high as 60 bushels per acre. Lb. 10c.

Inoculate Your Alfalfa, Clovers, Cow Peas, Soy Beans, Vetches, and All Other Legume Crops With

Mulford Cultures

FOR LEGUMES

Small Cost Easy to Use Large Returns No Labor Expense

Mulford Cultures contain pure, tested strains of active, vigorous nitrogen-fixing bacteria, for inoculating seeds of legumes or soils.



Uninoculated ALFALFA Inoculated
Photographed on same scale. Plant on left
not inoculated—Plant on right inoculated
with **Mulford Culture for Alfalfa**. All
other conditions identical.

The Contrast Speaks for Itself.

Mulford Cultures are scientifically prepared and tested with the utmost care and skill. Enormous numbers of these very valuable and desirable bacteria are thus available to you in every package of Mulford Culture, and may readily be applied to your seed. The sealed bottle insures purity.

Legumes offer the best-known means of maintaining soil fertility and rejuvenating over-cropped and worn-out fields. They add both humus and nitrogen to your soil, and thus increase your yield of wheat, cotton, corn and other non-legume crops.

The U. S. Department of Agriculture and many State Agricultural Experiment Stations recommend inoculation of legumes with nitrogen-fixing bacteria to induce a prompt "catch" and increase your yield.

Mulford Cultures are prepared for

ALFALFA (Lucerne)	COW PEAS	GARDEN PEAS
CRIMSON CLOVER	SOY BEANS	GARDEN BEANS
SWEET CLOVER	PEANUTS	LIMA BEANS
RED CLOVER	VETCH	LESPEDEZA
ALSIKE CLOVER	VELVET BEANS	BEGGAR WEED
BURR CLOVER	SWEET PEAS	AND OTHERS

Always specify on your order what crop you want to inoculate, as there is a different strain of bacteria for each legume.

PRICES:

5-Acre Size, \$5.00 (A Dollar per Acre). 1-Acre Size, \$1.50. ¼-Acre Size, \$0.50. Small Size (supplied only in 4 varieties, for Garden Peas, Garden Beans, Lima Beans and Sweet Peas), \$0.25. These prices include delivery on freight shipments.

FREE DESCRIPTIVE LITERATURE SENT UPON REQUEST.

Best by Every Test

WISEMAN-DOWNS CO.

FLOWER SEEDS

(a.) **ANNUALS** are those flowers that bloom and ripen their seed the first year, then die. Among these will be found Asters, Balsam, Mignonette, Sweet Peas, Nasturtiums, Morning Glories, and many other very brilliant and fragrant flowers. In fact, if you want flowers early in the season, and all the time until frost, a good selection of Annuals will not disappoint you.

(p.) **PERENNIALS** are those flowers that endure our Winters with little or no protection, and live and bloom several years in succession. A large majority of the Perennials will bloom the first year if started early in the Spring. Hollyhocks, Larkspurs, Foxglove, Poppies, etc., are in this popular class.

SUCCESS WITH FLOWER SEEDS

We are convinced that many of the failures with Flower Seeds are due to lack of proper conditions and while it would be impossible in the space at our disposal in this catalogue to give explicit directions for each and every variety which we offer (but which is given on each packet of Flower Seeds we sell), we feel sure that if the general directions given below are followed success will be the rule. These directions, we may say, are written for the latitude of Baltimore. Customers living in other sections can readily adapt them to their localities.

For all Flower Seeds which should be started indoors—and this includes many of our best and brightest Summer flowers, such as Heliotrope, Celosia, Lobelia, Salva, Vinca, Verbenas, etc.—the best plan is to sow in earthenware seed pans, or boxes (about 2 inches deep), which should be filled to the depth of an inch with broken pots, coal ashes, or any rough material that will furnish perfect drainage. The upper inch should be nicely sifted soil, composed, if possible, of about one-third each of sand, leaf mould and light garden loam. Press firmly and evenly and water thoroughly the day before sowing. Sow the seeds thinly over the surface, cover about one-eighth of an inch and pressing firmly; cover with a pane of glass or one or two thickness of newspaper to prevent the too rapid evaporation of the moisture and keep in a temperature between 60° and 70°. Water carefully as needed. The importance of uniform attention to this detail is one that can only be learned by experience and observation. To omit a single watering, or too frequent, indiscriminate watering, usually leads to failure. Remove the glass, or covering, as soon as the seeds have germinated, and when the seedlings are large enough to handle they should be transplanted into similarly prepared boxes an inch apart each way, or put into small pots and kept in same until time to plant out in the open ground. At all times they should have an abundance of air; otherwise the young seedlings are liable to "damp off."

For most of the ordinary annual flowers, such as Sweet Alyssum, Calliopsis, Calendula, Marigold, Mignonette, Nasturtium, etc., the simplest method is to sow directly out of doors when danger of frost is past in the space where they are intended to flower. The ground should be dug and raked fine on the surface, sowing the seeds evenly and thinly, either in lines or beds, covering not over four times their size, and firming the soil over them. Should they come up too thickly, as most of them are likely to do, thin out so that the plants will stand from 4 to 12 inches apart, according to the variety. This plan is also adapted to many varieties usually started indoors, including Asters, Verbenas, Celosias, Stocks, Salva, etc.; but as a rule their germination is more certain under glass, and as they begin, to flower so much earlier when started indoors, the extra trouble is well repaid for by their increased blooming period.

ALYSSUM

Free flowering, pretty little plants for beds, edgings, or Winter blooming. The white varieties are hardy annuals and bloom all Summer.

LITTLE GEM—New, very dwarf, each plant covering a circle of about 5 inches. **Pkt. 5c; oz. 60c.**

SWEET ALYSSUM—White. **Pkt. 5c; oz. 65c.**

AGERATUM—Profuse blooming plants, bearing clusters of feathery blooms the whole Summer. Excellent for cut flowers and fine for large beds in Summer and as pot plants for Winter. Hardy annual. Height 2 feet.

Dwarf Mixed—**Pkt. 5c; oz. 60c.**

AMARANTHUS—Showy plants, some remarkable for large panicles of showy flowers and others for the brilliant range of colors in the leaves.

Caudatus (Love Lies Bleeding)—Long red panicles. **Pkt. 5c; oz. 30c.**

Tricolor (Joseph's Coat)—Yellow, red and green. **Pkt. 5c; ¼ oz. 20c.**

ANTIRRHINUM (Snap Dragon)—One of the most charming of old-fashioned flowers. The antirrhinum is a biennial, and blooms well the second season, but succeeds also as an annual. **Pkt. 5c; oz. 60c.**

PERFECTION PAEONY FLOWERED ASTERS (Truffauts)—One of the handsomest sorts. The plants grow from 18 to 24 inches high; the flowers are borne on long wiry stems, are very large, from 3 to 4 inches in diameter, very bright and delicate, and altogether this Aster is nearly perfection.

Mixed—**Pkt. 10c; oz. \$1.75.**

NEW COMET QUILLED ASTER—A very beautiful novelty in Comet Asters, the center of which consists of white, making a delightful contrast with the exquisite rose-colored outer petals. One of the most charming of the new Asters. Grows about 1½ feet high. **Pkt. 10c; oz. \$1.75.**

SEMPLE'S BRANCHING ASTERS—Beautiful Asters for cut flowers. Flower so large often mistaken for Chrysanthemum, which it closely resembles. Blooms from August 15 to end of season. The flowers are borne on long, graceful stems from 15 to 20 inches in length, one plant often covering a space of 2½ feet square. It is by far the most satisfactory late Aster grown.

Mixed—**Pkt. 10c; oz. \$1.50.**

CANNA—(a.) One of the finest bedding plants. **Pkt. 5c; oz. 20c.**

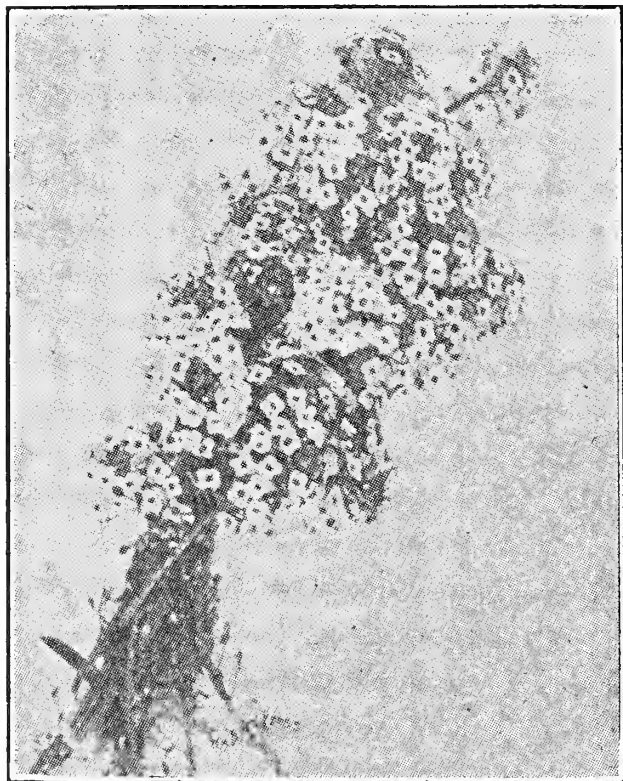

Alyssum

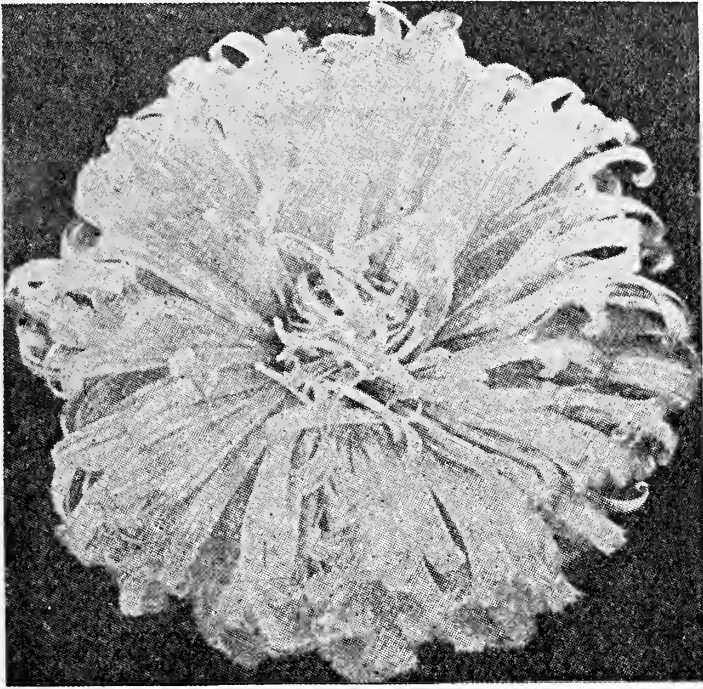

Aster

CALLIOPSIS, or COREOPSIS (Golden Wave)—(a.) Showy, free flowering, hardy annuals, of easy cultivation. Choicest mixed. **Pkt. 5c; oz. 25c.**

CANDYTUFT—Mixed for beds and massing. **Pkt. 5c; oz. 25c.**

CELOSIA (Coxcomb)—(a.) Free blooming; grand for borders and very good for pots. Mixed. **Pkt. 5c; oz. 75c.**

CENTAUREA CYANUS (Batchelor Button, or Corn Flower)—(a.) Beautiful, sweet-scented flowers; one of the finest annuals. Choicest mixture of very fine colors. **Pkt. 5c; oz. 30c.**

CENTUREA (Dusty Miller)—(a.) For borders; beautiful silver leaves. **Pkt. 10c; ¼ oz. \$1.50.**

CHRYSANTHEMUM—(a.) Showy and effective garden favorites. These Summer-flowering border plants are quite distinct from the Autumn-flowering varieties. Double fringed; mixed, yellow and white. **Pkt. 5c; oz. 50c.**

CINERARIA (Maritima Candidissima)—Fine for bedding, ribbon beds and margins. Beautiful silvery foliage. **Pkt. 5c; ¼ oz. 20c.**

COSMOS—(a.) An Autumn-flowering plant; a charming, profuse bloomer. Giant Rainbow variety, frilled. All colors mixed. **Pkt. 5c; oz. 50c.**

Cosmos—(a.) Early flowering; large-flowering kinds. **Pkt. 5c; oz. 50c.**

CYPRESS VINE—Popular vine, fernlike foliage and masses of beautiful small star-shaped flowers. White and scarlet, mixed. **Pkt. 5c; oz. 30c.**

CAMPANULA (Bellflower, Canterbury Bell)—Favorite old-fashioned, hardy plants. Beautiful and constant bloomers.

Choicest Mixed—Embraces all the popular single and double sorts. **Pkt. 10c; ¼ oz. 75c.**

CALENDULA (Pot Marigold)—Free-flowering mixed. **Pkt. 5c; oz. 25c.**

CALCEOLARIA—Makes a splendid window display. Flowers bloom in the greatest profusion through Spring and Summer. **Pkt. 50c.**

CARNATION (Marguerite)—Mixed. These lovely, fragrant flowers are in full bloom in about 4 months after sowing. Plants succeed alike in the open garden or in pots, and are of such vigorous, dwarf, erect growth that no supports are required. The range of color, marking, variegations and shading are simply wonderful. **Pkt. 10c; oz. \$1.00.**

CANTERBURY BELLS—Hardy biennial, flowering the second season from seed. 2½ feet high, producing large bell-shaped flowers of exquisite color. **Pkt. 10c; ¼ oz. 75c.**

CLARKIA—Charming garden annuals. The flowers of rose, white, red, purple, etc., borne in profusion during Summer. 1 to 2 feet. **Pkt. 5c; ¼ oz. 20c.**

CLEMATIS—Fragrant, white feathery flowers in clusters, perfectly covering the vines. Admired for its grace. 25 to 30 feet. Perennial. **Pkt. 5c; ¼ oz. 25c.**

COBAEA SCANDENS—Elegant, rapid growing climbers, attaining a height of 20 to 30 feet; particularly desirable for covering walls, arbors, etc. **Pkt. 5c; oz. 25c.**

COLEUS—Plants with richly colored foliage of maroon, green, crimson, yellow, etc.; for groups on lawns and ribboning they are indispensable; also valuable for pot culture. 2 to 3 feet high. **Pkt. 50c.**

CONVOLVUS (Morning Glory)—These beautiful annual climbers are of easy culture and produce freely all summer long large funnel-formed flowers of lovely colors. Seed may be sown in the open ground. Height 15 to 20 feet. Mixed colors. **Pkt. 5c; oz. 20c.**

DAHLIAS—These will bloom from seed first year if sown early. Our mixture contains the Cactus, Decorative, Snow and other varieties. **Pkt. 10c; ¼ oz. 50c.**

DIANTHUS, or CHINA PINKS—Most beautiful and satisfactory Summer flowering annuals. Unrivalled for brilliancy and rich variety of color. The plants are bushy, of symmetrical form. 1 foot high. There is a wonderful diversity of colors, from purest white to red shades, deep and intensely brilliant; soft pinks and flesh tints and a large proportion of flowers hieroglyphically marked with various hues, the delicate tints and deep tones mingling in exquisite contrast. **Pkt. 5c; ¼ oz. 25c.**

DIGITALIS (Foxglove)—Very showy, hardy plants. They are easy to grow and produce freely spikes 4 to 5 feet high, well furnished with large Gloxinia-like flowers of various colors. **Pkt. 10c; ¼ oz. 30c.**

GAILLARDIA—Very showy garden annuals. 1 to 2 feet high. Grown in masses, they are especially effective; large flowers, 2 to 3 inches across, producing from early Summer until frost. Unrivalled for cutting. **Pkt. 5c; ¼ oz. 30c.**

GERANIUM—The colors include shades of scarlet and crimson, rose, pink, salmon, cream-veined, pink blush, snowy white, etc. Although perennials, they will produce nice bushy plants and flower the same season if the seed is sown indoors early in the Spring. **Pkt. 10c; ¼ oz. 60c.**

GLOXINIA—Charming pot plants for conservatory, greenhouse or winter garden. They flower in great profusion, having gorgeous colors. 1 foot high. **Pkt. 50c.**

GODETIA—Showy garden annuals, of compact growth, about 1 foot high. Exquisite colors and shades that glisten in the sunlight like satin. **Pkt. 5c; oz. 20c.**



Dianthus, or China Pinks

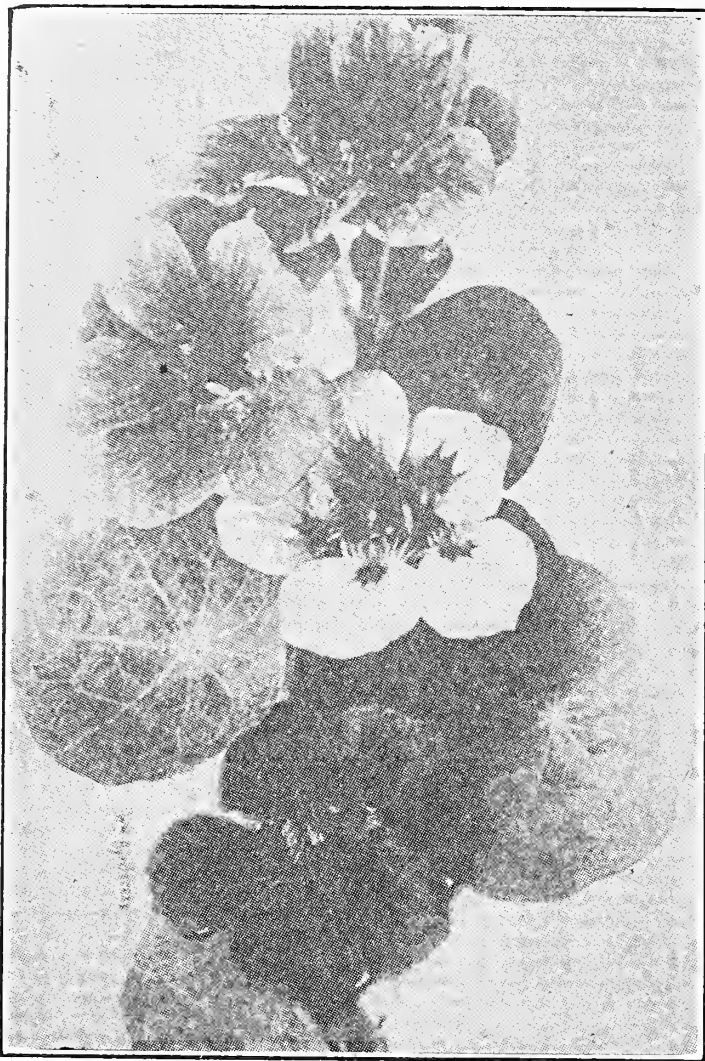

Nasturtium

GOURDS—Ornamental

Favorite annual climbers, of rapid growth, producing odd and interesting fruit.

LOOFA (Dish-Cloth Gourd)—The fibrous interior can be used as a sponge. **Pkt. 5c; oz. 25c.**

DIPPER GOURD—Very well known. **Pkt. 5c; oz. 25c.**

HERCULES CLUB—Green fruit, 2 to 5 feet long. **Pkt. 5c; oz. 25c.**

MOCK ORANGE—Golden orange. **Pkt. 5c; oz. 30c.**

NEST EGG—White egg-like fruit. **Pkt. 5c; oz. 25c.**

Ornamental Mixed—**Pkt. 5c; oz. 25c.**

HOLLYHOCK—A very popular hardy perennial, grown everywhere and valuable for a background. **Pkt. 10c; ¼ oz. 30c.**

HELIOTROPE—Always popular on account of its delightful fragrance. The seed is rather slow in germinating and had best be sown in a box or hotbed. While it is a perennial, it will not stand any frost and is therefore, started afresh each year, unless one cares to remove the plants to the house before frost comes. **Pkt. 10c; ¼ oz. 75c.**

KUDZU VINE—A twining vine of remarkably rapid growth, attaining a length of 40 to 50 feet in one season from established roots. A fine vine for arbors, verandas, etc. Easily grown from seed.

LARKSPUR—The splendid flowers are very large and of various beautiful colors, shades and markings. Height 15 to 18 inches. **Pkt. 5c; ¼ oz. 20c.**

LANTANA—Rapid-growing, tender perennial plants for pot culture in the Winter or garden decorations in the Summer. **Pkt. 5c; ¼ oz. 20c.**

LOBELIA—A beautiful flowering plant, very desirable for pot culture, edgings, hanging baskets, etc., blooming profusely from June to November. **Pkt. 5c; ¼ oz. 20c.**

MARIGOLD (Double African)—Immense flowers, densely double. One of the easiest grown annuals. **Pkt. 5c; ¼ oz. 20c.**

MARIGOLD (Double French)—Mixed colors. **Pkt. 5c; ¼ oz. 20c.**

MARVEL OF PERU, or Four O'Clock—Grows freely from seeds. Blooms from the late afternoon on through the night. Very fragrant. **Pkt. 5c; oz. 25c.**

MAURANDIA—A half-hardy perennial, flowering the first season if sown early. Of rapid growth; blooms profusely throughout the Summer. Slender growing climber. 10 feet high. **Pkt. 10c.**

MIMOSA (Sensitive Plant)—Curious and interesting annuals, with pinkish-white flowers. The leaves close and droop when touched or shaken. **Pkt. 5c; ¼ oz. 20c.**

M O M O R D I C A (Balsam Apple)—Very curious climbing vine, with ornamental foliage; fruit golden yellow, warted, and when ripe opens, showing the seed and its brilliant carmine interior. Annuals. 10 feet high. **Pkt. 5c; ¼ oz. 20c.**

MYOSOTIS (Forget Me Not)—Popular perennials, flowering the first season from early spring-sown seed, or they may be sown in Summer or early Fall, and if bedded out and given protection, like Pansies, they will Winter over and commence flowering in early Spring. **Pkt. 5c; ¼ oz. 20c.**

MIGNONETTE (Sweet-Scented)—A well-known fragrant favorite, and no garden is complete without a bed of Mignonette. **Pkt. 5c; oz. 25c.**

MIGNONETTE (Defiance)—The individual florets are of immense size and deliciously fragrance. **Pkt. 5c; ¼ oz. 25c.**

MIGNONETTE (Golden Machet)—Distinct variety of Machet, with massive spikes of golden yellow blossoms. **Pkt. 5c; ¼ oz. 25c.**

NASTURTIIUM

One of the most popular of all annuals. Easily grown, as they will grow most anywhere except in the shade. Fine for cut flowers. Blooming profusely throughout the Summer, they may be used to cover unsightly railings and to trail over rough ground with fine effect.

Dwarf Mixed—For massing in beds. **Pkt. 5c; oz. 15c.**

Tall Mixed—For climbing on trellises, verandas, etc. **Pkt. 5c; oz. 15c.**

PANSIES

W. D. CO.'S GIANT FLOWERING—We have secured this strain from one of the best growers in the world. For size of bloom, heavy texture and varied shades and colors, with their distinct markings, this strain cannot be excelled. With slight protection, such as meadow hay, leaves or similar material, full-grown plants Winter over in the open ground and commence flowering in early Spring with the Snowdrops and Crocus. **Pkt. 10c; ½ oz. \$1.00.**

PETUNIAS—These are almost indispensable for garden decoration. They flower in a few weeks' time from seed and continue to grow, bud and bloom in luxuriance until frost. The seed we offer include all the Petunia colors. **Pkt 5c; ¼ oz. 30c.**

PORTULACA (Mexican Rose)—Single. Brilliant garden annual, 6 feet high, luxuriating in warm, dry, sunny situations and blooming profusely from early Summer to Autumn. Colors range through innumerable shades of red, yellow, pink, striped, white, etc. **Pkt. 5c; ¼ oz. 15c.**

PORTULACA—Double mixed. Flowers resemble small roses. **Pkt. 10c; ¼ oz. 50c.**

PHLOX DRUMMONDII—For beds and massing nothing can surpass these beautiful annuals. They produce immense trusses of large brilliant flowers of numberless hues throughout the Summer. They are of easy culture, succeeding in all sunny positions. **Pkt. 5c; ¼ oz. 25c.**



W. D. Co.'s Giant Flowering Pansies

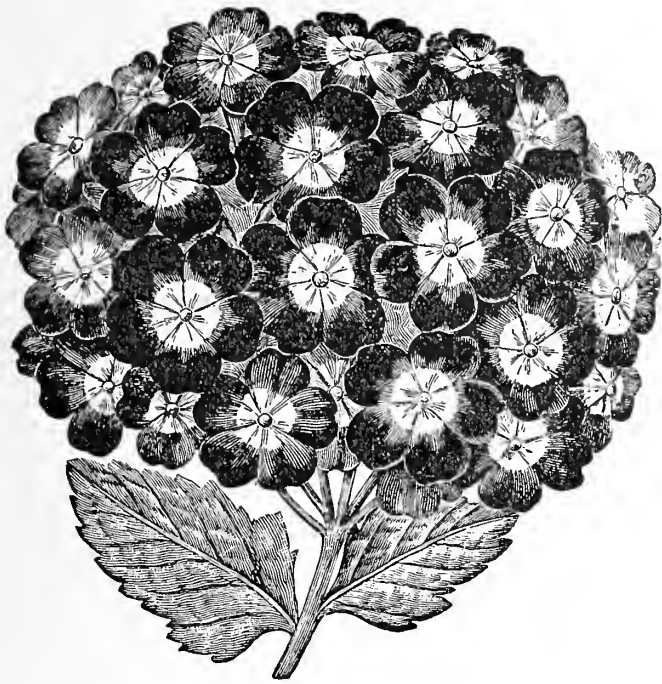

Verbennas

POPPIES—Annual Poppies should be sown as early in the Spring as possible, where they are to remain, as they do not stand transplanting. Sow very thinly, preferably in cloudy weather or after a shower; barely cover the seed; press down firmly. The seed we offer comprise all the Double and Single Poppies, including some of the new varieties. **Pkt. 5c; oz. 25c.**

RICINUS (Castor Oil Bean)

Ornamental plants of stately growth and picturesque foliage, with brilliant colored fruit, producing subtropical effect. Fine for lawns, massing or centre plants for beds.

CAMBODGIENSIS—The main stems and leaf stalks are shining ebony, leaves large, regularly divided and richly colored. **Pkt. 5c; oz. 20c.**

SANGUINEUS—Blood red stalks and clusters of red fruit. 8 feet. **Pkt. 5c; oz. 20c.**

ZANZIBARIENSIS—This is a distinct class. The plants attain great dimensions, leaves are light and dark green and some of coppery bronze. **Pkt. 5c; oz. 20c.**

SCARLET SAGE (Salvia Bonfire)—The plants are of strong, vigorous growth, and while beginning to bloom quite early in the season, will attain a height and breadth of from 3 to 3½ feet when in full flower. Nothing richer and more dazzling in color than this new Salvia has ever been offered. **Pkt. 10c; ½ oz. 50c.**

SCARLET SAGE (Salvia Splendens)—The standard sort; an easy, continuous and persistent bloomer. These scarlet flowers surpass the brightest geraniums in color and quantity of bloom. **Pkt. 5c; ¼ oz. 50c.**

SCARLET RUNNER—Beautiful ornamental climber. **Pkt. 5c; oz. 20c.**

SWEET WILLIAM—There is perhaps no flower more favorably known than the Sweet William. Hardly any garden is considered complete without its planting of Sweet Williams. They are easily grown from seed and produce a wonderful array of color. Perfectly hardy. **Pkt. 5c; oz. 60c.**

SCABIOSA (Mourning Bride)—Perfectly double flowers; useful for cutting; gracefully borne upon long slender stems; range of color from white to rich pink, crimson to deep red, lilac and black, mixed. **Pkt. 5c; ¼ oz. 25c.**

STOCKS (Ten Weeks)—All the varieties are desirable as pot plants as well as in the open garden. They are greatly prized for cut flowers on account of their fragrance and colors. Mixed. **Pkt. 5c; ¼ oz. 50c.**

SMILAX (Myrsiphyllum Asparagoides)—A graceful tuberous-rooted, tender perennial climber, none surpassing it for its glossy deep green, most delicate foliage and small white flowers; fine for vases and baskets. Soak the seed 24 hours before sowing. 6 to 10 feet. **Pkt. 5c. oz. 50c.**

THUNBERGIA (Black-Eyed Susan)—Beautiful, rapid-growing annual climbers, preferring a warm, sunny situation; used extensively in hanging baskets, vases, low fences, etc.; very pretty flowers in buff, white, orange, etc., with dark eyes. 4 feet. **Pkt. 5c; ¼ oz. 25c.**

TORENIA—A splendid annual for vases, hanging baskets, borders, etc.; covered the entire season with a mass of bloom; skyblue with three spots of dark blue, bright yellow centre. **Pkt. 10c.**

VERBENNAS (Mammoth)—Splendid for beds or massing; the trusses and individual flowers are of the largest size, of brilliant colors, free blooming and of vigorous habit. For best and quickest results seed should be sown early in the house or hotbed and transplanted to flowering quarters in May.

Mixed Colors—**Pkt. 5c; ¼ oz. 30c.**

VINCA (Madagascar Periwinkle)—Ornamental free-blooming plants and one of the most satisfactory flowering plants we have. Fine for cut flowers, every bud opening when placed in water.

Alba—White, crimson eye. **Pkt. 5c; ¼ oz. 40c.**

Rosea—Rose, darkeye. **Pkt. 5c; ¼ oz. 40c.**

Mixed Colors—**Pkt. 5c; oz. 30c.**

WALLFLOWER (Single Mixed)—Deliciously fragrant and combine many shades of color, the orange, purple and chocolate predominating. Tender perennial. 1½ feet. **Pkt. 5c; oz. 75c.**

ZINNIAS (Youth and Old Age)—The Zinnia is one of the most brilliant, showy and satisfactory annuals, and has long been a general favorite. **Pkt. 5c; ¼ oz. 25c.**

BOOKS—FLORICULTURE

GREENHOUSE MANAGEMENT. By L. R. Taft. This book forms an almost indispensable companion volume to "Greenhouse Construction." Over 100 excellent illustrations. 210 pages. 5x7 in. Cloth.....**\$1.60**

THE WINDOW FLOWER GARDEN. By Julius J. Heinrich. The author is a practical florist, and this enterprising volume embodies his personal experience in window gardening during a long period. Illustrated. 123 pages. 5x7 in. Cloth.. **.60**



Zinnias.

WISEMAN-DOWNS CO.'S SELECT SWEET PEAS

HOW TO GROW SWEET PEAS

The soil for Sweet Peas should be rich and deep. A good rich loam, with plenty of well-rotted manure in it, is the ideal soil for raising good plants that will produce plenty of blooms. Seed should be sown as early in the season as the ground can be worked, which is usually between the middle of March and the middle of April in the latitude of Baltimore. It is best to dig a trench about 6 inches deep, in the bottom of which sow the seed. Cover with about an inch of soil, pressing it down firmly. As soon as they are above the ground thin out to 2 to 4 inches apart. They should be staked up with brush or wire about 4 feet high. During dry weather water frequently.

AGNES ECKFORD—Very light pink, self-color. One of the most delicate shades of pink; medium large, hooded form.

AMERICA—Large size, open form. Very bright and effective and holds its color well. It is the brightest striped variety we have.

AURORA—Orange rose, striped on white. Extremely attractive.

BLACK KNIGHT—Deep claret. One of the darkest varieties.

BLANCHE BURPEE—Pure white, very large, graceful; hooded form.

BLANCHE FERRY—Pink and white; medium size, open form.

CAPTAIN OF THE BLUES—Almost true blue. It changes after opening to a bluish purple.

DUKE OF SUTHERLAND—Standard, of a deep claret with strong reddish tinge, deepening to a rich purple; wings of deep violet purple.

DOROTHY ECKFORD—One of the best pure white varieties; is semi-hooded, of the best form, with large wings and very large standard, which averages 2 inches across; is similar in effect to Blanche Burpee, but is full one-half larger.

EXTRA-EARLY BLANCHE FERRY—One of the earliest Sweet Peas in cultivation; of the greatest value

for cut flowers, being a dwarfer, and more prolific bloomer than the original Blanche Ferry; color deep rose pink, wings white.

HENRY ECKFORD—Almost a clear orange self. The nearest approach to orange-yellow in Sweet Peas, and a beautiful color.

KATHERINE TRACY—Brights of pink. A ver vigorous grower.

KING EDWARD VII—The very best rich, dark red sort.

LOVELY—Shell pink; usually 4 blossoms to the stem.

MAID OF HONOR—White, edged with lavender; hooded form.

MRS. JOSEPH CHAMBERLAIN—White, striped rose. Very large.

NAVY BLUE—One of the best; medium size, semi-hooded form.

PRIMA DONNA—A pure pink, very large. The vine is a vigorous grower; usually 4 blossoms to the stem.

QUEEN ALEXANDRA—This is an intense scarlet self of grand texture—a bold expanded flower of finest form. It is very free flowering and

the flowers are of giant size with long, strong stems.

SENATOR—Chocolate stripes on white ground. Large size.

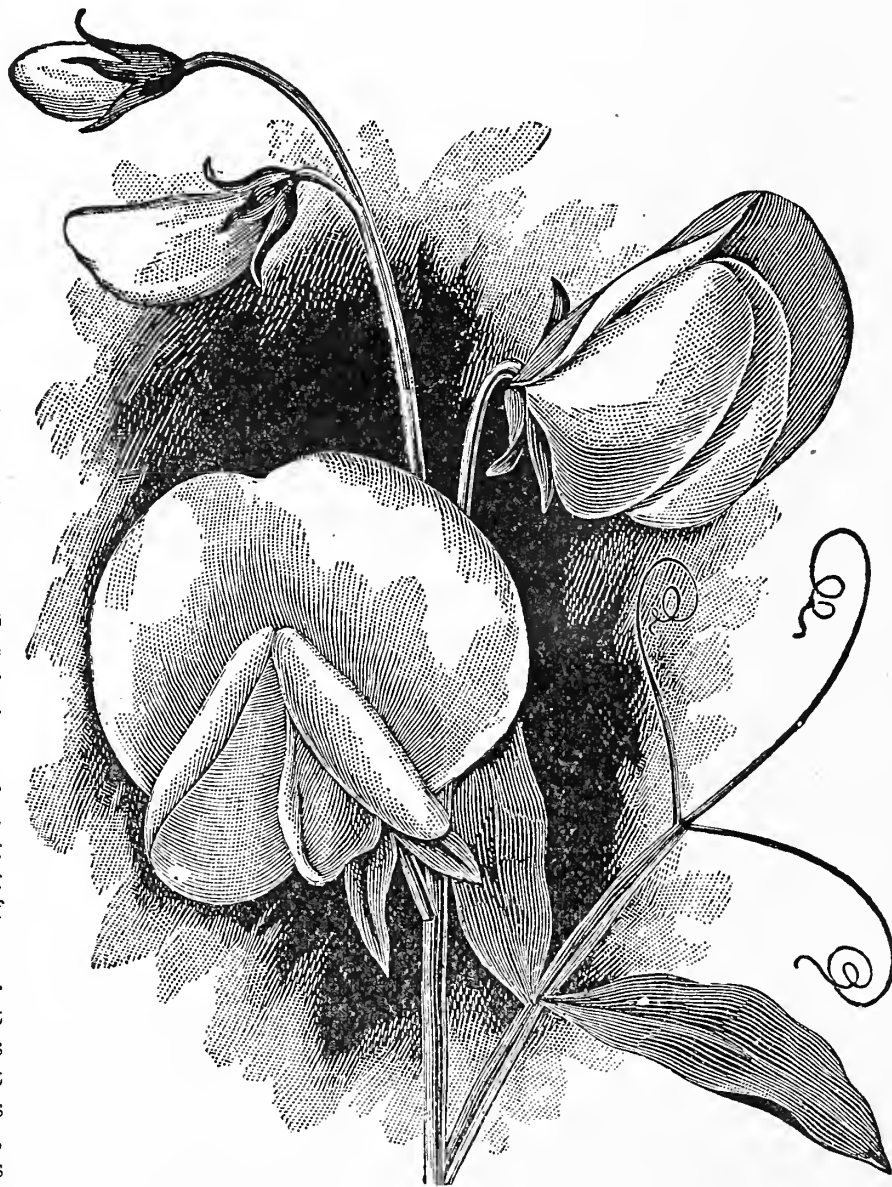

ANY OF THE ABOVE—PRICE: Pkts. 5c and 10c; oz. 15c; ¼ lb. 35c; lb. \$1.25.

WISEMAN-DOWNS CO.'S SPECIAL MIXTURE—This unsurpassable mixture of Sweet Peas is a studied formula, containing correct proportions of various bright colors and shades, supplying a harmony of brilliancy. Pkts. 5c and 10c; oz. 15c; ¼ lb. 30c; lb. \$1.00.

Best by Every Test

ORCHID-FLOWERED SWEET PEAS

AGRICOLA—Extra large, very wavy flowers of a light lilac or lavender-pink.

BARBARA—Beautiful rich orange-salmon.

BLANCHE FERRY SPENCER—Identical in color to the popular pink and white Blanche Ferry; immense wavy flowers.

BLUE PICOTEE—The best Picotee, edged blue on white.

COUNTESS SPENCER—A beautiful clear pink, shaded darker on edges.

DOBBIE'S CREAM—Deep cream, or primrose-yellow.

EDWARD COWDY—Orange-scarlet.

FLORENCE NIGHTINGALE—Very fine pure lavender.

ILLUMINATOR—Rich salmon-pink.

KING WHITE—Very large pure white flowers.

MRS. CUTHBERTSON—Standard rose pink, wings bluish white.

OTHELLO SPENCER—Beautifully waved flowers of a rich deep maroon.

ROSABELLE—A magnificent large and bright rose.

THOMAS STEVENSON—Brilliant orange-scarlet.

PRICE ON ANY OF ABOVE—Pkt. 10c; oz. 25c; ¼ lb. 50c.

SPENCER EXTRA-FINE MIXED—All sorts. Pkts. 5c and 10c; oz. 20c; ¼ lb. 50c.

CANNAS—Large Flowering

For a brilliant show all Summer there is no plant excelling the Canna. It even surpasses the Geranium in its gorgeous display of brilliant colors, blooming continuously from the time of planting until cut down by frost. As Cannas are good pot plants either for Summer or Winter flowering, they may be lifted and potted in the Fall before the approach of frost. Grown in this way, they are ready to continue their good work without disturbing the plants.

AUSTRIA—Enormous flowers, beautiful canary yellow with a silvery hue inside slightly dotted with red. Both in foliage and flower this Canna surpasses all others. **2 for 25c; \$1.50 dozen.**

FLORENCE VAUGHAN—It still remains the highest type of new French Canna flowers. The flowers are a rich golden yellow, thickly dotted with brightest red. Height 5 feet. No Canna bed is complete without this perfect ever bloomer. **2 for 25c; \$1.50 dozen.**

EGAN DALE—Beautiful cherry-red flowers surmount the vigorous dark brown foliage. **2 for 25c; \$1.50 dozen.**

BURBANK—Giant yellow flowers, like an orchid; 15 to 20 spikes on a plant. **2 for 25c; \$1.50 dozen.**

CHARLES HENDERSON—Height, 4 feet; color brilliant deep crimson; broad deep green foliage, narrowly margined with bronze. Vigorous grower. **2 for 25c; \$1.50 dozen.**

FLORENCE VAUGHAN—This is the best yellow Canna spotted with red dots. The yellow is intense, and the dots, not too pronounced, add to the beauty of the flowers without detracting from the golden mass. 4 feet. **2 for 25c; \$1.50 dozen.**

GENERAL MARKEL—One of the earliest and freest flowering varieties, holding its flowers well above the foliage; in color a brilliant scarlet, suffused with orange, the base and edge of pedals marbled golden yellow. 4 feet. **2 for 25c; \$1.50 dozen.**

KING HUMBERT—In this grand Canna we have a combination of the highest type of flowers with the finest bronze foliage. Its flowers measure 6 inches in diameter, produced in gigantic trusses; a brilliant orange-scarlet with bright red markings; foliage broad and massive, of a rich coppery bronze. Height 5 feet. **25c each; \$2.25 dozen.**

METEOR—Magnificent bedding variety with massive erect trusses of deep blood-red flowers, produced with a freedom that leaves nothing to be desired. 5 feet. **2 for 25c; \$1.50 dozen.**

PAUL MARQUANT—Immense flowers, in bold, shapeless trusses; shimmering salmon-rose, with silvery lustre of many changeable tints. **2 for 25c; \$1.50 dozen.**

PHILADELPHIA—An ideal bedding variety of medium height; a healthy, vigorous grower, with handsome foliage and a continuous bloomer; color a bright scarlet-crimson, very rich and velvety. **2 for 25c; \$1.50 dozen.**

SOUVENIR DE MME. CROZY—Five feet; green foliage; extra-strong grower. The flower spikes, of which there are 5 to 6 on a stalk, are very large and full. Garnet-red flowers, with broad border and large center of a brilliant yellow. **2 for 25c; \$1.50 dozen.**

SOUVENIR D'ANTOINE CROZY—Four feet; green foliage. This is a perfect gem and, in our estimation, the finest gold-bordered variety. The flowers are large, well-rounded petals, which are of the intense scarlet-crimson, rich and dazzling, and are bordered with a broad, rich golden-yellow border. **2 for 25c; \$1.50 dozen.**

BEAUTE POITEVINE—Three and a half feet. This proved one of the best Cannas in our collection last Summer. It is of a bright, rich crimson color, with erect flower spikes. It seems to stand severe droughts better than most kinds, the flowers standing up during the hottest Summer days without injury. It comes into bloom very early and blooms continuously. **10c each; 2 for 25c; \$1.50 dozen.**

ALPHONSE BOUVIER—Its every shoot is topped by enormous trusses of vivid crimson-scarlet flowers a single plant sometimes showing 30 or 40 at one time. **2 for 25c; \$1.50 dozen.**

ALSACE—Pure white; grows from 4 to 6 feet; clear green foliage; produces from 12 to 18 shoots from a single eye. The only white Canna in existence. **2 for 25c; \$1.50 dozen.**

ROBUSTA—One of the most effective of all dark-leaved varieties; valuable on account of its luxuriant dark bronze foliage. 6 to 8 feet. **2 for 25c; \$1.50 dozen.**

The above are all started plants. Ready in April and May.

DRY ROOTS—50c. dozen.

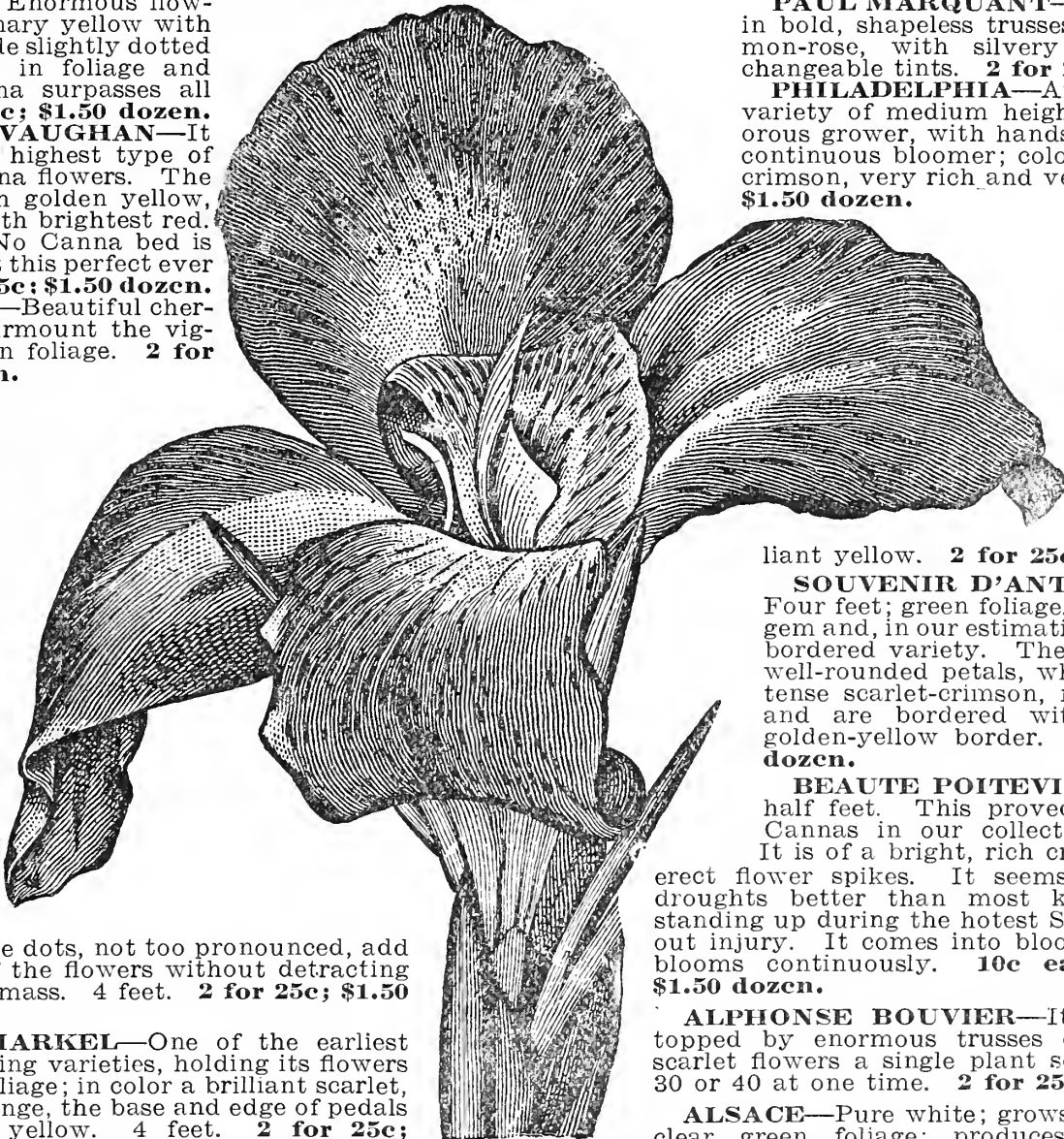

DAHLIA ROOTS—Field Grown

All of the Dahlias offered in this list are supplied in dormant field roots, or strong divisions of proper planting sizes. Order Dahlia Roots early. Some customers wait too long before ordering and are apt to be disappointed, owing to stocks of some varieties being exhausted.

A. D. LIVONI (Show)—A handsome clear pink, beautifully quilled, or perfect form and very free flowering. **25c each; \$2.25 dozen.**

ARABELLA (Show)—Soft primrose-yellow, shaded peach blossom on edges. **20c each; \$1.75 dozen.**

DELICE (Decorative)—The most popular pink variety. Its beautiful soft yet lively color, a glowing rose-pink, together with its perfect shape, makes this one of the best for cutting or decorative sorts in the garden. **25c each; \$2.25 dozen.**

GENERAL BULLER (Cactus)—A bright scarlet, clear and intense. **25c each; \$2.25 dozen.**

QUEEN WILHELMINA (Peony Flowered)—Pure white, golden centre. **25c each; \$2.25 dozen.**

WM. AGNEW (Decorative)—Rich, dazzling carmine-red. **15c each; \$1.50 dozen.**

RENE CAYEUX (Cactus)—One of the best free blooming Dahlias. Begins to flower early and continues in such profusion that at times the foliage is almost hidden with flowers. Color a soft Geranium red shaded crimson. **20c each; \$1.75 dozen.**

KRIEMHILDE (Cactus)—The color is a delicate shell pink. The broad center petals are white forming a beautiful rosette of that color above the pink. **20c each; \$1.75 dozen.**

C. W. BRUTON (Decorative)—Rich canary yellow. A magnificent flower for either cut or decorative purposes. **20c each; \$1.75 dozen.**

JACK ROSE (Decorative)—A brilliant crimson-red with fiery tones in the center of the flower, the whole overlaid with a soft violet-maroon. **15c each; \$1.50 dozen.**

GRAND DUKE ALEXIS (Show)—Color pure soft white, the tips of the petals edged and suffused with delicate pink. The finest of the type. **25c each; \$2.25 dozen.**

MISS BROWNING (Snow)—A perfectly formed flower, canary yellow, sometimes showing a white tip. **25c each; \$2.25 dozen.**

VOLKER (Cactus)—Clear lemon yellow. The best in its color. **25c each; \$2.25 dozen.**

PERLE DE LYON (Decorative)—A most valuable white decorative Dahlia, and one of the best whites of any class for cut-flower purposes. Its flowers are of good size and held erect on long, stiff, wiry stems. **25c each; \$2.25 dozen.**

MONT BLANC (Decorative)—An early free flowering creamy white, on good stiff stems. A most important cut-flower variety. **25c each; \$2.25 dozen.**

AMBER QUEEN (Pompon)—Rich, clear amber, shaded apricot. **20c each; \$1.75 dozen.**

SNOWCLAD (Pompon)—A fine pure white. **20c each; \$1.75 dozen.**

PRINCESS VICTORIA (Show)—Primrose yellow; never produces an imperfect flower; in bloom early and late. **20c each; \$1.75 dozen.**

GOLDEN GATE (Cactus)—A unique and charming variety of the true Cactus type. The color is pure golden yellow shading to old gold. **40c each.**

QUEEN OF THE YELLOW (Show)—A beautiful profuse, clear yellow. **25c each; \$2.25 dozen.**

WARE'S MARS (Pompon)—Beautiful deep red, of fine form. **10c each; \$1.00 dozen.**

GERMANIA (Peony Flowered)—The color is an extremely soft rich strawberry red. The flower is large and graceful, with full, loose petals. **15c each; \$1.50 dozen.**

ORANGE KING (Decorative)—Very rich, glowing orange-scarlet. **20c each; \$1.75 dozen.**

DOROTHY PEACOCK (Show)—A beautiful soft pink, shading slightly darker on the outer petals as the flower expands. Strong, vigorous, with-



Dahlia

out any indication of weakness or disease, each plant being sturdy and vigorous. **20c each; \$1.75 dozen.**

ELSE (Cactus)—Buttercup yellow at the base, gradually shading to amber, the edges of the petals finished with bright rose. **20c each; \$1.75 dozen.**

CANDEUR (Cactus)—A wonderful pure white, which in the fully developed flower more closely resembles an incurred Chrysanthemum than any other sort; a valuable cut flower. **25c each; \$2.25 dozen.**

Double Pompon Dahlias

While the Pompon varieties are not as extensively grown as the other double types they still have many admirers; their dainty little flowers are produced very freely.

ANNIE DONCASTER—Light yellow, base suffused with pearly pink.

ARTHUR KERLEY—Purplish crimson, very free.

BOBBY—Plum color. One of the best.

CATHERINE—Well-formed primrose yellow.

DARKNESS—Deep velvety-maroon.

FASCINATION—Pink and lavender blotched white.

HELENE LAMBERT—A splendid free-flowering yellow of perfect shape.

INDIAN CHIEF—Crimson, very free.

KLEINE DOMITEA—Orange buff, always in flower.

LITTLE BESSIE—Creamy-white, closely quilled.

PRINCE CHARMING—Cream, heavily tipped purple.

SALAMANDER—Gold yellow, tipped orange red.

SUNBEAM—A fine crimson.

Price: Any of the above, 20 cts. each; \$2.00 per doz.

Best by Every Test

DOUBLE PEARL TUBEROSES

One of the most fragrant and beautiful of the Summer flowering bulbs. By skillful management a succession of flowers may be obtained all the year round. For early flowers they can be started in February or March in the greenhouse or hotbed, and for a succession they can be planted at intervals as late as July. For flowering in the open border plant about the middle of May, or as soon as the ground becomes warm. **Each, 5c; dozen, 50c.**

GLADIOLUS

AMERICA—One of the best for cutting or bedding; color a beautiful shell pink; orchid-like in its colorings and textures. **Each, 5c; dozen, 50c.**

AUGUSTA—A lovely and useful variety; pure white with blue anthers. **Each, 5c; dozen, 50c.**

BRILLIANT—Glowing orange-scarlet with carmine and white throat. **Each, 10c; dozen, \$1.00.**

FIRE KING—Large flowers of vivid scarlet with garnet throat blotch on lower petals. **Each, 10c; dozen, \$1.00.**

FLAMBEAU—Immense flowers of vivid orange-scarlet with throat blotch of white, shaded and marked with Tyrian Lake on the lower petals. **Each, 40c; dozen, \$4.00.**

GLORY—Large round flowers, the edges of the petals being daintily frilled or ruffled. The coloring is creamy blush, lightly tinted carmine-rose; throat yellowish overlaid with purplish-carmine blotches on lower petals. **Each, 5c; dozen, 50c.**

NIAGARA—A splendid variety for cut flowers; color a delicate creamy yellow, lightly marked and splashed with rosy carmine in the throat. **Each, 10c; dozen, \$1.00.**

KLONDIKE—Clear yellow with crimson-maroon blotch in the throat. **Each, 5c; dozen, 50c.**

PEACE—Beautiful large flowers, white with claret blotch on lower petals and pale featherings. **Each, 10c; dozen, \$1.00.**

SCRIBE—A giant-flowering, soft rose blazed with carmine; very large, open flowers and enormous spike. **Each, 10c; dozen, \$1.00.**

SHAKESPEARE—White, suffused with carmine-rose; large rose blotch. **Each, 10c; dozen, \$1.00.**

SULPHUR KING—A beautiful clear yellow, with long spikes. **Each, 20c; dozen, \$2.00.**

MIXTURES OF GLADIOLI

	Dozen.	100.
Chilosii —All colors mixed	\$0.50	\$4.00
Lemoine's Mixture40	3.00
W. D. Co.'s Choice Mixed50	4.00

CALADIUM ESCULENTUM (Elephant's Ear)

Mammoth Bulbs—10 to 12 inches in circum. **.25c each; \$2.50 dozen**
First Size Bulbs—8 to 11 inches in circum. **.20c each; \$2.00 dozen**
Second Size Bulbs—7 to 9 inches in circum. **.15c each; \$1.75 dozen**
Third Size Bulbs—5 to 7 inches in circum. **.10c each; \$1.00 dozen**

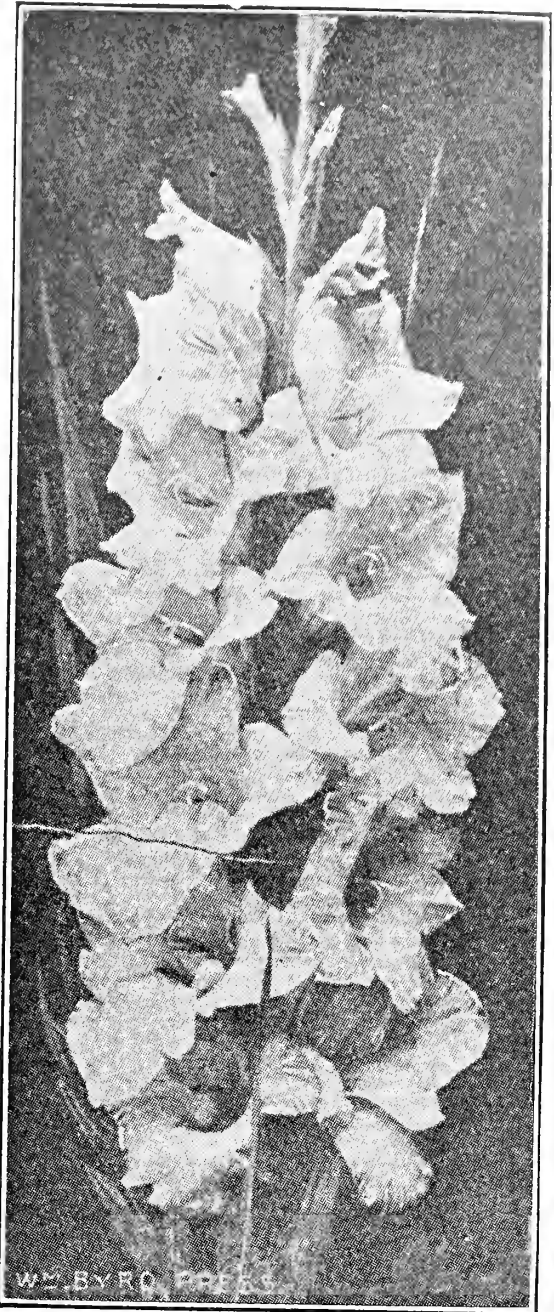

Gladiolus

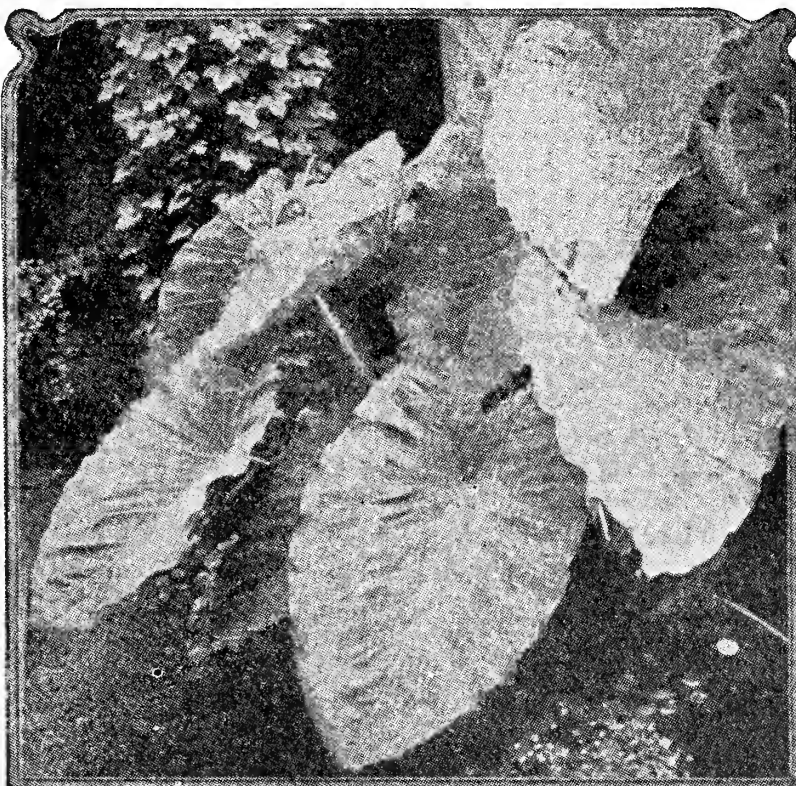

Caladium Esculentum (Elephant Ears)

We can supply, in season, other roots and plants as follows: Hydrangea, Palms, Petunias, Roses, including all sorts such as Hybrid-Tea, Hybrid-Perpetual, Memorial, or Evergreen, Ramblers, etc., Alyssum, Bellis Perennis, Campanulas, Carnations, Centaurea, Chrysanthemums, Coreopsis, Delphiniums, Digitalis, Ferns, Geraniums, Hollyhocks, Peonies, Phlox, Salvia, Sweet William, Tritoma, Clematis, Honey-suckles, Hardy English Ivy, Hardy Jasmine, Wistarias, etc.

Will be pleased to quote prices on any of the above on application.

NURSERY DEPARTMENT

APPLES

SUMMER

- BENONI**—Yellow, nearly covered with red; juicy.
- EARLY HARVEST**—Medium; pale yellow; tender, juicy.
- GOLDEN SWEET**—Large; pale yellow; very sweet.
- KESWICK CODLIN**—Large; yellow; fine for cooking.
- MAXSON'S EARLY**—Strong grower, with healthy foliage; hardy; excellent bearer. In shape and appearance fruit is like Sweet Bough, but the flesh is tart, acid, good flavor and cooks perfectly tender.
- RED ASTRACHAN**—Large; beautiful deep crimson.
- SOPS OF WINE**—Medium; dark crimson.
- SWEET BOUGH**—Large; pale yellow; tender, sweet.

WINTER

- BALDWIN**—Large; bright red; juicy, crisp, sub-acid. One of the most popular Winter Apples. January to April.
- BEN DAVIS**—A leading commercial variety. Tree hardy, healthy, vigorous. Fruit large, handsomely colored, attractive. At its best in Virginia, Kentucky, Tennessee, Illinois, Missouri, Arkansas and portions of adjoining States. January to June.
- FALLAWATER**—Very large, globular; yellowish-green, dull red cheek; juicy, crisp, pleasant sub-acid flavor. December.
- GOLDEN RUSSET**—Vigorous growth; medium; russet; crisp, juicy, mild sub-acid; hardy; very good; long keeper. Ripening November to April.
- GRIMES' GOLDEN**—Medium to large, cylindrical; golden yellow, sprinkled with gray dots; flesh crisp, tender, juicy, sprightly. Very good to best. Tree hardy, vigorous, productive, bears early. January to April.

Prices on above:	Each.	Doz.
3 to 4 feet.....	\$0.50	\$5.00
5 to 7 feet.....	.75	7.00

AUTUMN

- AUTUMN STRAWBERRY**—Tender, juicy, productive.
- DUTCHESS OF OLDENBURG**—Good size; yellow, streaked red; juicy, rich, sub-acid, productive.
- FALL PIPPIN**—Large; yellow; rich, aromatic.
- GRAVENSTEIN**—Large; striped; fine quality; one of the best Fall sorts.
- HAAS (Fall Queen)**—Large; striped; vigorous and productive.
- MAIDEN'S BLUSH**—Large, beautiful, blush cheek.
- MUNSON SWEET**—Good size; yellow, red cheek.
- RAMBO**—Medium; yellow, streaked red.
- RED BIETIGHEIMER**—Large; yellow, shaded red; flesh white, juicy, with a brisk sub-acid flavor.
- WESTERN BEAUTY**—Large; shaded bright red on plae yellow; crisp, tender, mild, sub-acid.

CRAB APPLES

- EXCELSIOR**—Tree a strong grower, hardy and healthy. Fruit large for a Crab Apple and very attractive; flavor agreeable.
 - HYSLOP**—Almost as large as Early Strawberry; apple deep crimson; very popular on account of its large size, beauty and hardiness. Vigorous. October to January.
 - MARTHA**—A new variety; a seedling of the Dutchess of Oldenburg. Resembles the Transcendent, but larger; beautiful showy fruit and bears enormously. All things considered, we doubt if it has an equal among the Crabs. Vigorous. September and October.
 - TRANSCENDENT**—Skin yellow, striped with red; flesh crisp and juicy. An early and heavy bearer. One of the best known varieties. Vigorous. September and October.
 - WHITNEY**—Large; glossy green, striped, splashed with carmine; flesh firm, juicy, and flavor very pleasant; ripe latter part of August. Tree a great bearer and very hardy; a vigorous grower, with a dark green, glossy foliage. Vigorous. August.
- Price**.....Each, 50c. Dozen, \$5.00

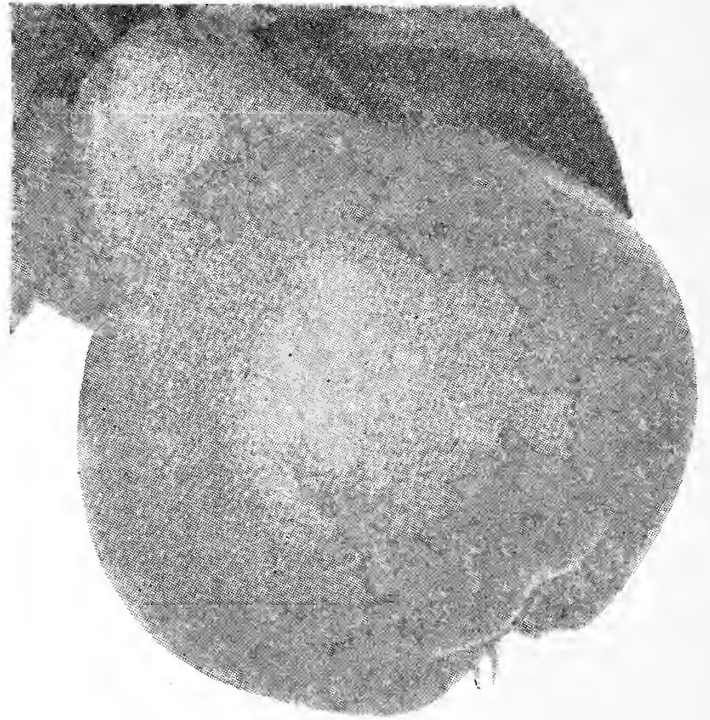

PEARS

Our Pear Trees are grown on heavy clay soil, especially well adapted to the production of strong, vigorous stock. No better trees can be grown.

- BARTLETT**—Large; buttery, juicy, high flavored; great bearer; very popular. August and September.
- FLEMISH BEAUTY**—Large; juicy, melting, rich and fine; good bearer; hardy everywhere. Vigorous. September and October.

WORDEN SECKEL—A seedling of Seckel. Fruit medium size, borne in clusters; juicy, buttery, fine-grained, with a flavor and aroma fully equal to that of its parent, which it surpasses in size, beauty and keeping qualities. Ripens in October, but will keep in good condition till December.

KOONCE—Medium to large, handsome; yellow; flesh juicy, sweet, spicy, good. Ripens with the earliest. Tree a strong grower, hardy and productive. August.

KEIFFER—Its large size, handsome appearance and remarkable keeping and shipping qualities make it exceedingly profitable for market. October and November.

Price Pear Trees:	Each.	Doz.
3 to 4 feet.....	\$0.50	\$5.00
4 to 5 feet.....	.75	7.00

PEACHES

Trees are all grown free from insects, perfectly healthy, well-ripened wood, with splendid roots, all stored in frost-proof cellars beyond injury during the Winter.

Owing to a magnificent growing season, our Peach Trees have made up largely to the 4 to 6 feet grade; fine well-developed trees. The smaller grades and mail size will be scarce stock in many varieties.

Will be pleased to quote prices on large lots on receipt of list. Those desiring trees for orchard planting should place orders early.

Ad. Dewey, Alexander, Banner, Barnards, Beer's Smock, Belle, Capt. Ede, Carman, Chairs Choice, Champion, Crawford's Early, Crawford's Late, Crosby, Elberts, Engles' Mammoth, Fitzgerald, Foster, Globe, Gold Drop, Greensboro, Heath Cling, Hills' Chili, Kalamazoo, Lemon Free, Lewis, Marshalls, Matthew's Beauty, Mayflower, Mountain Rose, Niagara, Old Mixon Free, Prolific, Reeve's, Salway, Sneed, Stephen's, Stump, Triumph, Wheatland, William's Favorite, Wonderful and Yellow St. John—50c each; \$3.50 per dozen.

PLUMS

BURBANK—The best and most profitable among growers for market; ripens 10 to 14 days after Abundance. Tree hardy, sprawling, vigorous grower, unequaled in productiveness; bears young. Fruit large, excellent quality; cherry red with lilac bloom. August. **50c each; \$3.50 dozen.**

ABUNDANCE—(Botan.)—One of the oldest and best known Japanese varieties; hardy and productive. Fruit large, lemon yellow, with heavy bloom; good quality. August. **50c each; \$3.50 dozen.**

SHROPSHIRE DAMSON—Medium; dark purple; very productive; best for preserving. October. **50c each; \$3.50 dozen.**

MAYNARD—(H.) A sturdy, strong and very rapid grower with heavy, luxuriant foliage. It fruits heavily every year, not overhanging, but yielding a full satisfactory crop, bearing its burden of fruit on the inside of the tree. Fruit is very large, nearly round; color deep, dull red, thin whitish bloom. Flesh firm, melting and juicy, rich and sweet; extra fine quality. Its shipping qualities are unsurpassed. **50c each; \$3.50 dozen.**

QUINCES

Price of Quince Trees:	Each.	Per 10
Angers, 4 to 5 feet.....	\$0.50	\$5.00
Angers, 3 to 4 feet.....	.50	5.00
Champion and Bourgeat, 4 to 5 feet.	.60	6.00
Champion and Bourgeat, 3 to 4 feet.	.50	5.00
Rea and Orange, 4 to 5 feet.....	.75	6.50
Rea and Orange, 3 to 4 feet.....	.75	6.00

BOURGEAT—The strongest grower, fruiting at 3 and 4 years in nursery rows. Fruit of largest size, round; rich, golden color, smooth; very tender when cooked. **50c each; 4 for \$1.50.**

ORANGE—Fruit large, bright yellow, of excellent flavor. **50c each; 3 for \$1.50.**

REA—A seedling of the Orange, averaging much larger. **50c each; 3 for \$1.00.**

MULBERRIES

Price of Mulberry Plants:	Each.	Per 10
New American and Downing, 4 to 5 feet.	\$0.60	\$5.00
New American and Downing, 5 to 6 feet.	.75	6.00
Russian and White, 4 to 6 feet.....	.30	2.50
Russian and White, 3 to 4 feet.....	.20	1.50
Black English, 4 to 6 feet.....	.40	3.50
Black English, 3 to 4 feet.....	.30	2.50

NEW AMERICAN—Equal to Downing's in all respects and much hardier. Vigorous grower, very productive; the best variety for fruit; ripe from middle June to middle September. **35c each; 3 for \$1.00.**

DOWNING'S EVERBEARING—Very large, black, handsome, sweet, rich and excellent. **35c each; 3 for \$1.00.**

RASPBERRIES

	Per Doz.	Per 100
Guthbert.....	\$0.75	\$3.75
Gregg.....	1.00	5.00
Miller Red.....	.75	5.00
St. Regis.....	1.25	9.00

CHERRIES

HEART and BIGARREAU

BLACK TARTARIAN—Very large; bright purplish black; half-tender, juicy, very rich, excellent flavor; productive. First to middle of July.

GOV. WOOD—One of the best Cherries; very large; light yellow, marbled with red; juicy, rich and delicious. Tree healthy and a large bearer. Hangs well on the tree. Vigorous. Last of June.

NAPOLEON BIGARREAU—Very large; pale yellow or red; very firm, juicy and sweet; very productive; one of the best. Vigorous. First of July.

WINDSOR—Fruit large; liver colored, resembling the Elkhorn, ripening a few days after that variety; flesh remarkably firm, of fine quality. Tree hardy and prolific. Vigorous. Middle of July.

YELLOW SPANISH—Large; pale yellow, with red cheek; firm, juicy and excellent; one of the best light-colored cherries; productive. Last of June.

DUKE and MORELLO

EARLY RICHMOND—Medium size; dark red; melting, juicy, sprightly, acid flavor. This is one of the most valuable and popular of the acid cherries; is unsurpassed for cooking purposes, and is exceedingly productive. June.

ENGLISH MORELLO—Medium to large; blackish red; rich, acid, juicy and good; very productive. Moderate. August.

MAY DUKE—Large; dark red; juicy and rich; an old, excellent variety; productive. Middle of June.

MONTMORENCY—A large red, acid cherry, larger than early Richmond and fully 10 days later. Very profitable. Early Richmond hangs in clusters and is more liable to rot. Last of June.

Price Cherries.....Each, 75c. Dozen, \$4.75

STRAWBERRIES

Strawberries will succeed in any soil that is adapted to ordinary farm or garden crops. Soil should be thoroughly prepared to a good depth, well drained and enriched. Vegetable manure (muck, rotten turf, wood soil, ashes, etc.) is the best. For field culture, set in rows 3 to 3½ feet apart, 15 to 18 inches in rows; for garden, 15 inches apart each way, leaving pathway every third row. To produce fine, large fruit, keep in hills, pinching runners off as soon as they appear. Ground should always be kept clean and well cultivated. In Winter a covering of leaves, straw or some kind of litter will protect the plants. Do not cover them until ground is frozen or so deep as to smother the plants, and remove covering before growth starts in Spring. Mulching will keep the fruit clean and the soil in good condition through the fruiting season.

NICK OHMER—Very large and stocky, sending out plenty of very strong runners, probably not surpassed in healthy, vigorous growth and productiveness by any variety. The fruit is of the largest size, never misshapen. Its only departure from the regular roundish conical form is when, under high culture, it is somewhat triangular. It is dark, glossy red, firm and of excellent flavor.

BRANDYWINE—A fine, large, late, handsome, productive berry of excellent quality; regular conical form; dark, glossy red, extending to the center. Plant healthy and vigorous; abundant producer. An extra-good sort for all purposes.

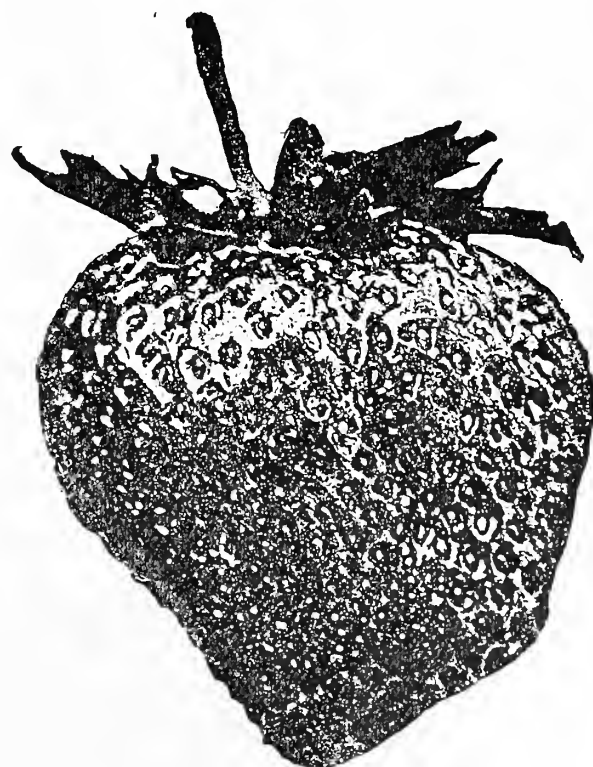

Brandywine Strawberry.

WM. BELT—A large, handsome, productive berry for market or home use. Vigorous, thrifty, heavy plant, producing large crops under good common matted row culture. Berries extra large, conical, quite uniform in shape, brilliant glossy red; ripens all over without green tips; good quality; carries well to market and brings highest price. One of the best varieties.

HAVERLAND—(P.)—A fine grower, very productive. One of the leading early market sorts. Berries bright red, large, long, uniform; medium size and quality.

GANDY—A reliable late variety; berries bright crimson, very uniform in size and shape, large and firm; plants vigorous and healthy.

SENATOR DUNLAP—Very productive; large, bright, or slightly dark red. Quality the very best.

GLEN MARY—A fine, large, late berry of excellent quality.

STEVENS' LATE CHAMPION—Large, light red berries, pointed globular; regular and perfect in form; very firm and of extra-high quality. An ideal plant to produce large berries and yield an enormous crop.

Price any above layer plants:
Per 100.....\$1.50 Per 1,000.....\$12.00

BLACKBERRIES

We handle no suckers, offering only strong, vigorous, heavily rooted plants, grown from root cuttings.

Prices of Blackberries:	Each.	Per 10	Per 100
Snyder, Taylor's Prolific, Kit-tatinny, Wilson's.....	\$0.15	\$0.80	\$2.25
Ancient Briton, Eldorado and Ward.....	.15	1.00	2.75
Blowers.....	.20	1.50	3.00
Mersereau.....	.15	1.00	2.75
Ohmer.....	.15	1.00	2.00
Lucretia Dewberries.....	.15	.18

GRAPES

Price of Grape Vines:	Each.	Per 10	Per 100
Agawam, 1 year.....	\$0.10	\$0.60	\$5.00
Agawam, 2 years.....	.15	.80	6.00
Brighton, 1 year.....	.10	.60	6.00
Brighton, 2 years.....	.15	.80	7.00
Campbell's Early, 1 year.....	.15	1.00	8.00
Campbell's Early, 2 years.....	.20	1.50	11.00
Catawba, 1 year.....	.10	.50	4.00
Catawba, 2 years.....	.15	.60	5.00
Champion, 1 year.....	.10	.60	5.00
Champion, 2 years.....	.15	.80	6.00
Concord, 1 year.....	.10	.50	3.50
Concord, 2 years.....	.10	.60	4.50
Delaware, 1 year.....	.10	.60	5.00
Delaware, 2 years.....	.15	.80	6.00
Diamond, 1 year.....	.10	.60	6.00
Diamond, 2 years.....	.15	.80	7.00
Green Mountain, 1 year.....	.20	1.50
Green Mountain, 2 years.....	.25	2.00
Ives, 1 year.....	.10	.60	5.00
Ives, 2 years.....	.15	.80	6.00

APRICOTS and NECTARINES

ALL LEADING VARIETIES.
Each, 50c. Dozen, \$6.00.

GOOSEBERRIES

DOWNING—Large, handsome, pale green and of splendid quality for both cooking and table use; bush a vigorous grower, and usually free from mildew. 25c each; \$2.00 dozen.

HOUGHTON'S—Small to medium, roundish, oval; pale red; sweet, tender; very good; plants spreading; shoots slender, enormously productive. 25c each; \$2.00 dozen.

INDUSTRY—Berries of largest size, excellent flavor, pleasant and rich; dark red color when fully ripe. Strong upright grower; an immense cropper, less subject to mildew than most of the foreign varieties. The best known and most successful English sort. 30c Each; \$3.00 dozen.

CURRANTS

FAY'S PROLIFIC—The leading market variety. Extra-large stems and berries, uniform in size; easily picked; exceedingly productive. No variety ever made as quick a jump into popular favor, the demand most seasons being in excess of the supply. 20c each; \$1.75 dozen.

CHERRY—Berries sometimes more than half an inch in diameter; bunches short; vigorous and productive when grown on good soils and well cultivated. 20c each; \$1.75 dozen.

COMET—The bunches are almost approaching grapes in size, being frequently 8 inches in length, with from 20 to 26 berries of enormous size and of the most brilliant crimson color. The growth is abnormally vigorous. It will hang a long time in good condition. The first picking has been made as soon as the 10th of June and the last as late as the 22d of August during 3 seasons from the same bushes. 20c each; \$1.75 dozen.

NUT-BEARING TREES

	Each.
English Walnut.....	\$0.75
American Chestnut, 5 to 6 feet.....	.75
Japan Chestnut, 2 to 3 feet.....	1.50
Spanish Chestnut, 3 to 4 feet.....	1.50
Black Walnut, 4 to 6 feet.....	.75
Japan Walnut, 4 to 5 feet.....	.75
Pecans, 1½ to 2 feet.....	.75
Hickory, 1½ to 2 feet.....	1.50

HEDGE PLANTS

Evergreen must be handled with care; the roots should not be allowed to dry out. Plants for hedges should be placed about 12 inches apart, more space being allowed for larger plants. California Privet, Honey Locust and Osage Orange are generally planted in double rows about 9 inches apart. Other deciduous shrubs for hedges should be planted about 12 inches apart.

EVERGREEN HEDGE PLANTS—Arbor Vitae (American), Pine (Austrian), Arbor Vitae (Siberian), Pine (Scotch), Mahonia Aquifolia, Norway Spruce, Tree Box (in variety), Dwarf Box.

DECIDUOUS HEDGE PLANTS—Berberis Thunbergii, Buckthorn, Honey Locust, Japan Quince, Osage Orange, Privet (California), Rosa Rugosa, Spireas, Tamarix, Thorn (Coccinea), Thorn (Crus Galli).
Price on Hedge Plants on application.

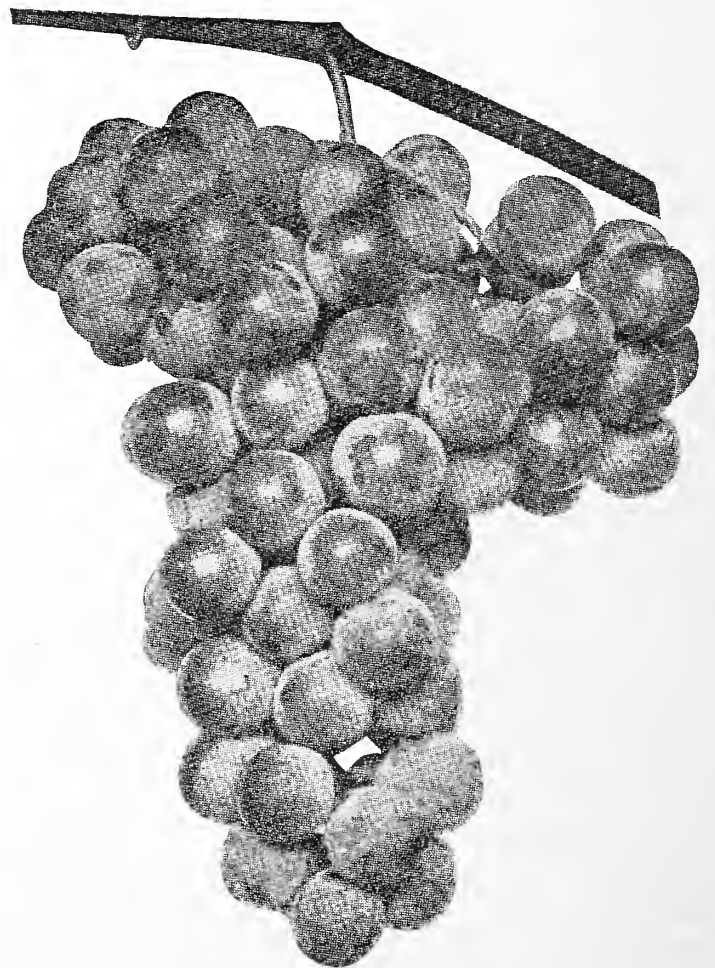

SPRAY CALENDAR

WHAT TO SPRAY	FOR WHAT TO SPRAY	WITH WHAT TO SPRAY	When to Spray			REMARKS AND CAUTION
			First Spraying	Second Spraying	Third Spraying	
Apple.....	Codling Moth	Arsenates in Bordeaux or arsenate of lead 3 lbs. to 50 gals.	As soon as blossoms fall	7 to 10 days later	30 days later	Later spraying if made should be made with diluted solutions
	San Jose Scale	Lime-Sulphur	Late in fall, late in winter or early in spring			Use Lime-Sulphur only when trees are dormant
	Scab	Bordeaux Mixture	Just before blossoms open	Within a week after blossoms have dropped	Same 7 to 10 days later	The spray just before blossoms open is very essential for scab
	Woolly Aphis	Kerosene Emulsion	When trees are in full leaf	In fall		Don't use strong emulsion when trees are in full leaf
Asparagus.....	Asparagus rust	Bordeaux	After cutting crop	10 days later	10 days later	Repeat 3 to 4 times. Burn rusted brush in the fall
Bean.....	Anthracnose	Bordeaux	On 2 or 3-inch plants	10 days later	After blossoms	
Cabbage and Cauliflower...	Cabbage Worm	Pyrethrum	With first appearance of worms	Whenever worms are observed	Same	1 oz. to 30 gals. of water
Cherry.....	Rot	Bordeaux	Before blossoming	After blossoming drop on fruit	Two weeks later on fruit	When fruit is large
	Curculio	Arsenate of lead	Before blossoming	As blossoms dry up	One week later	Avoid strong solutions. Do not use other arsenicals than arsenate of lead
Cucumber.....	Cucumber Beetle	Arsenate of lead in Bordeaux	Soon as plants appear	Week later	Week after second	Week after fourth
	San Jose Scale	Lime-Sulphur	As with apple	In spring as with apple		
Currant.....	Worm	White Bellebore	When worms first appear	Repeat in 3 or 4 days	Repeat as second	Look for worms on under side of leaves first
	Mildew	Bordeaux	Before blossoms open	After blossoming	Two weeks later	
Gooseberry.....	Worm	White Hellebore	As on Currants			
	Anthracnose	Bordeaux	Just before buds open	Just before blossoming	Just after fruit has set	
Grape.....	Downy and Powdery Mildew and Rot	Bordeaux	Just before blossoming	Just after fruit has set	7 to 10 days after	Follow by two or three sprayings
	Leaf Curl	Bordeaux	In fall or spring	As buds are opening	Just after calyx drops	
Peach.....	Rot and Scab	Bordeaux	As buds are swelling	Just after calyxes drop	2 to 3 weeks later	Destroy all mummies
	Bud Moth	Arsenates in Bordeaux	With opening of buds			Use only half usual amount of poison
	San Jose Scale	Lime-Sulphur	In late fall or early spring			
	Scab	Bordeaux	When leaves are half grown	After blossoms drop		
Pear.....	Codling Moth	Arsenates in Bordeaux	As with Apple	Same as first		See Apple
	San Jose Scale	Lime-Sulphur	In fall or early spring			
	Rot	Bordeaux	As buds are swelling	Just after calyx drops	3 or 4 weeks later	Repeat every 7 or 10 days
Plum.....	Curculio	Arsenate of lead in Bordeaux	With starting of buds	Just after calyx drops	5 days later	Destroy all mummies
	San Jose Scale	Lime-Sulphur	In late fall or early spring			Jar, gather and destroy curculios and stung plums 90 minutes
Potato.....	Early Blight	Bordeaux	When plants are 6 inches high	Two weeks later	Two weeks later	
	Scab	Soak seed in arsenites alone or in Bordeaux	Corrosive sublimate	Solution (2 oz.)	In 16 gallons	Arsenate of lead, 3 lbs. to 50 gals. of water for Colorado Beetle alone
	Colo. Beetle	Bordeaux	When beetles or young appear	As for first		
Quince.....	Fruit and Leaf Spot	Bordeaux	Just before blossoms open	After blossoms drop	Two weeks later	
	San Jose Scale	Lime-Sulphur	In late fall or early spring			
Raspberry and Blackberry...	Anthracnose	Bordeaux	Before leaves open	Bord. on canes 6 inches high	Repeat second 1 week later	Keep spray from leaves on bearing canes
Rose.....	Leaf Spot	Bordeaux	With first appearance of fungus	2 or 3 weeks later	Repeat if necessary	
	Slug	Arsenites in Bordeaux or Hellebore	On appearance of slugs	Repeat if necessary		
Strawberry.....	Leaf Spot	Bordeaux	On new growth after crop	2 or 3 weeks later		
Tomato.....	Anthracnose	Bordeaux	Soon after fruit begins to set	3 weeks later	3 weeks later	

INSECTICIDES



HAMMOND'S SLUG SHOT

A non-poisonous powder. It requires no further mixing or preparation; easily applied; not injurious or dangerous to animals, the person applying it, or fruits and vegetables treated; destroys potato bugs and beetles, green and black

flies, slugs, worms, caterpillars, etc. 10 to 40 pounds is sufficient for an acre.

1-lb. pkg. \$0.15
5 lbs.45

HAMMOND'S GRAPE DUST
For blight and mildew.
5 lbs. \$0.60

PARIS GREEN
1/4 lb. \$0.15
1/2 lb.30
1 lb.50
2 lbs.90
5 lbs. 2.00

BLUE STONE, or COPPER SULPHATE
Prices on application.

FLOUR OF SULPHUR
1 lb. \$0.15 25 lbs. \$2.00
5 lbs.60 50 lbs. 3.50
10 lbs. 1.00 100 lbs. 6.50

Special prices in barrel lots.



A Combined Insecticide and Fungicide

WHY PYROX IS BETTER

It is a better fungicide because it controls serious fungus diseases that other materials do not control. It is a better insecticide because it kills insects such as the hard-shell potato beetle and the rose bug, which are not killed by other insecticides.



It is made of the purest available raw materials. It is chemically tested at every stage of its manufacture to make it safe for you to use.

Pyrox is all ready to use by simply mixing with cold water. It is so smooth and fine that it goes through the finest spray nozzles without clogging. It can be sprayed as fine as fog. It goes farther and does better work.

It sticks like paint. It stays on for weeks. Re-spraying is necessary only to cover new growth. It gives thorough protection during rainy weather when insects and disease do their deadliest work.

1-lb. pkg. \$0.40 25-lb. pkg. \$ 5.75
5-lb. pkg. 1.50 50-lb. pkg. 10.00
10-lb. pkg. 2.50 100-lb. pkg. 18.00
300-lb. pkg. \$51.00

Send for Book on Spraying—
Sent Free on Request.

SULPHO-TOBACCO SOAP

A safe and sure exterminator of all kinds of insects and vermin. Packages 10c and 20c



STERLINGWORTH FISH OIL SOAP

A combination of Fish Oil Soap and Tobacco, so compounded that it combines with the valuable properties of this soap the insecticide values of tobacco and nicotine. For

Oyster Shell or San Jose Scale, Red Spider, Plant Lice and all sucking insects.
1 lb. \$0.30 5 lbs. \$1.15

NIKOTEEN

Is the most powerful known insecticide, and will be found more economical and convenient than weak tobacco extracts.

Price:

Pint. \$2.00

SCALECIDE.

Used for the destruction of the San Jose Scale. Dilute at the rate of one gallon Scalecide to 20 gallons water. Scalecide does not clog nozzles, hose or pump, and is pleasant to use. Spray during the winter or early spring when the trees are dormant. **Qt. 60c; 1 gal. \$1.45; 5 gals. \$6.45; 10 gals. \$11.00; 30 gals. \$27.00; 50 gals. \$39.50.**

STERLINGWORTH POWDERED HELLEBORE

Destroys eating insects on plants, shrubs, currant bushes, vegetables, etc. Is a valuable insecticide and repellent to all eating insects attacking currants and rose bushes, cabbages, squash, cucumber, etc.

1/4 lb. \$0.25
1/2 lb.45
1 lb.80



NICO-FUME

Nico-Fume is a Tobacco Paper Insecticide for fumigating greenhouses. Extensively used by prominent florists.

24 sheets. \$1.35 144 sheets. \$6.00
288 sheets. \$11.00

LEMON OIL CO.'S STANDARD INSECTICIDE (Soluble in Water)

The cheapest and most effectual plan for destroying insects and cleaning the plants is by dipping when possible. A man will thoroughly cleanse as many plants in 1 hour this way as he could in several days by sponging. A No. 1 pot with the drainage hole corked will be found a capital dipping vessel for ordinary-sized plants. For larger plants a barrel with one-third sawed off, will answer the purpose. Climbers can be syringed or sprayed in any position, as the drip will not hurt the most delicate object.



Prices:

1/2 pt. \$.35
1 pt.60
1 qt. 1.00
1/2 gal. 1.75
1 gal. 3.00
5-gal. can. 12.00
10-gal. can. 22.50

TOBACCO DUST

For green and black aphids, fleas, beetles, etc. Splendid fertilizer and preventative for insects in the ground and around roots. For insects on plants apply with powder duster or bellows. For worms or grubs in the soil apply liberally to the surface and rake in, or strew thickly in the drills before planting.

5 lbs. \$0.25
20 lbs.80
100 lbs. 2.50

TOBACCO STEMS

Indispensable for fumigating greenhouses and conservatories for the destruction of green and black aphid and other insects.

Dampen thoroughly a few hours before using, place about 1/2 pound over a handful of shavings in a fumigator and light.

50-lb. bale, per lb. . . \$0.03 100 lbs. \$2.00

LIME-SULPHUR SOLUTION

This material combines the great fungicidal properties of Sulphur with the scale remedy, and is specially recommended for Peach and Plum Trees, which need the combined treatment in the Fall and Spring. In spraying this material care should be exercised to avoid getting it in the eyes, and gloves should be worn to protect the hands.

1-pt. cans. \$0.25 5-gal. cans. \$3.75
1-qt. cans.40 10-gal. cans. 5.50
1/2-gal. cans.65 1/2 bbl., per gal.27
1-gal. cans. 1.00 1 bbl., per gal.22

Special price in larger quantities.

Add 9 to 10 parts cold water to 1 part LIME-SULPHUR SOLUTION and stir thoroughly. Apply with spray pump.

TREE TANGLEFOOT

For protecting trees against climbing insects pest in a simple, economical and effective way, use Tree Tanglefoot—a sticky substance applied directly to the bark of trees. One application remains sticky on the trees months fully exposed to the weather. Easily applied with a small wooden paddle. One pound will spread 8 feet long and 5 inches wide, 1-16 inch thick. Will stay on tree 3 months.

1-lb. can.....\$0.50 3-lb. can.....\$1.45
10-lb. can.....\$4.50

BORDEAUX MIXTURE (Powder)

For blight on Potato, Tomato, Celery Plants, Trees, etc., also for fungous diseases.

1-lb. pkg., per lb....\$0.45 5-lb. pkg., per lb....\$0.40
Larger sizes quoted on application.

BORDEAUX MIXTURE (Paste)

Recommended for Rust, Scab and all kinds of Rot and other fungous diseases. Should be used on Potatoes, Grape Vines and all Fruit Trees.

Directions—For Apple and Pear Trees, 10 to 12 pounds to 50 gallons of water; Peach and Plum Trees, 6 to 8 pounds to 50 gallons of water.

1-lb. pkg.....\$0.30 25-lb. pkg., per lb...\$0.20
5-lb. pkg., per lb.... .25 50-lb. pkg., per lb... .19
10-lb. pkg., per lb.... .22 100-lb. pkg., per lb.. .18
Barrels, 200 lbs., per lb....\$0.17

APHIS PUNK (Nikoteen)

Especially designed for use in private places and in houses without convenient furnaces for heating irons necessary for vaporizing Nikoteen or Tobacco Extract. It is very effective as an insecticide. The Punk is lighted with a match and allowed to burn, which it does without flaming, at the same time giving off dense white fumes of Nikoteen that kill aphis and thrip very effectively.

Per box.....\$0.80 Per 12 boxes.....\$8.50

ARSENITE OF ZINC (Powder)

A powerful insecticide for all leaf-eating insects, particularly those that infect Potato, Tomato, Cucumber and Cantaloupe vines. Used extensively by all the truckers in this section.

1-lb. pkg.....\$0.55 25-lb. pkg., per lb...\$0.42
5-lb. pkg., per lb.... .50 50-lb. pkg., per lb... .40
10-lb. pkg., per lb.... .45 100-lb. pkg., per lb.. .38

FORMALDEHYDE

It is of pronounced efficiency in destroying disease germs affecting both animal and plant life, and is successfully employed as a preventive of such fungoid diseases as potato scab, onion and grain smuts, musty corn and other affected seeds, damping off seedlings, club root of roses, etc. The dilution for most purposes is 1 pound (1 pint) to 15 or 20 gallons of water, and 1 to 2 gallons of this dilution is required for the treatment of a bushel of seed.

1-pt. bottle.....\$0.60 1-qt. bottle.....\$1.00
1-gal. can.....\$3.50

TRADE KAYLOX MARK

Registered in U. S. Patent Office.

INSECTICIDE AND FUNGICIDE

Kills Insects and prevents Blight

CAN BE USED FOR DUSTING AS WELL AS SPRAYING

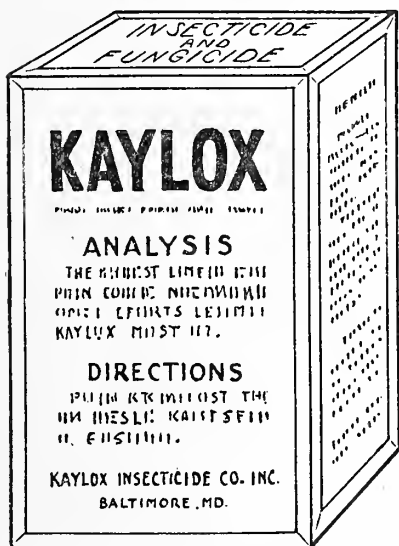

KAYLOX is adapted for spraying for late broods of Codling Moth on Apples, for Potato Beetles, most Caterpillars and many leaf-eating Insects on fruit and other trees, Tomatoes, Grapes, Currants, Celery, Cabbage, Cauliflower and many other Plants.

A preventive of many Blights and certain Fungous diseases.

Used as a general spray—1 pound to 10 gallons or 5 pounds to 50 gallons of water.

For Potatoes, Bitter Rot and Blotch on Apples. Use 1 pound to 7½ gallons or 6½ or 7 pounds to 50 gallons of water.

Not to be used for late Spring or early Summer

application on Apples, and not to be used on Peaches or Japanese Plums.

Kaylox is in convenient size packages.

½ pound makes 5 gallon spray.....\$.35
1 pound makes 10 gallon spray..... .65
5 pounds makes 50 gallon spray..... 2.75
10 pounds makes 100 gallon spray..... 4.70
25 pounds makes 250 gallon spray..... 41.00
50 pounds makes 500 gallon spray..... 42.00
100 pounds makes 1000 gallon spray..... 40.00

BUG DEATH

Kills Potato, Squash and Cucumber Bugs, Currant and Tomato Worms and all Bugs and Worms that chew the leaves of plants; non-poisonous.



Directions for Applying Dry: For potato and other vines which require a top application, apply drops with Shaker or Sifter at the rate of 15 to 25 pounds per acre to an application, according to size and conditions of the vines.

Directions for Using in Water: Add 15 to 25 pounds to 80 gallons of water and mix thoroughly.

1-lb. pkg.....\$0.20
Pat. March 16 and 3-lb. pkg..... .50
Nov. 9, 1879. Pat. 5-lb. pkg..... .75
in Canada Nov. 2, 12½-lb. pkg..... 1.25
1897, and Jan. 25, 100 lbs..... 9.00
1900.

DETHOL

**Germicide Insecticide
Disinfectant Deodorizer**

KILLS INSECTS

ALMOST INSTANTLY

such as Flies, Roaches, Water Bugs, Lice, Fleas, Ants, Mosquitoes; Chicken, Hog and Cattle Lice, but harmless to higher animal life. A positive moth preventive. It will not stain or injure the finest fabrics, nor affect colors; does not harm wall paper or corrode metal.

Non-explosive, sure, quick, clean, safe and economical to use.

To kill Flies out doors a compressed-air sprayer must be used.

Invaluable to housekeepers: To keep down dust, spray everywhere around the house before sweeping.

Price:

1-pt. can.....\$0.50 1-qt. can.....\$1.00

"BLACK LEAF 40"

A Concentrated Solution of Nicotine Sulphate

For spraying against sucking insects, such as Green and Woolly Aphis, Pear Psylla, Grape Leaf Hopper, Pear Thrip, etc., use 1 part Black Leaf 40 to about 900 to 1,000 parts water.

Against more resistant plant lice, such as Black Aphis and Rosy Apple Aphis, 1 part Black Leaf 40 to 500 parts water.

Black Leaf 40 is permitted by the United States Government and by State regulations to be used in official dippings of Sheep and Cattle for Scabies.

Full directions on every package.

Prices:

1 oz.....\$0.25 2-lb. can.....\$3.75
½-lb. can..... 1.25 10-lb. can.....15.50
F. O. B. Baltimore.

BORDEAUX ARSENATE-LEAD MIXTURE (Paste)

This is a combined fungicide and insecticide specially recommended for Apple and Pear Trees; also for Potatoes, Melons and Cucumber Vines.

Directions—Apple and Pear Trees, 8 to 12 pounds to 50 gallons of water and stir.

1-lb. pkg.....\$0.45 25-lb. pkg., per lb..\$0.32
5-lb. pkg..... .40 50-lb. pkg., per lb.. .31
10-lb. pkg., per lb... .35 100-lb. pkg., per lb.. .30
Barrels, 300 lbs., per lb....\$0.29

ARSENATE OF LEAD (Paste)

Kills Codling Moth, Worms, Curculio, Caterpillars, Potato Bugs, Rose Bugs, and all chewing insects without injury to foliage or buds.

Directions—For all chewing insects, use 2 to 4 ounces to 1 gallon of water. Add water slowly till rubbed to a thin paste before adding to the volume of water.

1-lb. pkg.....\$0.35 25-lb. pkg., per lb..\$0.27
5-lb. pkg., per lb... .30 50-lb. pkg., per lb.. .20
10-lb. pkg., per lb... .25 100-lb. pkg., per lb.. .19
Barrels, 200 lbs., per lb....\$0.18

ORIOLE WEED KILLER

1 gal.....\$1.50 10 gals.....\$12.00
5 gals..... 6.50 Bbl., per gal..... 1.00

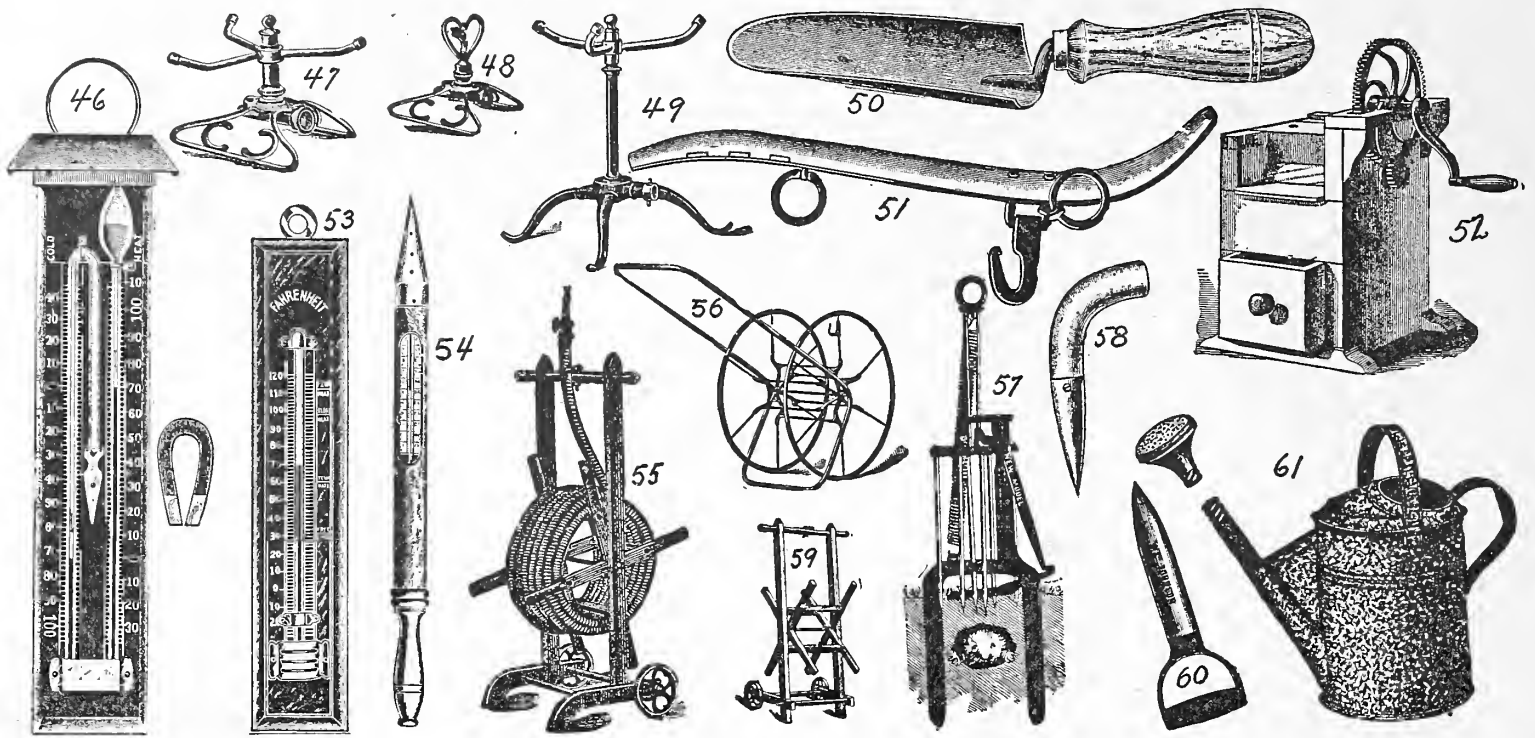

THERMOMETERS

Registering Thermometer (Fig. 46).....	\$5.50
8-in. Wood-Back Thermometer (Fig. 53).....	.50
Hotbed Thermometer (Fig. 54).....	2.00
Distance Reading Thermometer.....	.50
8-in. Tin Mercury Thermometer.....	.25
Incubator Thermometer.....	.85
Brooder Thermometer.....	.85
High-grade Cottage Thermometer.....	1.00

LAWN SPRINKLERS

Pluvius—(Fig. 49)—One of the best on the market 15 inches high. **\$1.75.**
Ring Sprinkler—Made of heavy brass. Makes a mist-like spray. Each, **\$1.00.**

GARDEN HOSE and REQUISITES

(Fig. 55)

We carry in stock a full line of Garden Hose, 3 and 4-ply. Prices range from **8c** to **20c** per foot. We invite your inspection.

Iron Hose Reel (Fig. 56).....	\$2.75
Wood Hose Reel (Fig. 59).....	1.00
Hose Couplings, pair, 30c ; each.....	.15
Hose Clamps, ½ inch and ¾ inch, dozen.....	.40
Combination ¾-inch Hose Nozzle.....	.40
¾-inch Brass Nozzle.....	1.00

HAMES and STRAPS

Iron-Bound Hames (Fig. 51), pair.....	\$2.25
London Patent Hames, pair.....	2.25
Taylor Root Hames, pair.....	1.75
Hame Strings, ¾-inch Rawhide, each.....	.20

HORSE-RADISH GRATER

(Fig. 52)

With Tin-Clad Cylinder.....	\$12.00
With Steel-Pin Cylinder.....	14.00

GALVANIZED WATER POTS

(With Adjustable Nozzles)

4 quart.....	\$0.75
6 quart.....	.90
8 quart.....	1.00
10 quart.....	1.15
12 quart.....	1.25
16 quart.....	1.50
20 quart.....	2.25

GARDEN TROWELS

English Wrought Shank, 6 inch (Fig. 50).....	\$0.40
8 inch.....	.50
Florist Trowels, Stamped Steel, 6 inch.....	.25
Cheaper grade.....	.10
Plaintain Trowels, No. 2, 5-inch Blade.....	.15
No. 1, 8-inch Blade.....	.25
Wood-Handle Dibble (Fig. 58), Steel Point.....	.35
Iron-Handle Dibble (Fig. 60), Steel Point.....	.50

MOLE TRAPS

Olmstead—The best on the market; made entirely of steel and iron; very compact. **\$2.00.**
Out-o'-Sight—Convenient to use in hotbeds. **\$1.25.**

STABLE ACCESSORIES

Canvas Back Bands—Heavy and full length, with patent snap. **\$1.00**
Trace Chains—Extra long, strong and durable. Per pair, **\$1.25.**
Cow Chains—For tying out in fields. 20 feet long. **\$1.25**; 30 feet long, **\$1.50.**
Breast Chains—Double, pair, **\$1.25**; Single, pair, **\$1.00.**
Plow Lines—Cotton, pair, **80c**; Sisal or Hemp, pair, **60c.**
Curry Combs—Eight bars; steel, **25c.**
Horse Brushes—Leather back, **\$2.50.**
Stable Push Brooms—Rattan and Bass, **\$1.00.**

MANN'S GREEN BONE CUTTER

(Latest Model)

The feed is both automatic and self-governing. Cuts all gristle and meat. Nothing escapes uncut.

No. 5C—This machine is exactly the same as the No. 5B, with a crank handle instead of a balance wheel. Capacity not quite equal to 5B. Weight 35 lbs. **\$11.00.**

No. 5B—This machine is exactly the same as No. 5BM, except that it has not the iron stand. The capacity is the same. Weight 60 lbs. **\$14.50.**

No. 5BM—Intended for flocks of 15 to 25 hens. Mounted on iron stand. Cylinder 6 inches diameter, 4 inches deep. Cutter plate has 4 knives instead of 3. **\$18.50.**

No. 7—Intended for flocks of 40 to 100 hens. Mounted on strong iron stand with large table for box or pan to receive cut bone. Weight 700 lbs. Cylinder 7¼ inches in diameter, 5¾ inches deep. Capacity ½ to 1 lb. per minute. **\$21.25.**

No. 11—Intended for large flocks of over 100 fowls. Capacity 100 lbs. per hour. Horse power required, 1 to 1½. Weight 215 lbs. Diameter of pulley 15 inches, 3½-inch face. Speed of pulley 300 to 350 revolutions per minute. **\$46.00.**

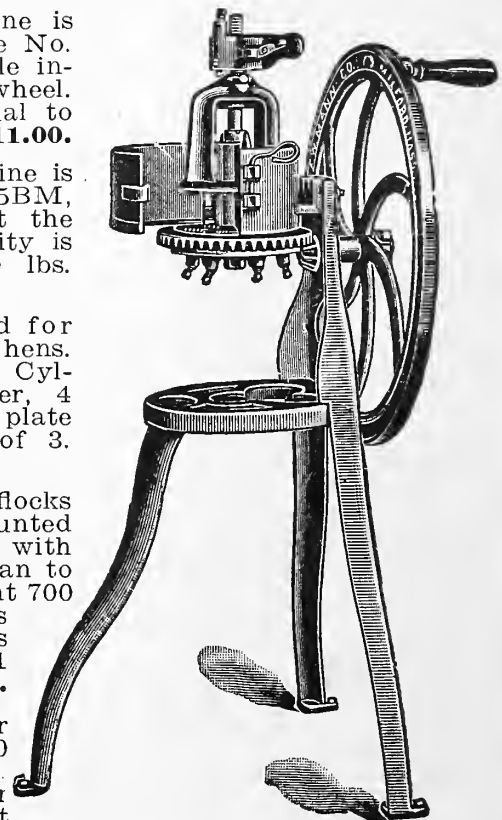



GRASS HOOKS

“Blue Ribbon” Grass Hook—(Fig. 43). 75c.
 Grass Hooks—(Fig. 2), English, \$1.00 and \$1.25.

HAY KNIFE, CORN KNIVES and HOOKS

Lightning Hay Knife—(Fig. 45). \$1.50.
 Corn Knives—Straight, concave or convex edge, 25c to 75c.
 Corn Hooks—35c each.

SCYTHES, SNATHS and SCYTHE STONES

English Waldron Scythes—36 inch, \$2.65; 38 inch, \$2.75; 40 inch, \$2.85.
 Silver Steel Waldron Scythes—Imported. Very keen cutter, 32 to 36 inches, \$1.50.
 38-40-inch Clipper Grass Seythe—\$1.50.
 American Weed Scythes—(Fig. 44), \$1.25; Bramble, \$1.25.
 Scythe Stones—English, 30c; Darby Creek, 20c.
 Snaths—(Fig. 41), Patent Grass, \$1.50; Heavy Two-Ring Bush Snaths, \$1.50.

GRAIN CRADLES

Handsome Four-Fingered Cradle, with American blade, \$5.50.
 Cradle Blades—American, \$1.75.

HEDGE, PRUNING and BORDER SHEARS

Solid Steel Imported Hedge Shears—(Fig. 5). The celebrated English Shears, 10-inch, with notch, \$2.75; 9-inch, with notch, \$2.25; 8-inch, with notch, \$2.00. All 25c less without notch. The notch is very useful in heavy trimming or lopping.
 No. 1 “Red Clipper” Draw Cut Pruning Shears—(Fig. 8). Made of best tool steel, hand-forged, oil-tempered. 25-inch handles, \$3.00; 22-inch handles, \$2.75.
 No. 105 Border Shears—(Fig. 7), 10-inch, \$5.00; without wheel, \$4.75.
 Lopping Shears—24-inch handles, \$3.50.
 Lawn Shears—Two wheels, 8-inch blade, for cutting on narrow borders, under fences and shrubs, \$6.50.

PRUNING SAWS and BUSH HOOKS

Double Pruning Saw—(Fig. 39), 18-inch, \$1.30; 16-inch, \$1.25.
 Bush Hooks (Axe Handle)—(Fig. 40), \$2.25.

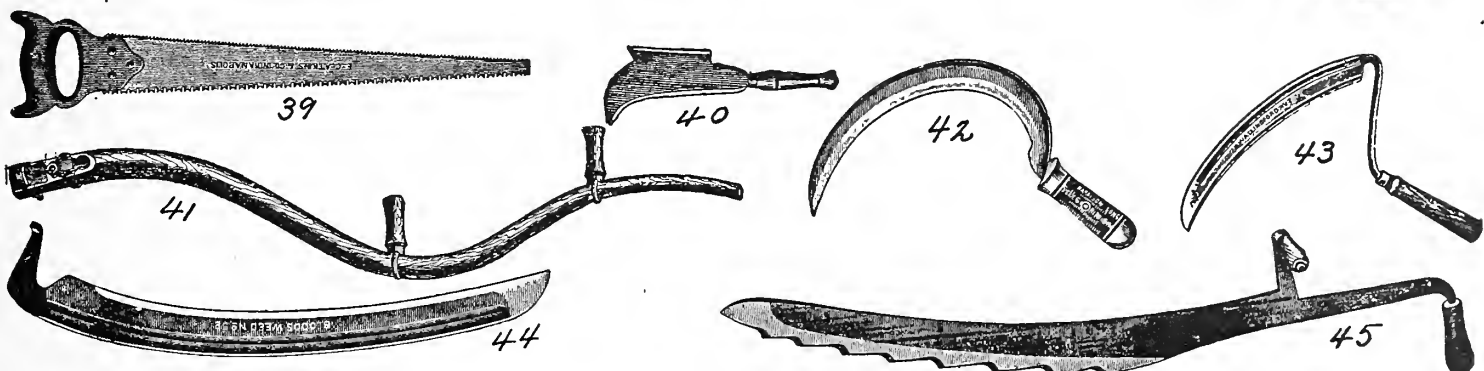

PRUNING SHEARS

8½-inch full-polished Pruner, \$1.50; 8½-inch half-polished Pruner (Fig. 1), \$1.00; 8½-inch japanned Pruner, 85c; 8½-inch French Pruner (very good), \$2.25; 6-inch Ladies’ Pruner, full polished, 75c and \$1.00; 7-inch Grape Picker (Fig. 6), \$1.00.
 Flower Gathering Scissors—Large and perfect; do not tire the hands, \$1.00.

TREE PRUNERS and KNIVES

Waters—(Fig. 4). The best known. 6-foot, \$1.25; 8-foot, \$1.40; 10-foot, \$1.50; 12-foot, \$1.75.
 Budding Knives—Ivory handle (Fig. 11), \$1.50; Horn and Ivory (Fig. 10), \$1.25.
 Pruning Knives—The best made (Fig. 12), \$1.00.
 Telegraph Tree Pruner—Without pole, \$1.75.

GRAFTING WAX

¼ lb.....15c ½ lb.....25c Lb.....50c

WILSON’S BONE and SHELL MILL

This is without a doubt the best Bone and Shell Mill on the market. For grinding dried bones or shell it has no equal. Made strong and durable. A mill every poultryman ought to have.
 Price, No. 1.....\$6.75

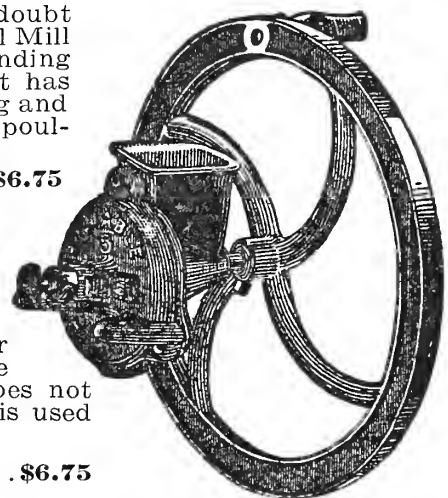

WILSON’S GRAIN MILL

No. 0—Made similar to the No. 1 Bone Mill, except that it does not have the crusher and is used for grinding grain only.
 Price.....\$6.75

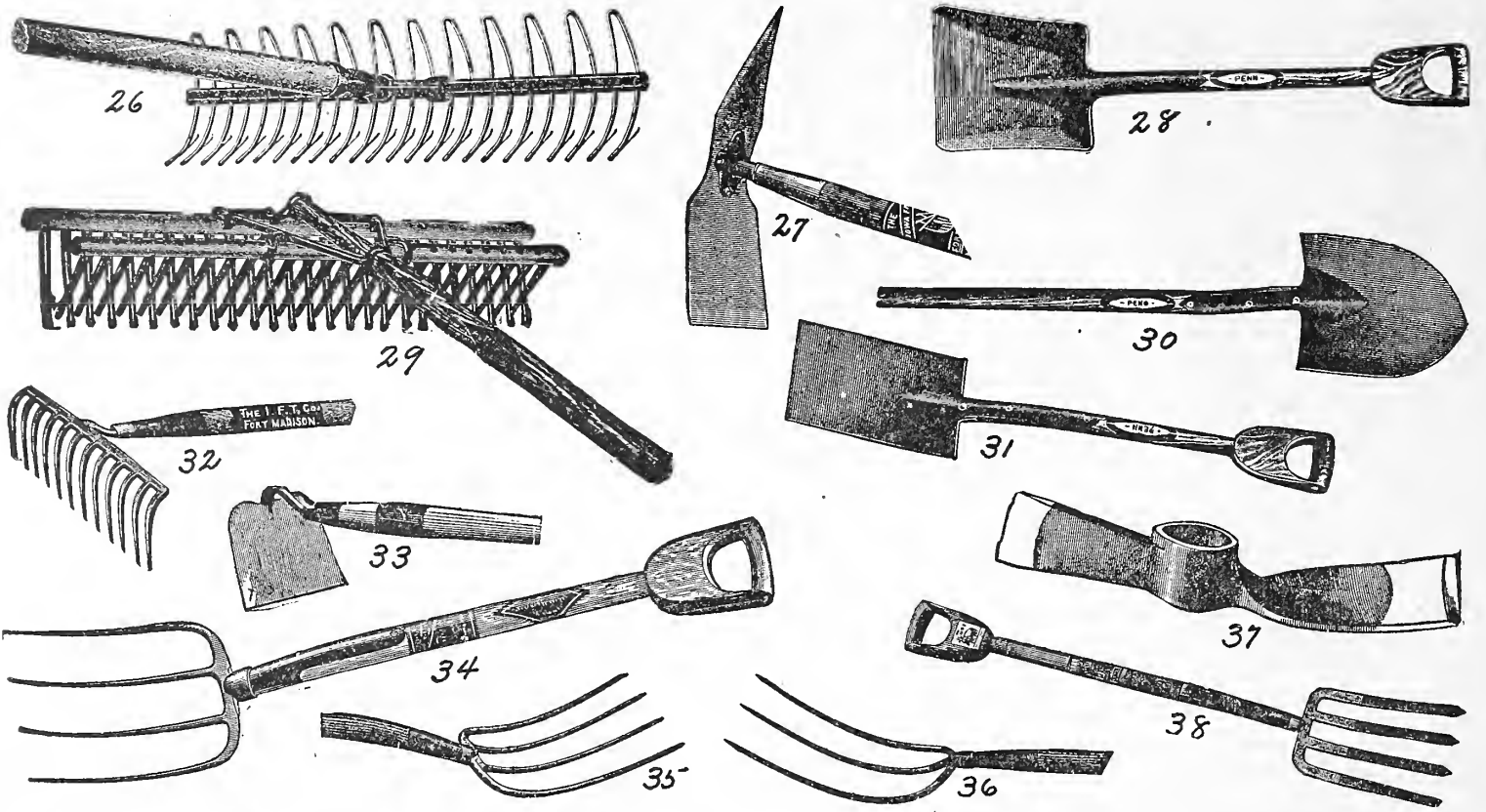

GARDEN, LAWN and HAY RAKES

Self-Cleaning Lawn Rake—(Fig. 29). Readily cleaned by a back motion of the rake. Will not tear grass. 22-tooth, **85c**; 26-tooth, **\$1.00**.

Lawn Queen Rake—(Fig. 26). Steel head, with heavy steel wire teeth. Strong and durable. Reversible for leaves. 21 inches wide, 24 teeth, **75c**; 21 inches wide, 46 teeth, **90c**.

Superior Hand-Made Wood Lawn Rakes—The best of its kind; very substantial. 20-tooth, **50c**.

Superior Hand-Made Hay Rake—20-tooth, **35c**.

Steel Garden Rakes—(Fig. 32). 14-tooth, **90c**.

Malleable Garden Rakes—12-tooth, **60c**.

Ole Olsen Rake—Very strong, durable wood. This rake head is slightly curved from the center to each end, which does not allow any material that has been caught by the teeth to slip around the edges. 26-tooth, **75c**.

MANURE, HAY and SPADING FORKS

No. 64 Manure Fork—(Fig. 34). **\$2.50**.

Long-Handle Manure Fork—(Fig. 35). 4½-foot handle, 4 prongs, strapped, **\$1.25**.

Long-Handle Hay Forks—(Fig. 30). 2 prongs, **\$1.25**; 3 prongs, **\$1.50**.

D-Handle Spading Fork—(Fig. 38). **\$1.50**.

We have a full line of Handles in stock for Hatchets, Axes, Picks, Shovels, Forks, Saws, etc.

Kelly Axes—Excellent quality, **\$2.00**.

Kelly Axes—Complete, with handle, **\$2.50**.

Hatchets—High grade, **55c**; second grade, **40c**.

Axe Handles—**35c** and **50c**.

DIAMOND MESH WIRE

(Galvanized After Woven)

150 Feet in Roll

		2-in. Mesh.	
12 inches high, No. 20 wire.	Per roll	\$ 1.50
24 inches high, No. 20 wire.	Per roll	2.85
36 inches high, No. 20 wire.	Per roll	3.95
48 inches high, No. 20 wire.	Per roll	5.25
60 inches high, No. 20 wire.	Per roll	6.50
72 inches high, No. 20 wire.	Per roll	7.75

1-in. Mesh.

12 inches high, No. 20 wire.	Per roll	\$ 3.75
24 inches high, No. 20 wire.	Per roll	6.50
36 inches high, No. 20 wire.	Per roll	9.00
48 inches high, No. 20 wire.	Per roll	12.00
60 inches high, No. 20 wire.	Per roll	15.00

PICKS, MATTOCKS and HANDLES

Picks—Best steel, **\$1.50**.

Mattocks—(Fig. 37). Best, **\$1.50**; Good, **\$1.25**.

Pick and Mattock Handles—**50c**.

Ladies' and Children's Garden Tool Set—Consisting of Rake, Shovel, Hoe and Spading Fork. Made of first-class material. Not toys, but tools that will do and stand the work. Price, **\$1.75**.

SHOVELS and SPADES

D handle, square point. (Fig. 38). Best, No. 3, **\$1.50**; No. 4, **\$1.75**; second-grade No. 4, **\$1.25**; No. 5, **\$1.35**.

Long handle, round point. (Fig. 30). Solid back, **\$1.50**.

Coal Scoops—D handle. No. 4, **\$2.00**; No. 5, **\$2.25**.

Spade—D handle. (Fig. 31). **\$1.50**.

GARDEN, PLANTERS and SCUFFLE HOES

Solid Socket—(Fig. 33), 8-inch, **\$1.00**.

Riveted Shank—8-inch, **75c**.

1-Pt. Weed—(Fig. 27), 6-inch, **45c**.

2-Pt. Weed—6-inch, **45c**.

Handled Planters—7½-inch **90c**.

Scuffle Hoes—English. 8-inch, **\$1.25**; 6-inch, **\$1.50**.

Handled American Scuffle Hoe—**\$1.00**.

Potato Hooks—Oval, 4-tine, **\$1.15**.

Dock Lifter—Heavy, with D handle, **\$2.25**; light, **\$1.00**.

OIL CANS, OILS, AXLE GREASE

Machine Oilers—15c and 25c.

Mica Axle Grease—Lb. **15c**; 15 lbs. **\$1.75**; 25 lbs. **\$2.50**.

Harvester Oil—Gal. **75c**.

Gasoline Engine Oil—Gal. **75c**.

Hard Oil—For gasoline engine. 1½-lb. cans **25c**; 5-lb. cans, **\$1.00**.

Cream Separator Oil—Gal. **\$1.00**.

POST-HOLE DIGGER

(Fig. 50)

Strong and durable, easily operated, **\$2.50**.

New Champion—Post-Hole Digger, **\$2.00**.

Gibbs—**\$2.25**.

SLIDING KRAUT CUTTER

Sliding Kraut Cutter With 2, 3 or 4 Knives

No. 50—2 knives, 8x26 inches.....	\$2.00
No. 55—3 knives, 8x26 inches.....	2.50
No. 65—3 knives, 9x30 inches.....	4.25
No. 70—3 knives, 12x36 inches.....	6.75
No. 75—4 knives, 12x36 inches.....	7.50

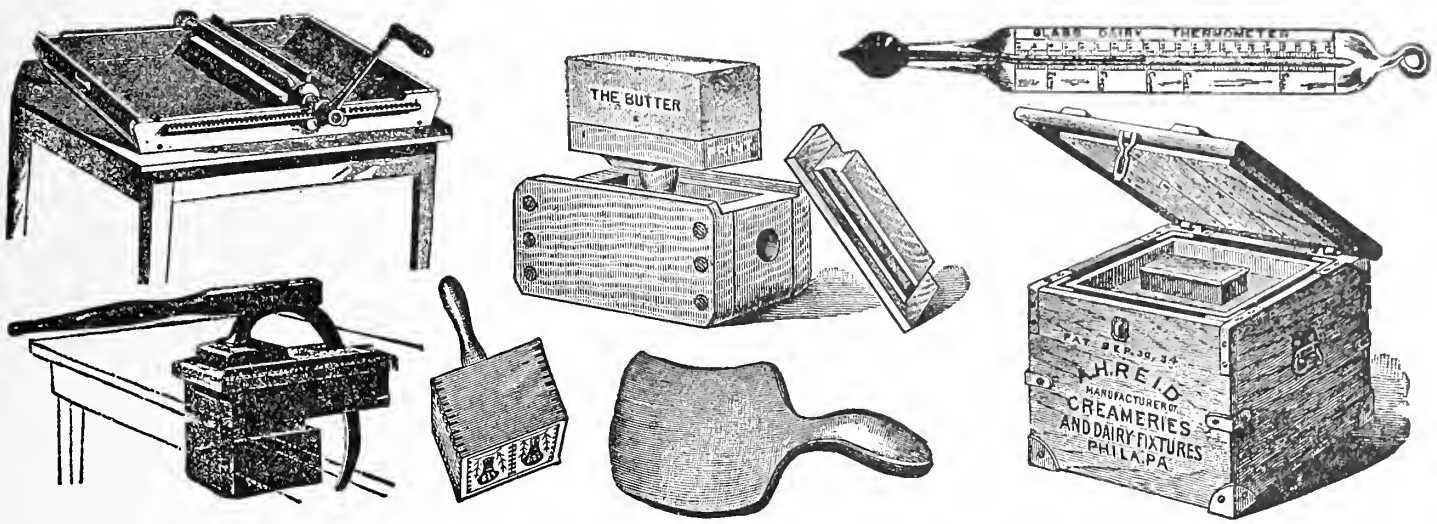

REID'S BUTTER WORKER

(Fig. 1)

This machine acts on the butter on precisely the same principle as a lade in the hands of a person, but with perfect uniformity and without injuring the grain. Made of the best material; iron parts galvanized, preventing rust.

- No. 1—Capacity, 50 lbs. or less.....\$16.00
- No. 2—Capacity, 30 lbs. or less..... 12.75
- No. 3—Capacity, 20 lbs. or less..... 11.25
- No. 4—Capacity, 10 lbs. or less..... 10.75

MILK CANS

Baltimore Pattern Railroad Milk Cans

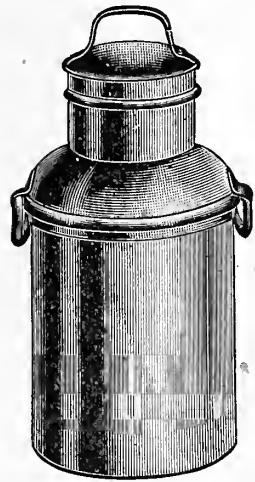

Our regular stock Can. Made of strong, very best material; straight neck, drop handle. Sizes: 12-qt., 20-qt., 30-qt., 40-qt. Name plates can be put on Can. Price on application.

MILK PAILS

Made of the best bright charcoal tin; strong and durable, with special bottom, which is a good feature.

- 12-qt.....\$1.00
- 14-qt..... 1.25

BUTTER SHIPPING BOXES

(Fig. 7)

Made of well-seasoned lumber, iron-bound edges and capped corners. The strongest package ever offered to shippers, and very convenient.

Capacity.	Price.
24 ½-pound prints.....	\$ 9.00
36 ½-pound prints.....	10.50
64 ½-pound prints.....	12.25
80 ½-pound prints.....	12.90
100 ½-pound prints.....	14.00
120 ½-pound prints.....	15.25
140 ½-pound prints.....	16.40
12 1-pound prints.....	8.00
20 1-pound prints.....	9.00
30 1-pound prints.....	10.00
40 1-pound prints.....	11.25
56 1-pound prints.....	11.75
80 1-pound prints.....	12.90
96 1-pound prints.....	14.00

WELLS, RICHARDSON & CO.'S BUTTER COLOR

The best Butter Color on the market. Small bottle, colors 500 lbs., 25c; large bottles, 50c and \$1.00.

THE BABCOCK TESTER

- No. 4-2 bottle size, for milk only.....\$6.00
- No. 5-2 bottle size, for milk and cream..... 6.75
- No. 6-4 bottle size, for milk only..... 7.35
- No. 7-4 bottle size, for milk and cream..... 8.00

Shipping weight, about 17 pounds.

All Testers are equipped with full set of glassware for testing milk or milk and cream; also furnished with brush and bottle of acid.

MISCELLANEOUS DAIRY SUPPLIES

Parchment Butter Paper—In sheets 24x36 inches, or cut for 1-pound and ½-pound prints. Price, 30c per lb. Special price on quantities.

Lafayette Butter Printer—(Fig. 4). Either 1-lb. or ½-lb. size. With table, \$27.00; without table, \$15.00. \$1.50 for monogram or initials.

Philadelphia Print—(Fig. 3). 1-lb. \$1.75; ½-lb. \$1.75.

Floating Dairy Thermometer—(Fig. 2). \$1.00.

Maple Print—Seeley—(Fig. 5). ½-lb. size, 60c; 1-lb. size, 75c.

Handmade Print—½-lb. \$1.00; 1-lb. \$1.50.

Butter Paddles—(Fig. 6). 10c to 40c.

Polished Maple Bowls—15-inch, 60c; 27-inch, 75c.

Freeman's Brick Butter Mold—Made with lock corners, from thoroughly seasoned timber. Perfect fitting. Hand carved, assorted designs. 75c each.

RICE'S CALF WEANER

Very effective for weaning calves and preventing cows sucking themselves.

No. 1, for calves, 35c; No. 2, for heifers, 50c; No. 3, for cows, 75c.



SHAW'S CALF and COW WEANER

The only successful Weaner in the world. Over 100,000 now in use. The animal this Weaner is put on can positively not suck, but at the same time it is no inconvenience to it to feed. Stop at our store and see it demonstrated. Price, No. 1, 65c; No. 2, 85c; No. 3, \$1.25.

STAR COOLER CREAM SEPARATOR

Made in the very best manner. The inner can is for milk and the outer can for water. The single Separator has 1 milk can and the double Separator has 2 milk cans. Inner cans can be readily taken out for cleansing. There is nothing better on the market. The outer cans are painted and decorated.

No. 000—Capacity, 1 cow, 14 quarts milk, \$5.25.

No. 00—Capacity, 1 to 2 cows, 2 quarts milk, \$6.50.



OX BALLS—Made of brass. Per pair, 75c.

BULL RINGS—Copper, 2½-inch, 45c; 3-inch, 50c.

HOG RINGERS—Each, 20c.

HOG RINGS—Hundred.....15c

PIG RINGS—Hundred.....15c

DAIRY SUPPLIES

PRIMROSE CREAM SEPARATORS

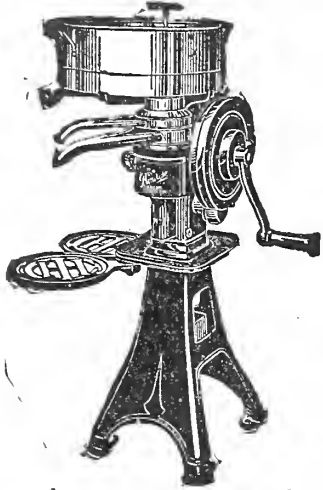

You may not class yourself as a dairy farmer, but if you keep a few cows and sell all or part of your cream you need a cream separator. The exclusive grain farmer has one harvest a year, but you have 730 harvests. Twice every day in the year you may be said to harvest your crop of milk. Separating it to get the butter fat might be compared to threshing the grain on the grain farm. If a grain thresher is badly adjusted or worn out, it often wastes many bushels of grain. Because the grain farmer threshes only once a year, his loss of grain for the foregoing reasons comes in one lump, and he feels it keenly. An unreliable or worn-out cream separator can easily lose 3 to 5 cents a day on each of your cows. The loss may amount to considerably more than the loss of the grain farmer, yet it is not noticed, because it occurs a little at a time.

You may not realize that these losses are heavy, but when you stop to think that butter fat is worth fifteen times as much as wheat, isn't it a good thing to find out what your separator is doing, and if it is wasting cream buy a new one at once? If you are still trying to get along without a separator, your losses from hand-skimming or any other method of recovering the cream are costing you more than the price of a good separator every year.

The question is not, "Do I need a cream separator?" but, "Which one shall I buy?" Here is the answer: Buy the one that has the most cream-saving features and which promises to continue skimmings clean year after year.

In the Primrose there is no obstacle in the path of the cream as it leaves the bowl. Other separators have what is termed a cream-regulating screw, which has a tendency to partially close the cream outlet. In the Primrose the regulating screw is in the skim-milk outlet, where it gives the same results as the cream-regulating screw in other separators without restricting the flow of all the cream out of the bowl. There is about thirty times as much skim milk as cream flowing out of the bowl when you are skimming, so that by regulating the skim milk you are dealing with a less sensitive element than the cream.

You may be a good enough mechanic to repair your farm implements, but you would hesitate to repair your watch. Regulating the density of the cream with a cream screw is like attempting to repair your watch. Regulating the density of the cream with a milk screw, as in the Primrose, is not a delicate adjustment. It is more like repairing your farm implements. You cannot fail to make the adjustment correctly with the Primrose, that is, get exactly the density of the cream you want every time you skim.

There are two cream outlets in the Primrose bowl instead of one, as in most separators. They provide ample space for the cream to flow out without breaking the fat globules. This insures uniform cream and smooth butter.

The Primrose Is Sold in Four Sizes

- No. 1—Guaranteed separating capacity, 350 pounds; 40.6 gallons of milk per hour. Price.....\$75.00
- No. 2—Guaranteed separating capacity, 450 pounds; 52.2 gallons of milk per hour. Price.....\$90.00
- No. 3—Guaranteed separating capacity, 650 pounds; 75.4 gallons of milk per hour. Price.....\$100.00
- No. 4—Guaranteed separating capacity, 850 pounds; 98.6 gallons of milk per hour. Price.....\$115.00

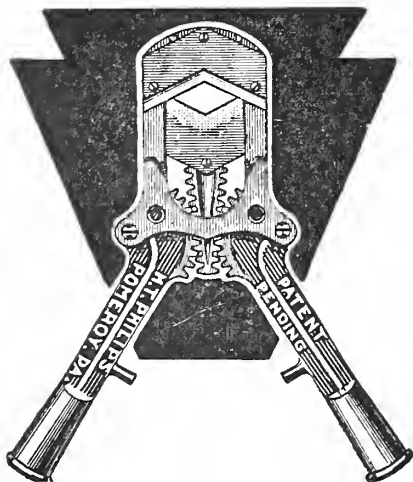

KEYSTONE DEHORNING CLIPPER

The practice of dehorning cattle is coming more into vogue. It is a mercy to the animals. Prevents goring. The blades on the Keystone are made of best steel. No twisting motion or second cut on horn. Parts are all interchangeable, and can be replaced. It is approved by veterinary surgeons and leading dairymen. The horns must go, and they cannot go too soon.

Clipper, with leader and rope, extra blades and screw, fully warranted, \$15.75.

Clipper alone, \$13.50.

DAVIS SWING CHURN

The finest Churn on the market. Has no floats or dashers; easy to clean; very easy to operate. Makes fine butter.

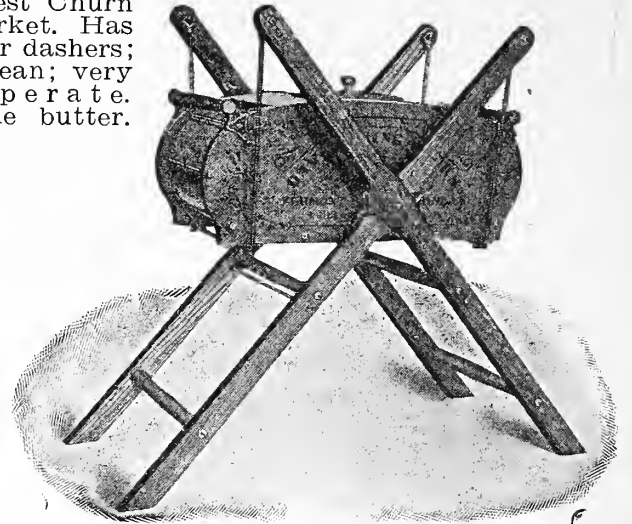

- No. 1—Churns 4 gallons.....\$13.25
- No. 2—Churns 5 gallons..... 14.85
- No. 3—Churns 8 gallons..... 16.50
- No. 4—Churns 10 gallons..... 19.80
- No. 5—Churns 13 gallons..... 26.10
- No. 6—Churns 17 gallons..... 26.40

THE FAVORITE CHURN

This Churn is made of good, hard material, well varnished, smooth on inside, making it easy to clean and perfectly sanitary. Well braced throughout. Will make butter quickly. One of the most popular Churns offered.



No.	Size, Gallons.	To Churn.	Price.
0	6	3	\$ 6.00
1	10	5	7.00
2	15	7	8.00
3	20	10	9.00
4	25	13	11.00
5	35	18	13.00
6	60	30	21.00
7	75	37	24.50
8	90	45	28.00

Pulleys for Large Sizes from \$2.50 to \$5.00.

THE BABCOCK TESTER

(Shipping weight about 17 pounds)



- No. 4—2-bottle size, for milk only.....\$6.00
- No. 5—2-bottle size, for milk and cream..\$6.75
- No. 6—4-bottle size, for milk only.....\$7.35
- No. 7—4-bottle size, for milk and cream..\$8.00

IMPROVED CEDAR CYLINDER CHURN

- No. 1—2½ gals....\$4.00
- No. 2—4 gals..... 4.50
- No. 3—7 gals..... 5.25
- No. 4—10½ gals... 6.00

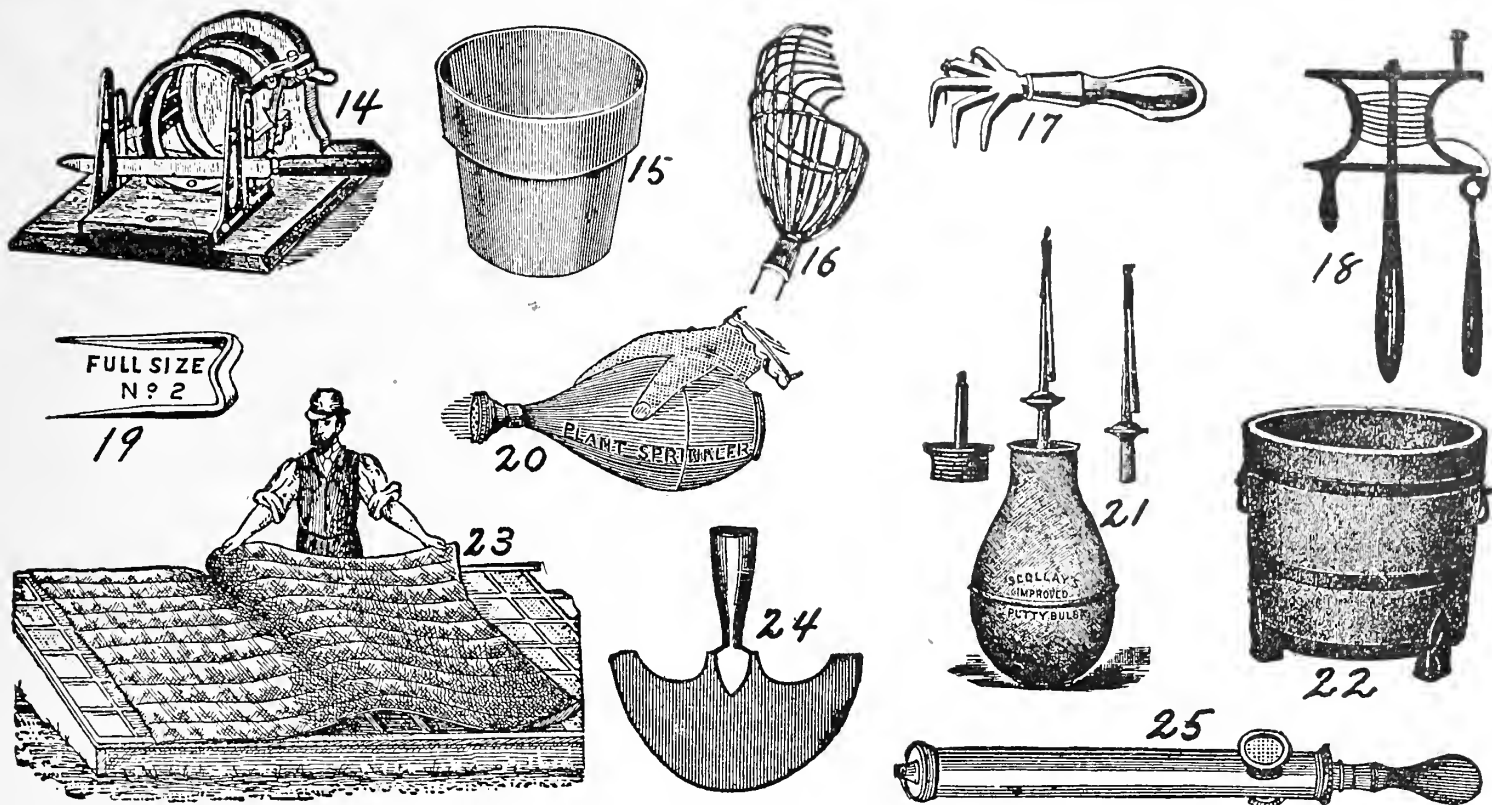

HOTBED SUPPLIES

Best White Pine Sash—Made to hold either 24 or 28 8x10 panes. These Sashes are grooved so that the panes slide in and butt one against the other. Price of either size, \$2.00 each.

Hotbed Glass—8x10. Per box of 90 panes, \$4.00.

Hotbed Mats—(Fig. 23). Interlined with wool. 40x76 size, covers 1 sash, \$2.25; 76x76, covers 2 sash, \$3.75. Special prices by dozen.

Marlin—For making straw mats. 5 lbs., \$2.50.

Tremlow's Old English Glazing Putty—Semi-liquid and elastic. For bedding glass in sash or for filling cracks or seams in roof joints or frames of greenhouses or hotbeds. Applied with machine, bulb or brush. This Putty is ground in pure linseed oil and will stay on. 1-gallon can, \$2.25.

Putty Bulbs—(Fig. 21). Scollay's, \$1.75.

Van Reyper's Glazing Points—(Fig. 19). Simple and positive, no rights or lefts. Per 1,000, 60c; by mail, 75c. Pincers, 50c per pair; by mail, 60c.

Asparagus Buncher—(Fig. 14). \$3.25.

Asparagus Knife—Solid steel blade, 50c.

BASKETS

Picking Baskets—Half-bushel size. Price per dozen, without handles, \$3.50; with handles, \$4.50; drop handles, \$5.00.

White Oak Baskets—Side handles, 1 bushel, 75c each.

Rattan Baskets—With side handles, very strong. 1-bushel size, \$1.25; 2-bushel size, \$2.00.

Corn Barrels—With handles, \$8.50.

**FLOWER GUARD
and
TRELLIS WIRE**

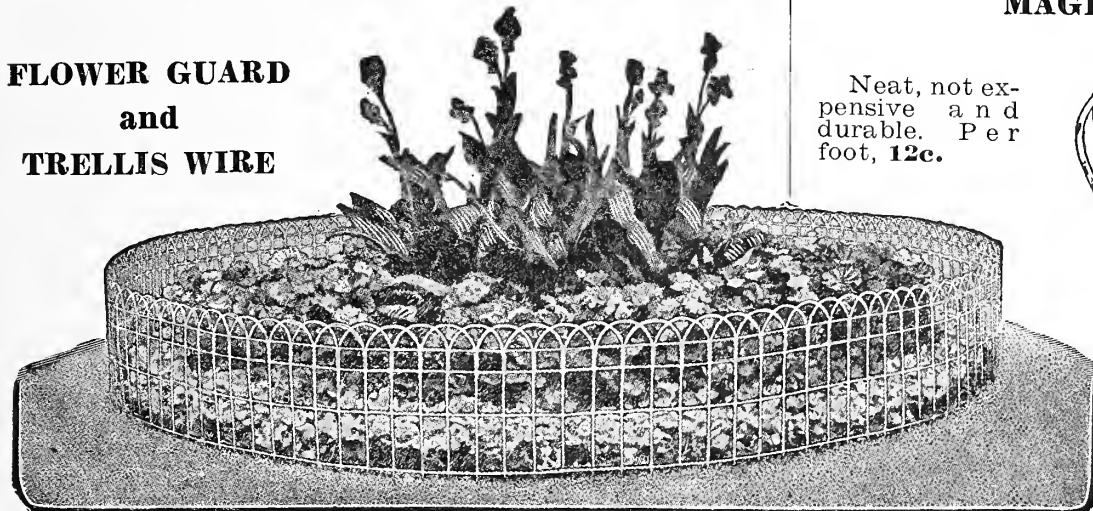

Neat, not expensive and durable. Per foot, 12c.

BRASS GARDEN SYRINGES

(Fig. 25)

No. A—One Spray Rose and Jet—12x1-inch barrel, \$3.50.

No. 2—Open Roses, Two Spray Roses and Jet—Side attachments, 14½x1 5-16-inch, \$5.00.

No. 5—Cone Valves, Two Spray Roses and Jet—Side attachments, 18x1½-inch, \$6.50.

Hand Sprinklers—(Fig. 20). Rubber bulb, with metal spray head. Small, \$1.25; large, \$1.50.

Fruit Picker—(Fig. 16). The best style, 50c.

Edging Knives—(Fig. 24). 8-inch, English, \$1.50; 9-inch, Handled American Edger, \$1.00.

Fodder Yarn—Price on application.

White and Yellow Pine Garden Boxes—Prices on application.

Garden Reels—(Fig. 18). \$1.00 and \$1.50.

Excelsior Hand Weeder—(Fig. 17). 20c.

Eurcka Hand Weeder—Very useful and strong, 40c.

Raffia—For tying plants. Per lb., 75c.

Tree Tubs—(Fig. 22). Cypress, painted green, iron-bound and iron feet. No. 1, 12-inch, \$2.50; No. 2, 13-inch, \$3.00; No. 3, 14½-inch, \$3.25; No. 4, 19⅞-inch, \$5.25; No. 5, 22-inch, \$6.50.

FLOWER POTS

3-inch—Per 100.....	\$1.60.	Per 1,000.....	\$14.50
3½-inch—Per 100.....	2.00.	Per 1,000.....	17.50
4-inch—Per 100.....	2.50.	Per 1,000.....	22.00
5-inch—Per 100.....	4.50.	Per 1,000.....	39.50

MAGIC "E-Z" WEEDER

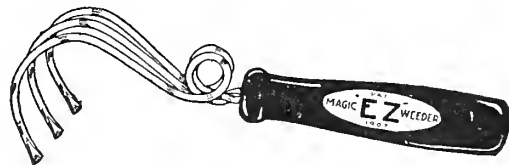

Light in weight, strong in construction. An excellent tool. Three-tine. Made of No. 8½ steel wire. Nicely trimmed. Black enameled handle.

Prices:

Small.....	20c
Large.....	35c

PLANET JR. HAND MACHINES Single-Wheel Hoes

SEE PRICE LIST BELOW

No. 12 PLANET JR. DOUBLE AND SINGLE-WHEEL HOE COMBINED

Packed weight, 33 lbs.
Equipment:
1 pair of 6-inch hoes.
4 steel cultivator teeth.
1 pair of plows.
2 leaf lifters.
All oil-tempered.

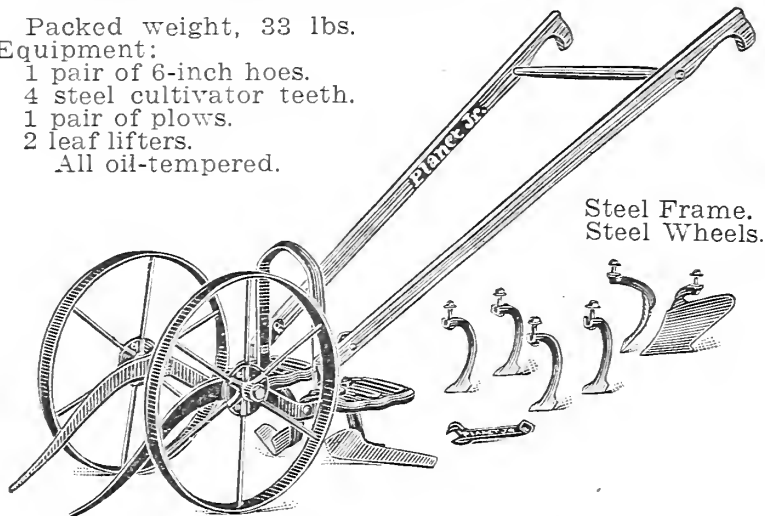

The No. 12 is the most popular Double-Wheel Hoe we make. It can be used by man, woman or boy. It is identical with No. 11, except that the 4½-inch hoes and the rakes are omitted from the equipment, and it is sold at a correspondingly less price. The attachments with it are what gardeners use most, and the short hoes, rakes and any of the attachments can be added at any time. You'll be astonished how easy it is to save time, labor, money and get bigger crops if you use it.

No. 19 PLANET JR. GARDEN PLOW AND CULTIVATOR

Weight, 21 lbs.
Equipment:
1 2-inch cultivating tooth.
1 10-inch sweep.
1 plow.
1 5-prong cultivating attachment.

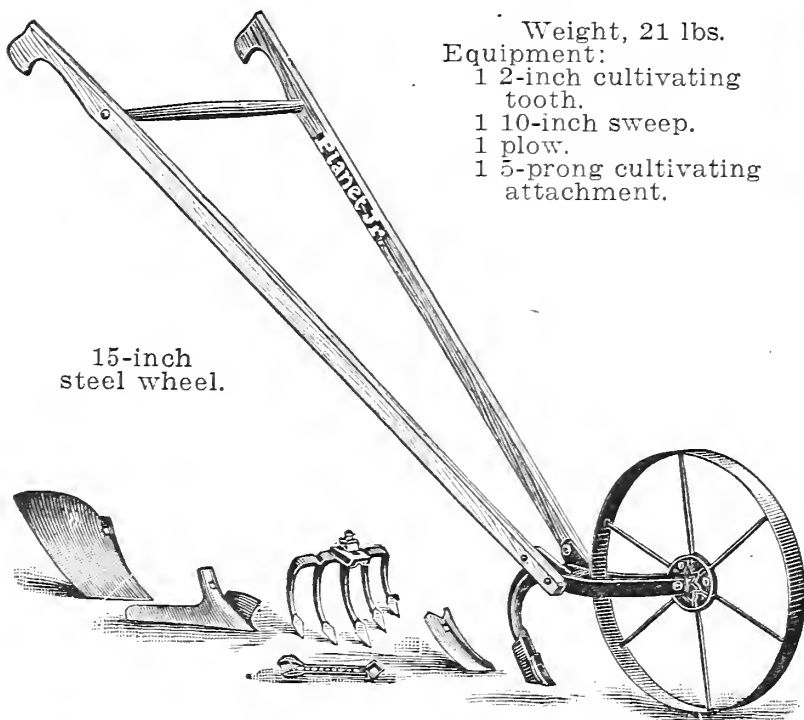

No. 19—This attractive implement is especially designed for the farmer's garden work, though it offers to every one with either field or garden a cheap and effective tool for wheel-hoe operations. The standard is slotted for depth regulation, and an adjustable piece carries any of the attachments that go with the machine. The cultivating tooth does deep work and marks out rows for onion sets, plants, etc. The sweep is fine for level shallow work. The five-prong cultivator attachment is bolted directly to the frame, first removing the S-37 standard. The plow marks out furrows, covers them and plows to or from the crop as wanted; opens furrows for fertilizer, peas, beans, etc. Use the five-prong attachment for deep and shallow cultivation. It will break up the ground and leave a mulch so necessary to preserve the moisture in the soil. The variety, shape and quality of the tools make the implement light-running and effective. It is strong, well made and quickly adjusted. The height of the handles can be changed to suit man or woman, boy or girl.

WHEEL HOES, GARDEN PLOWS, ETC.

No. 11....\$16.00	No. 16....\$10.25	No. 19....\$ 6.25
No. 12.... 12.50	No. 17.... 8.75	No. 39.... 10.00
No. 13.... 9.00	No. 17½.. 7.60	No. 39½.. 7.25
No. 14.... 14.00	No. 18.... 6.25	No. 60.... 6.00

No. 17 PLANET JR. SINGLE-WHEEL HOE

Packed weight, 24 lbs.
Equipment:
1 pair of 6-inch hoes.
3 steel cultivator teeth.
1 large garden plow.
All oil-tempered.

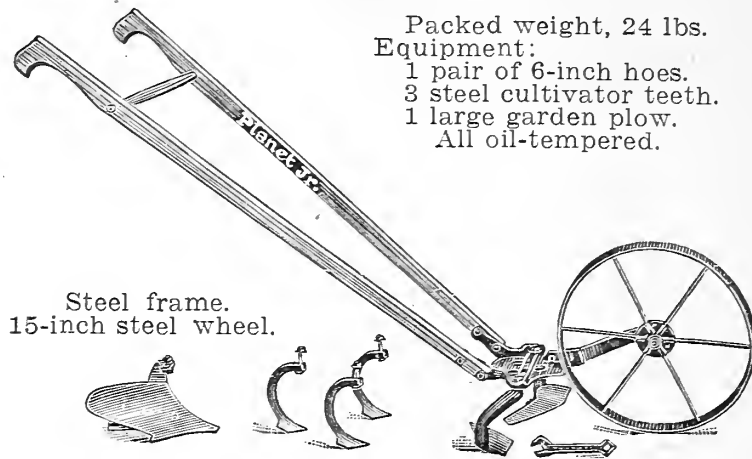

No. 17 is identical with No. 16, except in equipment, and all that has been said previously regarding Planet Jr. Wheel Hoes is equally true of No. 17. The three sets of attachments which go with it are all the finest of their kind, and make an outfit sufficient for most garden work. You can do more and better work with it in one day than you can do in several days with the old-fashioned hand hoe. The hoes exchange sides to work to or from the row, and change of wheel regulated the depth. The hoes are constantly useful throughout the season. The cultivating teeth are oil-tempered and work admirably, are changeable for pitch and are useful for marking out rows.

No. 119 PLANET JR. GARDEN PLOW AND CULTIVATOR

This new member of the "Planet Jr." family will appeal to all those who prefer a high-wheel tool for their garden work. Where the soil has not been so thoroughly and carefully prepared, the high wheel undoubtedly makes an easy-running tool. The wheel is 24 inches in diameter, with a rim 1½ inches wide, insuring easy running in the lightest soil. The equipment is so complete that it will meet all the needs of the ordinary

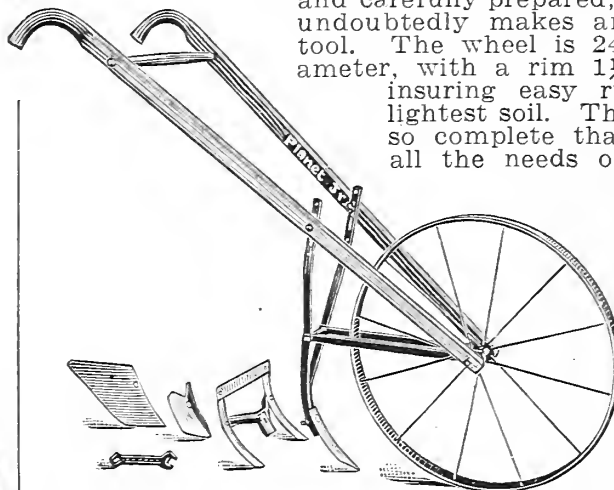

garden where the adjustments and refinements of the higher-priced wheel hoes are not required. The plow is the same as has been used for a number of years on our No. 19

Garden Plow and has proven most satisfactory. It may be used for plowing the ground in the Spring, going twice in each furrow. Later it will open furrows for fertilizer or for planting, covers them and plows to or from the crop during the season. The wide cultivator tooth may also be used for opening furrows or for cultivating and hilling between the rows of plants. Price, \$5.50.

FIRE-FLY GARDEN PLOW

This tool is exceedingly useful to owners of small gardens. It will throw a furrow 4 to 6 inches deep, and deeper by going a second time in each furrow. It makes fine furrows for manure or seeds and covers them, and makes up rows for all kinds of plant setting. In cultivating, plow away, weed the row and plow back again; nothing more thorough than this. After the furrow is thrown away from the crop lightly, leave it a few days before throwing back. This tool will enable a busy man to do in his spare minutes nearly all the work in a family garden. Chicken raisers find it of great advantage in plowing up their scratching yards. Packed weight, 14 lbs. Price, \$4.50.

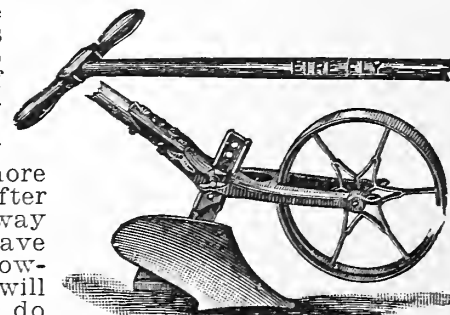

Cultivate The "Wisdom" Tomato With the Above Tools, (See Page 23)

No. 25 PLANET JR. COMBINED HILL AND DRILL SEEDER, DOUBLE-WHEEL HOE, CULTIVATOR AND PLOW

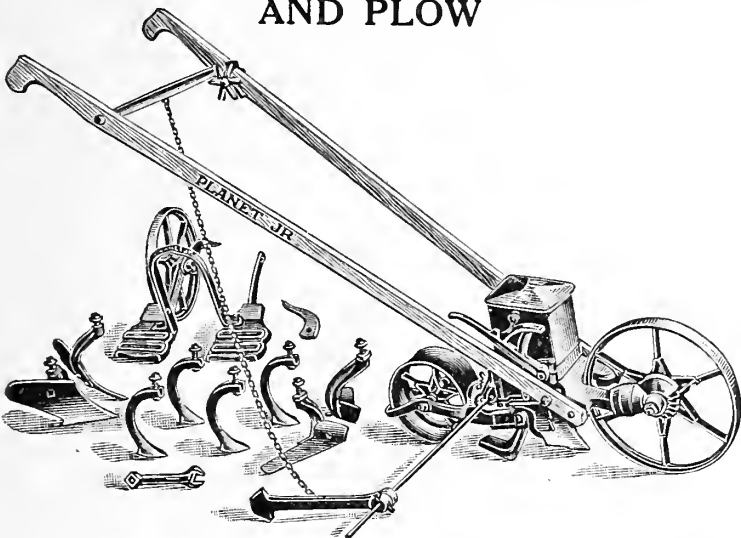

This new combined machine is intended for gardeners who have sufficient acreage in crops for a double-wheel hoe to be used to good advantage and do not want to buy separate machines. It can be used as a drill and is almost identical with the "Planet Jr." No. 4. It is thoroughly substantial and accurate in sowing all kinds of garden seeds in hills or drills. It has 11¼-inch wheels, and the hopper holds 2½ quarts. As a wheel hoe it is identical with the "Planet Jr." No. 12 Double-Wheel Hoe, the very best machine on the market. It takes but a moment to change from drill to wheel hoe, and the whole combination is one that we can heartily recommend and guarantee to be satisfactory. Price, \$23.00.

PLANET JR. No. 3 HILL AND DRILL SEEDER

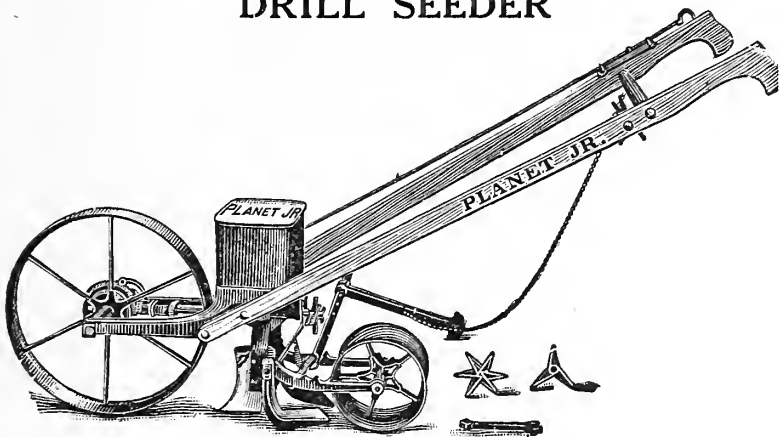

This Seeder is the latest and most perfect development of the hand seed drill. It sows evenly in drills and also drops in hills 4, 6, 8, 12 or 24 inches apart. It is thrown out of gear instantly by moving a convenient lever or the flow of seed is stopped by pushing down the feed rod. No time is lost, no seed is wasted; it is quickly set to sow the different kinds of seeds in the exact quantity required. We guarantee this drill to be accurate and to give satisfaction. The accuracy insures a regular stand of plants with the least seed, and the price of the drill is more than made up in the saving of seed. Holds 3 quarts. Price, \$18.50.

No. 5 PLANET JR. HILL AND DRILL SEEDER

This drill is identical in construction with the No. 3, but is larger. The hopper holds 5 quarts. It works very light and is intended for those having a great deal of planting to do. Price, \$15.50.

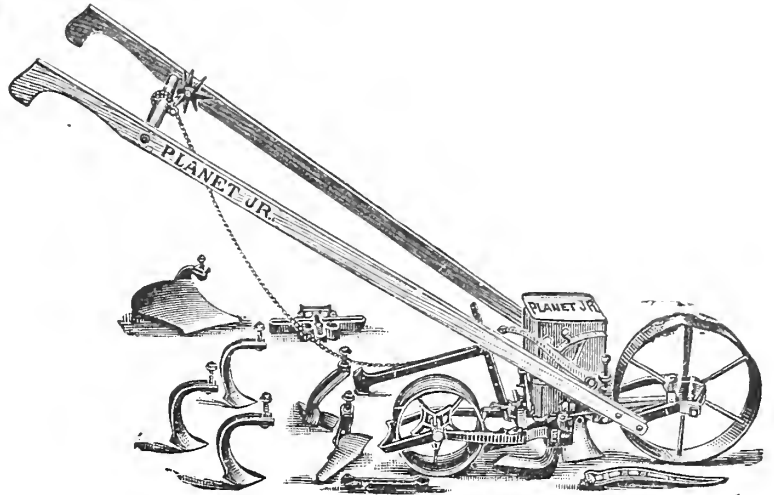

PLANET JR. No. 4 COMBINED SEED DRILL, SINGLE-WHEEL HOE, CULTIVATOR AND PLOW

This is the most popular combined tool made. It combines in a single implement a first-class hill-dropping seeder, a single-wheel hoe or weeder, a cultivator and a plow. The hopper holds 2 quarts of seed, which can be sown in continuous rows or dropped in hills at 4, 6, 8, 12 or 24 inches apart. Capacity of hopper, 2½ quarts. The drill is detached and the tool frame substituted by removing but one bolt. With this one implement the small farmer can do practically all the work in small crops. Price, complete, \$20.00.

The following are some of the seeds that may be planted with PLANET JR. SEEDERS:

- | | | |
|--------------|------------|------------|
| Apple | Okra | Peas |
| Asparagus | Onions for | Pepper |
| Beans | Bulbs | Pickle |
| Beets | Onions for | Radish |
| Cabbage | Sets | Rape |
| Cantaloupe | Parsley | Rice |
| Carrot | Parsnip | Ruta-Baga |
| Cauliflower | Pear | Sage |
| Celery | Ginseng | Salsify |
| Chicory | Kale | Savoy |
| Cucumber | Leek | Spinach |
| Endive | Lettuce | Sugar Beet |
| Field Peas | Mangold | Tobacco |
| Flower Seeds | Marjoram | Tomato |
| | Melon | Turnip |

PRICES OF SEEDERS

No. 1	\$16.00
No. 2	14.00
No. 3	18.50
No. 4	19.50
No. 4-D (plain)	15.50
No. 5	20.00
No. 25	23.00
No. 31	13.00
No. 31-D	10.50

THOMPSON'S CLOVER AND GRASS SEEDER

Sows 14 to 16 Feet Wide, Any Amount Desired Per Acre. Will Sow 20 to 25 Acres Per Day.

This Grass Seeder is simple, without gearing, cams or intricate machinery. It cannot get out of order.

Perfection feed is attained in making it absolutely positive, yet a non-leaking carrier, when thrown out of connection. The quantity of seed to the acre is accurately shown by the index plate.

It is strong, yet weighs but 40 pounds. No. 1—Complete Clover and Grass Seeder, the most popular style. 14-foot, \$13.60. 16-foot, \$14.55.

No. 5—Complete Seeder, with Double Hopper, sows Red Top, Orchard Grass, Blue Grass, Lawn Grass, as well as Clover. 14-foot, \$16.50.

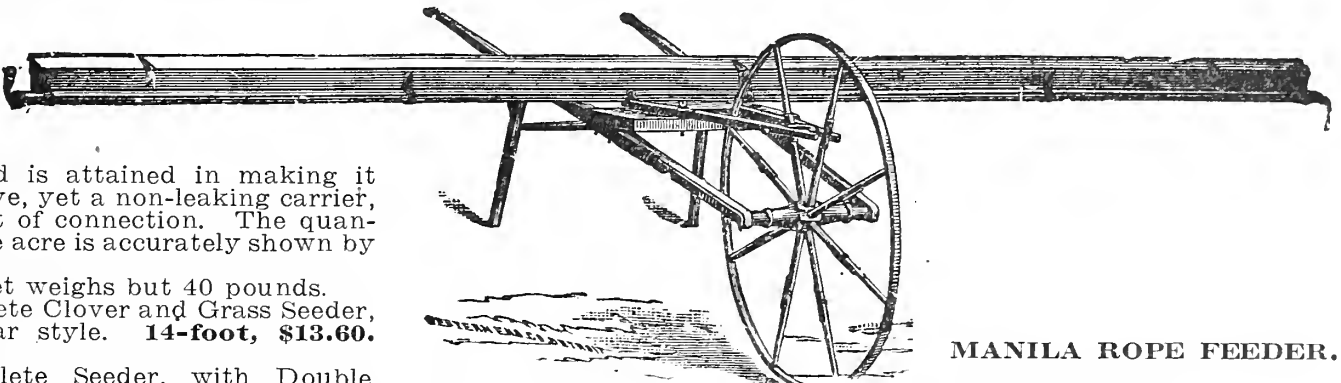

MANILA ROPE FEEDER.

14-foot, \$16.50.

No. 8 PLANET JR. HORSE HOE AND CULTIVATOR

This is the best and most perfect tool of its kind ever offered. Frame is of stiff steel, extra long and 1 or 2 inches higher than other makes. Closes to 9 and opens to 25 inches. Provided with patent depth regulator, lever wheel and improved lever expanding device, which combines great strength with stiffness and simplicity. This tool is the result of thorough knowledge of both farming and manufacture.

No. 7 PLANET JR. HORSE HOE AND CULTIVATOR

This tool is the No. 8 without the depth regulator. It works the same as No. 8, but lacks the perfect steadiness and control of depth made possible by the depth regulator.

No. 9 PLANET JR. HORSE HOE AND CULTIVATOR

Identical with the No. 8, except that it has no depth regulator, and plain wheel instead of lever wheel.

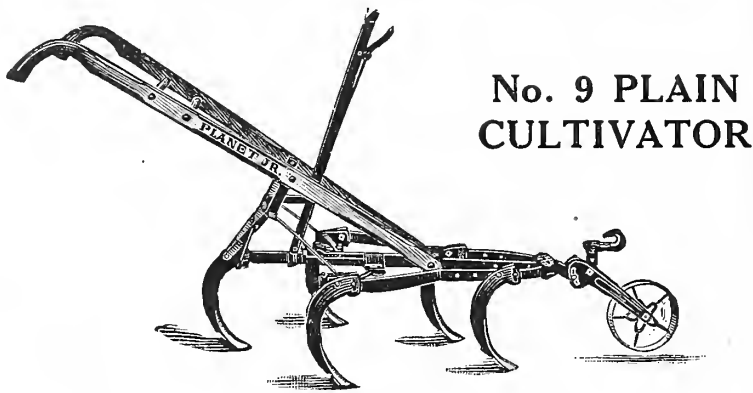
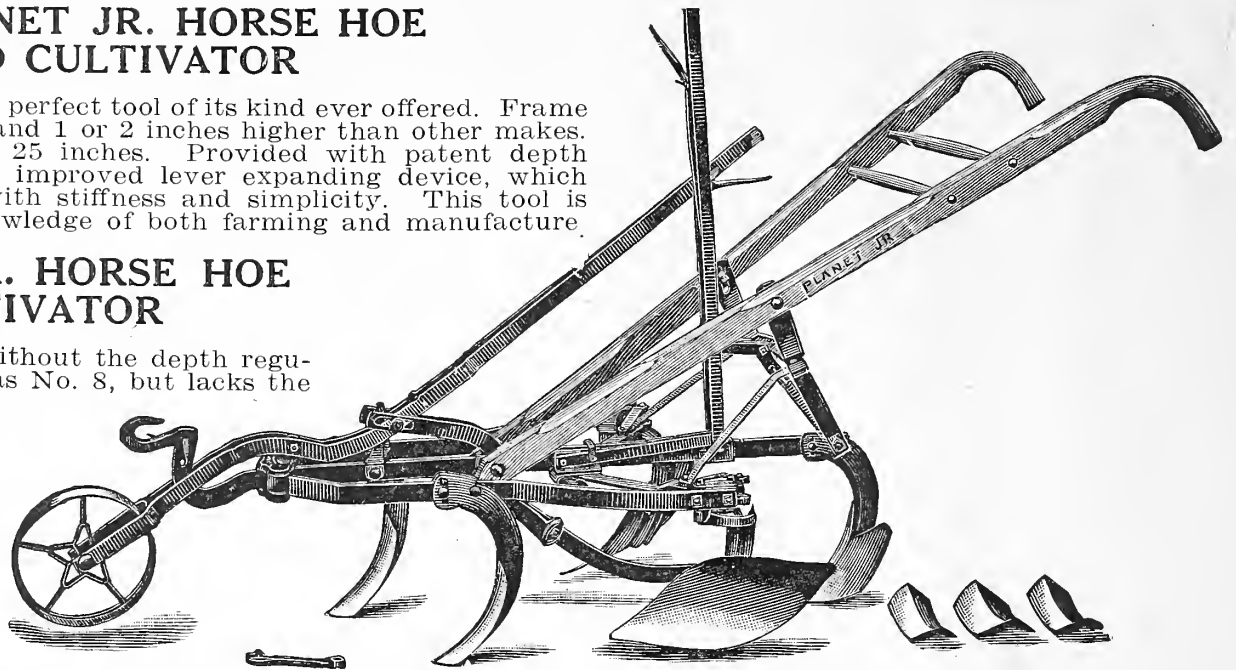

No. 9 PLAIN CULTIVATOR

PLAIN CULTIVATORS

No. 4, with wheel.....	\$12.50
No. 4-D, no wheel.....	10.25
No. 9, with wheel.....	15.00
No. 9-D, no wheel.....	12.75
No. 83, with wheel.....	16.75
No. 83-D, no wheel.....	14.50
No. 100, with wheel.....	10.50
No. 100-D, no wheel.....	8.75
No. 101, with wheel.....	12.50
No. 101-D, no wheel.....	12.75
No. 107, with wheel.....	15.00
No. 107-D, no wheel.....	13.25

No. 4 PLAIN CULTIVATOR

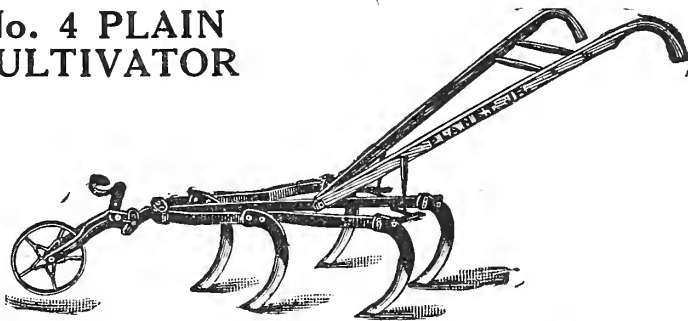

This popular tool, as illustrated, has been stiffened and improved by new patent braces and expanders. Furnished either with or without wheel. This is an excellent Cultivator.

14-TOOTH COMBINED HARROW AND CULTIVATOR

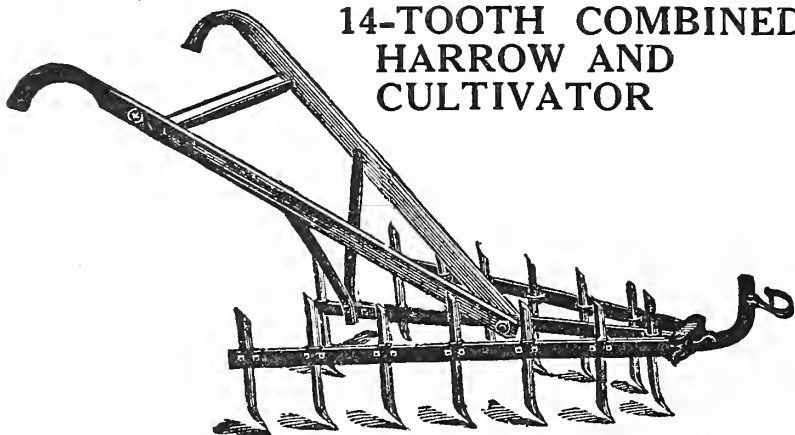

This is a very useful tool, which can be made to do a variety of work. The teeth are set in different positions. Desirable for first cultivation. Price, plain, \$8.00; with lever, \$9.00.

PLANET JR. 12-TOOTH HARROW, CULTIVATOR AND PULVERIZER

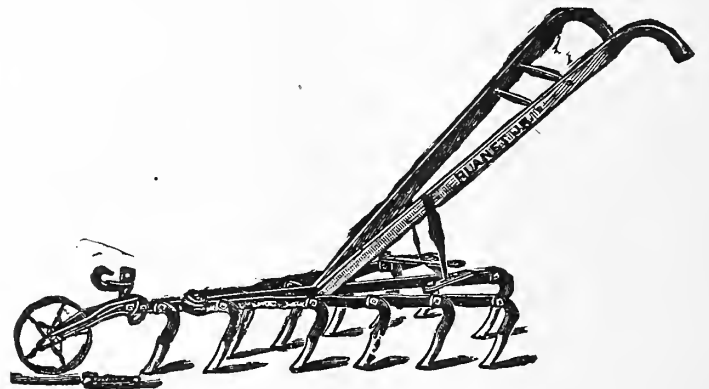

This tool has rapidly grown in favor among strawberry growers, market gardeners, truckers and farmers. This is because the 12 chisel-shaped teeth do such thorough work, and at the same time do not throw the earth on small plants, and because the tool is so convenient, durable and strong. With this tool you can do such a fine grade of work, and such a variety, that it is really a very valuable tool, and it will be to the interest of farmers to send for catalogue fully describing it. Price, complete, \$20.00; with wheel, \$12.75; plain, \$10.50.

No. 4 PLANET JR. HORSE HOE

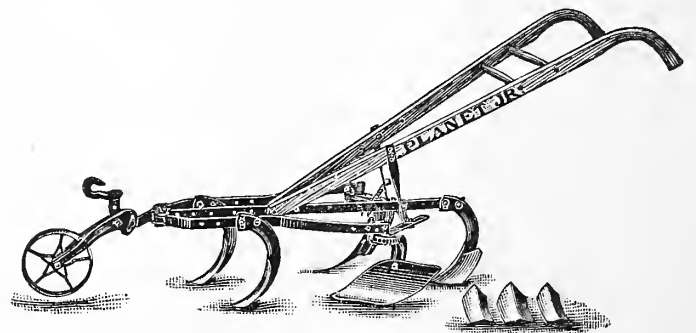

This tool is low in price, strong and simple; provided with patent handle braces; firm, simple, strong, convenient. With these, the frame and handles seem almost like one solid piece. Changes in width are very quickly and easily made by the patent expanders, and one side may be opened wide and the other closed. Furnished with or without wheel.

HORSE HOES.

No. 4, with wheel.....	\$15.00
No. 4-D, no wheel.....	12.75
No. 7.....	18.50
No. 8.....	19.50
No. 9, with wheel.....	12.00
No. 9-D, no wheel.....	14.75
No. 80, with wheel.....	18.50
No. 82, with wheel.....	19.00
No. 82-D, no wheel.....	16.75
No. 104, with wheel.....	15.00

THE FOWLER CULTIVATOR

The most serious problem confronting the American farmer today is how to increase his production, in the face of a universal labor shortage, sufficiently to meet the unprecedented demand for every product of the farm.

The Fowler Cultivator is doing more to successfully solve this problem than any other one-horse implement. As a labor-saver alone, making possible the cultivation of eight or nine acres per day with one horse, the Fowler is worth many times the price asked for it; but its greatest value to the farmer is the increase in production which its use insures. This increase in production is obtained because the perfect dust mulch developed and maintained by the Fowler conserves all moisture and plant food and because where this Cultivator is used the roots of the growing crop are undisturbed.

The United States Department of Agriculture is urgently advocating the principle of shallow cultivation as a means of increasing production, and the work done by the Fowler Cultivator is in perfect accord with the recommendations of the department in this regard, while the wonderful results obtained by its use demon-

strate beyond question not only the soundness of this principle, but the great value of the tool itself.

The Fowler can be run as shallow as 1½ inches, and so is used much later in the season than other cultivators, because, like the hoe, it works above the crop roots. This late cultivation contributes very largely to the early and complete maturity of the crop, which is so much desired.

In wet weather the Fowler can be used very soon after a rain, because it can be run so close to the surface that it is possible to cultivate successfully with it just as soon as the ground has dried off a little. This circumstance, and the fact that it covers so much ground in one day, making only one trip to the row, makes it possible to keep grass and weeds under control much easier than with other tools.

The blades of the Fowler are made from the best grade of high carbon plow steel and are very hard and keen. They can be sharpened with a coarse file, on an emery wheel or can be drawn out by any good blacksmith. The blacksmith should have as a pattern or template an extra pair of blades which have the correct shape. **Price, \$16.00.**

IRON AGE

To those who desire a Cultivator a little lighter and lower-priced than the "Planet Jr." we offer this one as a thoroughly reliable tool, from the standpoint of construction and material as well as working qualities. Price of Plain Cultivator..... **\$7.00**
Horse Hoe attachments..... **2.50**

BENT FRAME CULTIVATOR

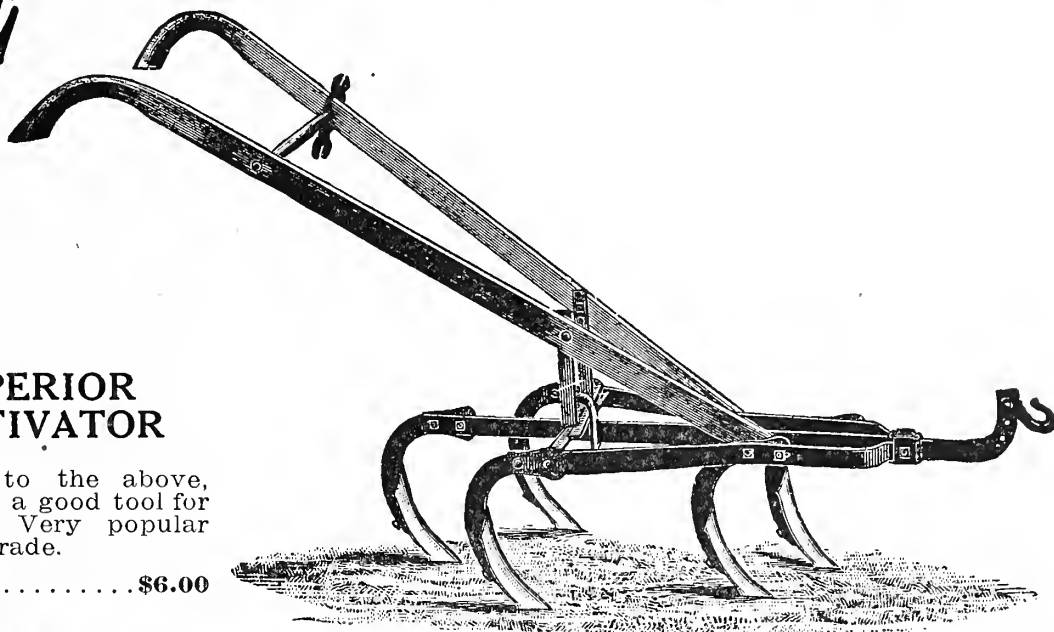

SUPERIOR CULTIVATOR

Similar to the above, but lighter; a good tool for light soil. Very popular with our trade.

Price..... **\$6.00**

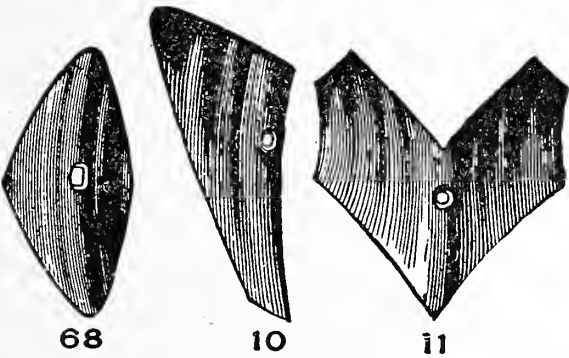
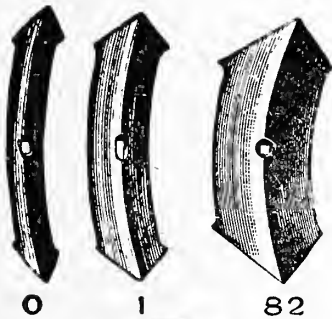

IRON AGE CULTIVATOR POINTS AND EXTRAS

No. 0—1¼ inches wide. Each	\$0.14
No. 1—2 inches wide. Each15
No. 82—3 inches wide. Each18
No. 68—Oval or Jersey. Each20
No. 10—Turn Shovels, either right or left-hand. Each45
No. 11—Turn Shovels, 6 inches wide.60
Horse Hoe Steels, right or left. Each70
Levelers for Cultivators.....	1.50
Wheels for Cultivators.....	1.50
Cultivator Plate Bolts.....	.05
Cultivator Frame Bolts.....	.05
Cultivator Handles. Per pair.....	1.75
Teeth for Combined Harrow.....	.25

GENUINE PLANET JR. EXTRAS

	Price.	Weight Lbs. Oz.
1¼ x 8-inch Steels.....	\$0.18	11
1¾ x 8-inch Steels.....	.21	11
2¼ x 8-inch Steels.....	.24	12
3 x 8-inch Steels.....	.28	14
4 x 8-inch Steels.....	.34	1 2
10-inch Steels fit all Planet Jr. Two-Horse Cultivators, excepting No. 72.		
1¼ x 10-inch Steels.....	\$0.24	13
1¾ x 10-inch Steels.....	.26	14
2¼ x 10-inch Steels.....	.32	1
3 x 10-inch Steels.....	.40	1 1
4 x 10-inch Steels.....	.44	1 8
1¾ x 9-inch Alfalfa Teeth and Bolt.....	.40	1 2
Shovel Steels fit all Planet Jr. One and Two-Horse Cultivators.		
7-inch Shovel Steel.....	\$0.40	1 9
8-inch Shovel Steel.....	.44	1 12
Hillers and Plows fit all Planet Jr. One and Two-Horse Cultivators, excepting Twelve-Tooth Harrow.		
6-in. Hillers. Per pair.....	\$1.50	4 10
7-in. Plows. Per pair.....	1.75	5 2

Regular Sweeps fit all Planet Jr. One and Two-Horse Cultivators.		
	Price.	Weight Lbs. Oz.
6-inch Sweep.....	\$0.45	14
8-inch Sweep.....	.48	1 4
10-inch Sweep.....	.55	1 6
12-inch Sweep.....	.60	1 9
15-inch Sweep.....	.75	1 14
18-inch Sweep.....	.95	2 2
24-inch Sweep.....	2.00	2 13
Per Pair.		
8-inch 1-Sided Sweeps.....	\$1.10	2 4
9½-in. 1-Sided Sweeps.....	1.25	2 8
11-inch 1-Sided Sweeps.....	1.40	2 12
Irrigation Steels and Turning Shovels fit all Planet Jr. Cultivators.		
Irrigation Steel.....	\$1.60	4 2
Per Pair.		
6-inch Turning Shovels.....	\$0.80	3
5-inch Turning Shovels.....	.70	2
7-inch Turning Shovels.....	1.20	4

Hoe Steels fit Planet Jr. Horse Hoe Side Standards.		
	Price.	Weight Lbs. Oz.
6-in. Hoe Steel & Bolt.....	\$1.40	2 10
10-in. Hoe Steel & Bolt.....	1.75	3 12
Beet Hoe Steels fit Planet Jr. Two and Four-Row Beet Cultivators and Twelve-Tooth Harrows.		
Per Pair.		
5-in. Beet Hoe Steels.....	\$1.25	2 6
6-in. Beet Hoe Steels.....	1.40	3 4
7-in. Beet Hoe Steels.....	1.40	3
Improved Flat Sweeps fit all Planet Jr. One and Two-Horse Cultivators Standards, excepting Horse Hoe Side Standards.		
3-in. Imp. Sweep & Bolt...	\$0.45	14
5-in. Imp. Sweep & Bolt...	.50	15
8-in. Imp. Sweep & Bolt...	.60	1 6
10-in. Imp. Sweep & Bolt...	.70	1 10
12-in. Imp. Sweep & Bolt...	.80	1 14
15-in. Imp. Sweep & Bolt...	.90	2 5
18-in. Imp. Sweep & Bolt...	1.20	2 10
24-in. Imp. Sweep & Bolt...	2.50	3 3

The New No. 77 Planet Jr. Pivot Wheel Cultivator

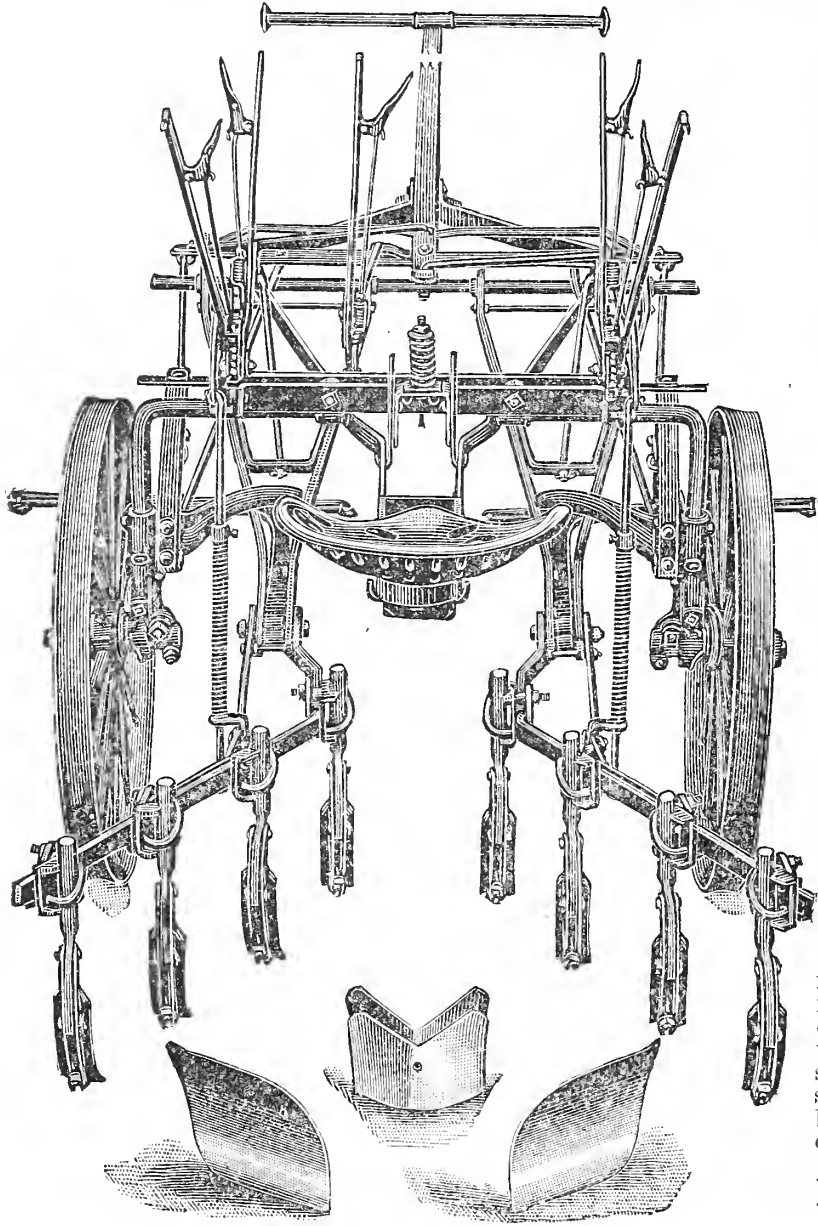

The No. 77 Pivot Wheel Riding Cultivator is new for 1922 and although not perfected until late last season field trials demonstrated its many improvements over any other similar cultivator. Briefly these consist of a clear view of the row in front of the Wheel Axle frame and a better view behind this frame between seat bars; gangs are raised without pulling back against the team. Gang lifting levers are in a more convenient position and the gang is lowered and spring compressed by one motion. Front end of gang is adjusted separately, a lever for each gang. Tongue is rigid with the frame at all times making the frame always practically level. There are a number of other minor improvements which make this the best all round one row riding cultivator. It is made almost entirely of steel and castings where absolutely necessary are malleable.

Price Complete, \$90.00. No. 77-D Plain, \$84.25.

No. 76 PLANET JR. PIVOT-WHEEL RIDING CULTIVATOR, PLOW, FURROWER AND RIDGER

The No. 76 is a comparatively new implement which combines in itself nearly all the practical advantages possible in one tool, and is a grand tool for every farmer who cultivates anywhere from ten to hundreds of acres. The extra-wide arch is 34 inches high, and will work corn safely up to 4 feet. The frame and tongue are steel. The pivot wheels change in width easily, to suit all rows from 28 to 48 inches, and they make guiding a pleasure. The gang frames are extra heavy, but improved levers with lifting and depth-regulating springs make their perfect control easy. The new levers and springs regulate the depth and pressure of the teeth. The central lever operates the hinged tongue, regulating the depth of the front teeth and leveling the machine; the same lever moves the teeth instantly, either closer to or further from the row, as desired, while the team is in motion. All parts are steel except a small percentage of malleable iron. All teeth are specially hardened. Improved spring lifting levers make control of the gangs rapid and easy. The tool works rows from 28 to 48 inches apart, cultivating, plowing or hilling. It marks out rows from 24 to 48 inches apart, 2 at once, and with the plows will cover or make up drills ready for seed sowing or for planting. This cultivator is simple, roomy, strong and easily handled. Every part is made of the best material in the best manner, and is of the finest quality, design and finish. No. 76B, \$87.75.

INTERNATIONAL No. 4 CULTIVATOR, BALL-BEARING PIVOT AXLE

International No. 4 Pivot-Axle Cultivator can be adjusted from deep to shallow, wide to narrow, cultivation without leaving the seat. It is equally good in corn, potatoes, beans, peas or beets. A boy who can handle a team can do clean cultivating work with International No. 4 because the axles pivot on steel balls and the gangs shift on rollers. The cut shows our Eight-Shovel Spring Hoe Cultivator. Price, \$50.00.

International No. 4 Pivot-Axle Cultivator equipped with 8 double-point trip-slotted shanks. This style is very practical in the Eastern States, or wherever beans, peas, beets and potatoes are raised. We can also furnish a Fertilizer Attachment for this Cultivator.

IRON AGE FERTILIZER ATTACHMENTS

No. 78 RIDING CULTIVATOR EQUIPPED With No. 578 FERTILIZER DISTRIBUTOR

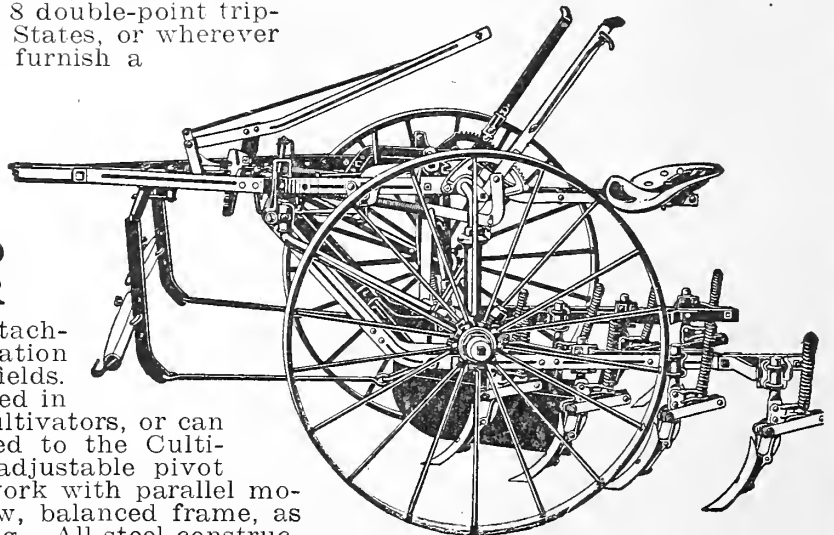

A new and important attachment that combines fertilization and cultivation in your fields. This attachment can be applied in our Nos. 68 and 78 Riding Cultivators, or can be purchased already attached to the Cultivator. The Cultivator has adjustable pivot gangs (patented) that work with parallel motion in any width of row, balanced frame, as light, compact and strong. All steel construction, high or low wheels, dust-proof bearings, etc. With this attachment a quick-acting fertilizer can be thoroughly mixed with the moist soil when the crop is cultivated. With high-priced fertilizers this method is especially desirable as smaller quantities are required, and there is less likelihood of leaching from heavy rains. Masses of fertilizer are not permitted to form, and there will be no layers of fertilizer under the plants which cannot be stirred up to make the plant-food available. By the use of this new Fertilizer Attachment and a pair of discs, the Cultivator becomes a practical row maker, making up and fertilizing rows for plants such as strawberries, cabbage, peppers, tomatoes, etc. The hopper holds 80 pounds of fertilizer. The feed is practically the same as that used on the Iron Age Potato Planter so successfully for many years. The feed-spouts are adjustable, and can be regulated to suit the width of rows.

Price, \$55.00; With Fertilizer Attachment, \$80.00.

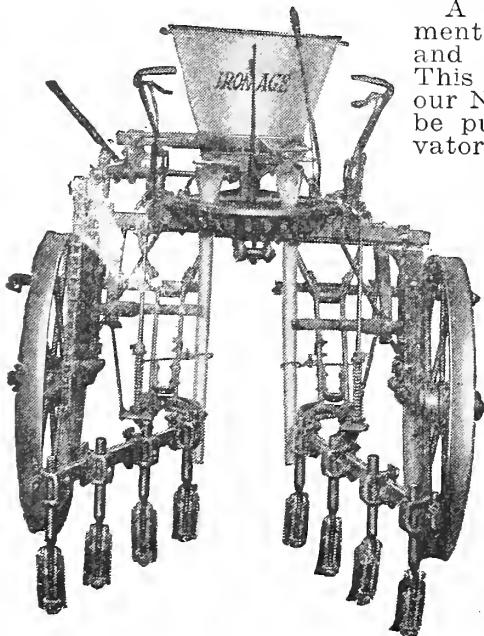

See Page 23 For "Wisdom" Tomato

McCORMICK PEG-TOOTH HARROW

Two-Section McCormick Peg-Tooth Harrow, Having 30 Teeth to a Section.

This harrow is built in sections with 25, 30 or 35 teeth to the section, either 1/2-inch square or 5/8-inch diamond-shaped teeth.

The McCormick Peg-Tooth Harrow is unusually strong for its weight. One reason for its great strength is that there are 2 stiffening bars in each section. The effect of these stiffening bars is to transmit any bending force which may come on a tooth beam to all of the other tooth beams in that section, making them all act together to resist bending. Thus it is practically impossible in ordinary work

to bend a tooth beam on a McCormick Peg-Tooth Harrow. The tooth beams are very strong and are made of channel bar, thicker in the center than at the edges—a form which offers great resistance to twisting.

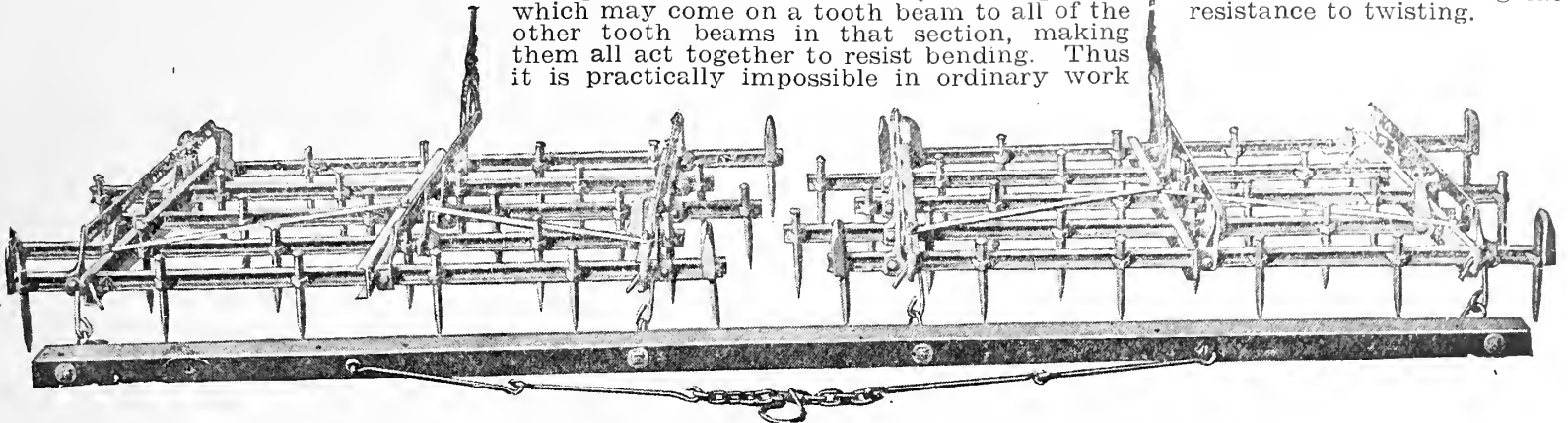

Three-Section McCormick Rigid Peg-Tooth Harrow—Teeth Are Securely Held.

The teeth are held to the tooth bars by special steel clips which fit closely around the teeth, holding them into small notches in the edges of the tooth bars. These tooth clips are then drawn up tightly by means of two nuts which prevent them from working loose and make it practically impossible for a tooth to twist around, drop out and become lost. Each of the steel teeth is complete in itself, well made, with a head formed at the top so that the tooth cannot drop through the clip. Four runner teeth are furnished with each section, and are used as transports when moving the harrow from one field to another, making it unnecessary to take the implement down and load it on a wagon.

50-Tooth 5/8 Spikes Harrow.....\$20.00 60-Tooth 5/8 Spikes Harrow.....\$22.00
90-Tooth 5/8 Spikes Harrow.....\$35.00

McCORMICK SPRING-TOOTH HARROW

McCormick Spring-Tooth Harrows are valuable in any kind of soil. They are particularly useful when the Spring is late and cold and the ground refuses to warm up. The springy, lifting action of the teeth loosens the soil, distributes the air through it and permits the warm rays of the sun to permeate to a great depth, thereby giving the crop a much-needed boost. The construction of McCormick Spring-Tooth Harrows is light, but very strong for use under rough field conditions. The teeth are made of high-grade steel and will not straighten out. There are no holes in the teeth. They attach to the tooth bars by means of a clip and two nuts. Double-pointed teeth can be obtained on special order when the ground is hard or stony, or wherever there is extraordinary wear. We urge you to see and examine a McCormick before deciding on any particular make.

McCormick Spring-Tooth Harrows are built in 1, 2, 3 and 4-section sizes. One-section harrows can be had with 7, 9 and 12 teeth; 2-section 3-section with 23, 25 and with 15, 17 and 23 teeth; 35 teeth; 4-section with 31 and 33 teeth.

Prices on Spring-Tooth Harrows:

15-Tooth.....\$23.50
17-Tooth..... 25.00
23-Tooth..... 35.00
25-Tooth..... 37.00

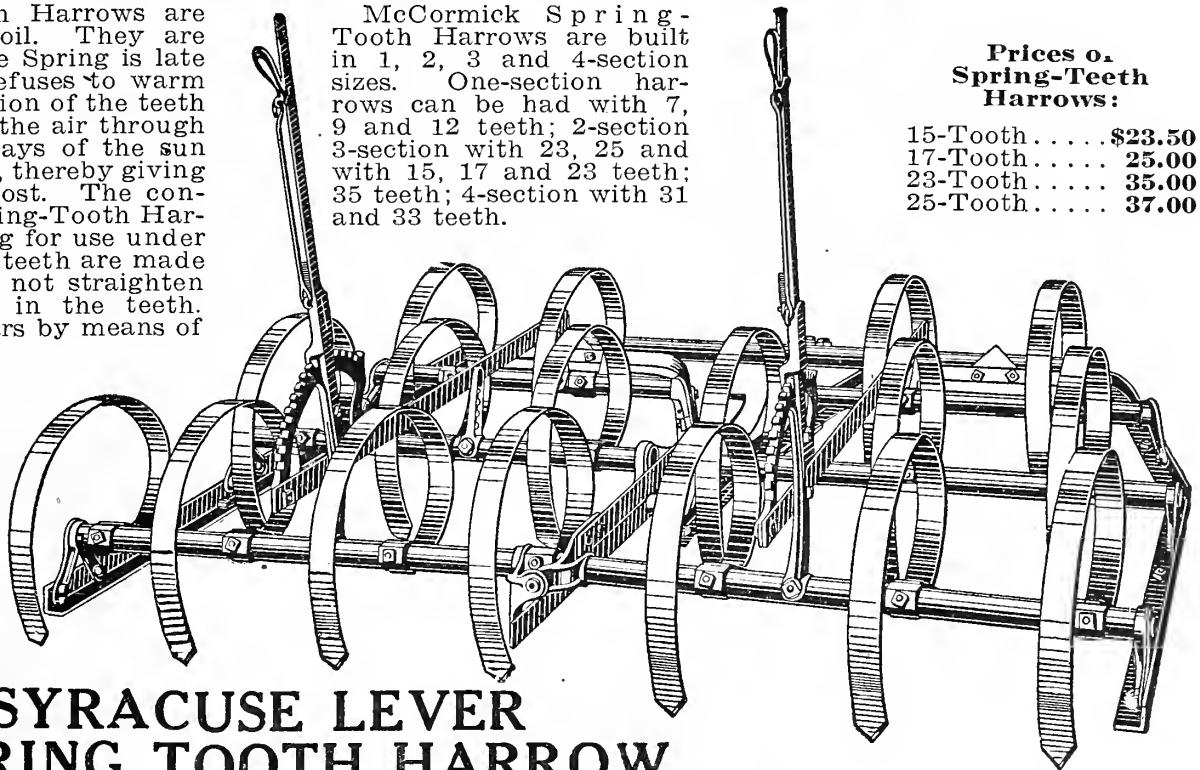

SYRACUSE LEVER SPRING TOOTH HARROW

The frame bars of angle steel, thoroughly protected by steel shoes, which double the life of the harrow. Inside frame bars raised at the end, giving free outlet to trash. Frame with small opening in front, absolutely preventing loading at this point, which is so common with other makes. The

tooth bars are of channel steel, journaled in malleable brackets above the frame, which gives the teeth high support and great range of adjustment for depth of cultivation and clearance. Spring teeth of high carbon steel, without

bolt holes, and held by malleable holders, allowing for separate adjustment when worn. By use of the levers the teeth can be readily set deep or shallow, or can be thrown out of the ground to clear off trash and for dragging harrow from one place to another. Central and direct draft without side

motion; adjustable hitch, so that the teeth at the front and rear can be regulated to work at the same depth. No spring-tooth harrow made is giving such universal satisfaction.

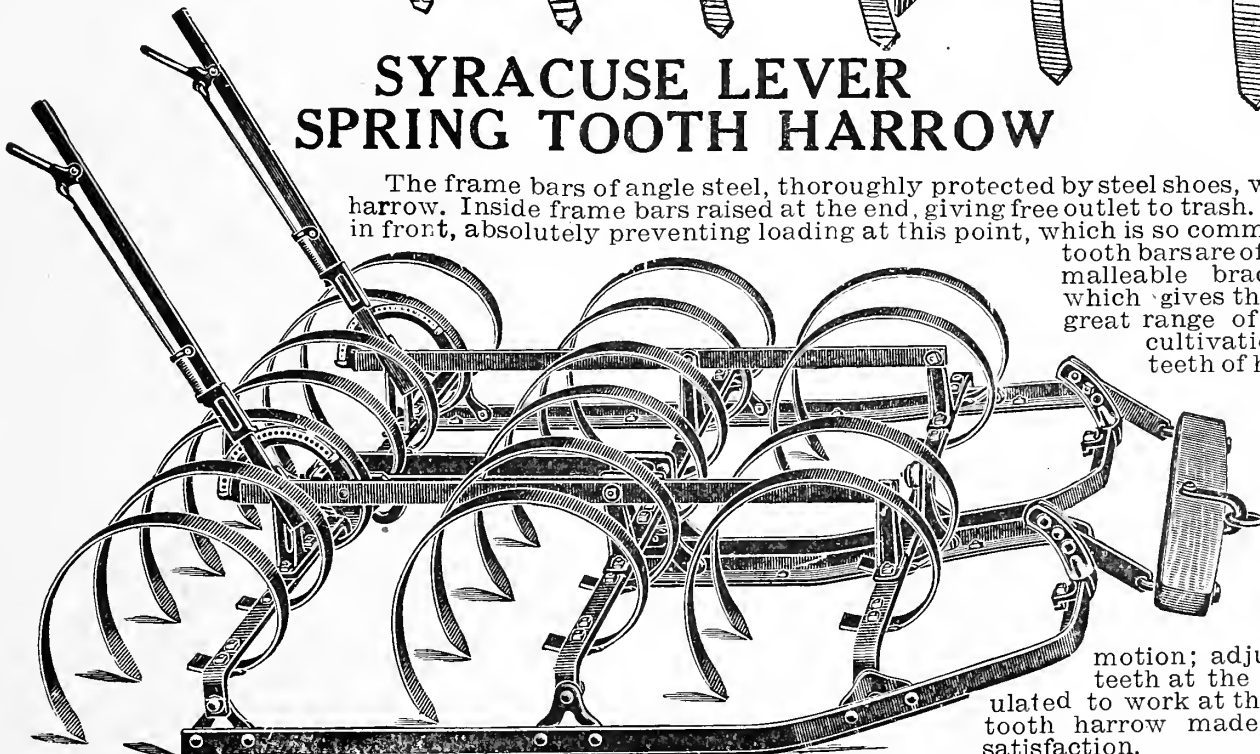

Prices: 15-Tooth, \$24.50; 23-Tooth, \$36.00; 17-Tooth, \$26.00; 25-Tooth, \$38.00.

McCORMICK TILLAGE IMPLEMENTS

**This Is the Regular McCormick 8-Foot Disk Harrow.
You Simply Can't Beat It for Good Field Work**

MADE IN ALL SIZES OF DISC, 16, 18 AND 20 INCH

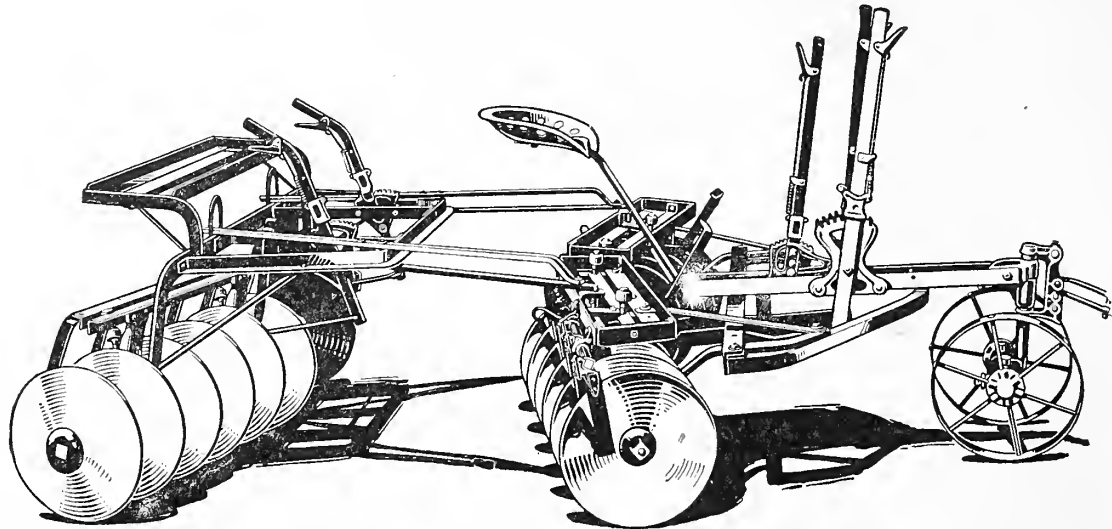

The McCormick 8-Foot Disk Harrow With Sixteen 16-Inch Disk Blades

A McCormick Tandem Disk Harrow Leaves the Seed Bed in Ideal Condition to Receive and Nourish the Seed—It Almost Insures a Bumper Crop

If you have never used a Tandem Disk Harrow, by all means do so this year. It results in a much better job than can be obtained with a single harrow, even when you lap half. The McCormick Tandem Attachment can be ordered to fit any McCormick Disk Harrow and is equipped with solid disk blades. Two draft arms pull from the front corners of the Tandem Attachment at opposite angles. This holds the tandem rigidly in line while working and prevents the tandem blades from tracking the front harrow. At the end of the field, or

when making a turn these draft arms telescope backward, permitting both front and rear harrows to curve sharply without twisting the frame or sliding the gangs. A strong steel arch resists the effect of the soil against the blades and the bearings are specially constructed to offset end thrust. An angle steel weight box will be supplied on special order at slight cost, where it is necessary to use extra weight to get sufficient penetration. Ordinarily added weight is not necessary.

Prices Complete With Fore-Carriage

8-16.....	\$82.50
10-16.....	88.00
12-16.....	98.00

McCORMICK 2 OR 3 HORSE DISC HARROWS

MADE IN 16-IN., 18-IN. AND 20-IN. DISKS

The first thing you notice about the McCormick Disk Harrow is its simplicity. There are no bulky or cumbersome parts, no awkward toggle joints nor hinges. Its makers have worked hard for rigidity and durability because it is upon these two qualities that a good disk harrow depends for satisfactory work. In the illustration above observe the clean lines of construction. The one-piece angle steel frame extends from one end of the harrow to the other without a joint. The steel stub tongue is a backbone that holds the frame and gangs in rigid alignment. Angle steel weight box is built in and always ready when needed. Gray iron standards add rigidity to the gangs and do away with long hard oil pipes, because hard oil runs through the standards

directly to the bearings. Oscillating scrapers clean the disk blades with a single motion of the feet.

PRICES:

McCormick Two-Lever Disk Harrow

8-16.....	\$38.00
10-16.....	41.00
12-16.....	43.00

McCormick Three Levers

8-16.....	\$40.00
10-16.....	43.00
12-16.....	45.00

INTERNATIONAL LEVERLESS TRACTOR DISK HARROW

Every man who owns a tractor wants to use it for every farm task. The tractor that is busy every day pays a bigger profit than one that stands idle half the time.

Because the tractor is stronger and will do a better job of disking than horses, it follows that the disk harrow must be built correspondingly heavier and stronger. Therefore, a demand has grown up for a strong, substantial disk harrow designed especially for use with light farm tractors. The International Leverless Tractor Disk Harrow is the answer.

The most striking feature of the International Leverless Disk Harrow is the fact that it is operated from the tractor entirely without the use of levers, yet it is just as closely controlled as any lever disk harrow. The operation is very simple.

To secure proper angle the operator backs his tractor, which automatically sets the gangs of both front and rear harrows. He then starts to work, and the gangs assume whatever angle has been given time.

Send for Special Catalogue and Prices.

SYRACUSE WOOD BEAM CHILLED PLOWS

We show on this page an illustration of the leading series of the Syracuse Wood Beam Chilled Plows. This plow has chilled wearing parts, has sloping landside and leaves a clean, open furrow. It is excellently adapted for general-purpose work in all kinds of soil. This plow will do satisfactory work in hard ground when other makes fail. It is easily handled, and the style of the beam, clevis, wheel and jointer is such that the adjustment is easy and accurate. The wheel and jointer standards are wrought steel and will never break. Note that there is plenty of room between jointer standards and plow standard, so that there is no choking. Remember that Syracuse Plows are guaranteed to do work equal to any plow on the market.

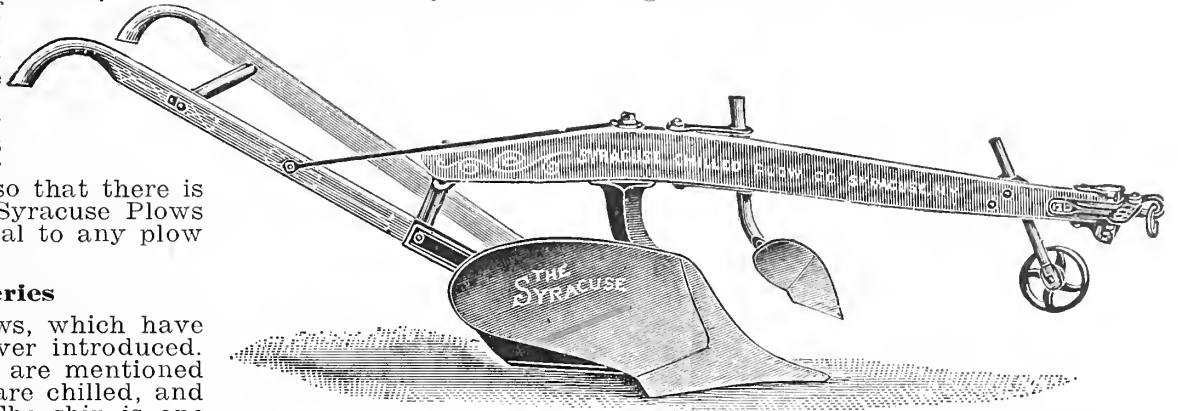

The 500 and 600 Series

This is a later series of Plows, which have gained great popularity wherever introduced. It includes the numbers which are mentioned below. All the wearing parts are chilled, and they have sloping landside. The shin is one piece, with the share so that you have a new shin whenever you put on a new share. We believe that this series is destined to become the most popular of all.

Prices are for Plows Complete as Shown in Cut.

Right Hand.	Left Hand.	Size,	Furrow.	Weight.	Price.
No. 601	No. 501	—Large, Two or Three-Horse...	5½-8 ins. deep, 12-16 ins. wide...	127 lbs.	\$25.75
No. 602	No. 502	—Medium, Two-Horse.....	5 -7 ins. deep, 11-14 ins. wide....	99 lbs.	24.75
No. 603	No. 503	—Light, Two-Horse.....	4½-6½ ins. deep, 10-12 ins. wide....	99 lbs.	23.75

No. 1-78 HEAVY, or CONTRACTOR'S PLOW

Similar to the No. 1-78, except that the wearing parts and beam are heavier, and it has two heavy iron braces running from the curve of the beam to the handles. This is an excellent plow for general grading purposes. It turns the same furrow as the regular No. 1. **Send for Prices.**

GENUINE SOUTH BEND X SERIES CHILLED PLOWS

The South Bend Chilled Plow is widely copied. Be careful, therefore, to demand the genuine, the one that has created a world-wide reputation on its merits.

X Series Plow With Rolling Coulter and Wheel

Get a genuine South Bend Chilled Plow of your dealer with the understanding it is on trial. Give it the hardest kind of test; compare it in actual operation with any other; keep a record of the amount of first-class work; compare lightness of draft; note how steady it runs and how easy to handle; how well it scours and how little wear. If you are not perfectly satisfied, say so to your dealer. He guarantees the plow, and we are back of him.

We Want to Impress These Facts Upon Your Mind
FIRST—The Chilled Metal of which the Genuine Chilled Plows are manufactured is superior to any material ever used heretofore by any plow manufacturer in plows.

This metal is made under Letters Patent, and has no equal for wear and scouring. By our process we entirely change the nature of the iron, making it in texture as fine as the finest steel, upsetting the grain, throwing it endwise through the mould-board, landside or share, making the wear come the same as the wear across the end of a

plank, instead of lengthwise of the grain, as with all material used by other plow makers.

SECOND—The share is such as to give light draft and insure excellent work, lifting the furrow on an easy turn, and placing it downside up, covering trash, weeds, etc., in a perfect manner.

THIRD—All workmanship and all materials used are of the finest. Our aim and ambition are to give the world at large the very finest plow in every particular it has ever had.

FOURTH—All parts of the plows are perfect duplicates, so that an absolute fit is guaranteed on all extras, such as shares, mouldboards, landsides, etc.

The Flanged Landside is a great advantage to the purchaser who has difficult land to plow. It gives greater suction with a natural tendency to steady the plow while running. The Landside is chilled on polished side and bottom, giving greater wearing surface, which adds greatly to the life of the landside.

Price, Plain.....\$16.00 Wheel Extra.....\$2.25 Jointer Extra.....\$4.00

SYRACUSE DRAG SCRAPER

THE CONTRACTOR'S FAVORITE

Prices:

No.	Capacity.	Weight.	Price.	
1	7 cu. ft.	105 lbs.	\$12.00	Solid Pressed Steel With Two Runners
2	5 cu. ft.	95 lbs.	11.00	
3	3½ cu. ft.	85 lbs.	10.50	

Measurements:

No.	Length.	Width.	Depth.
1	33 in.	32 in.	11½ in.
2	31 in.	28 in.	10½ in.
3	30 in.	27½ in.	9 in.

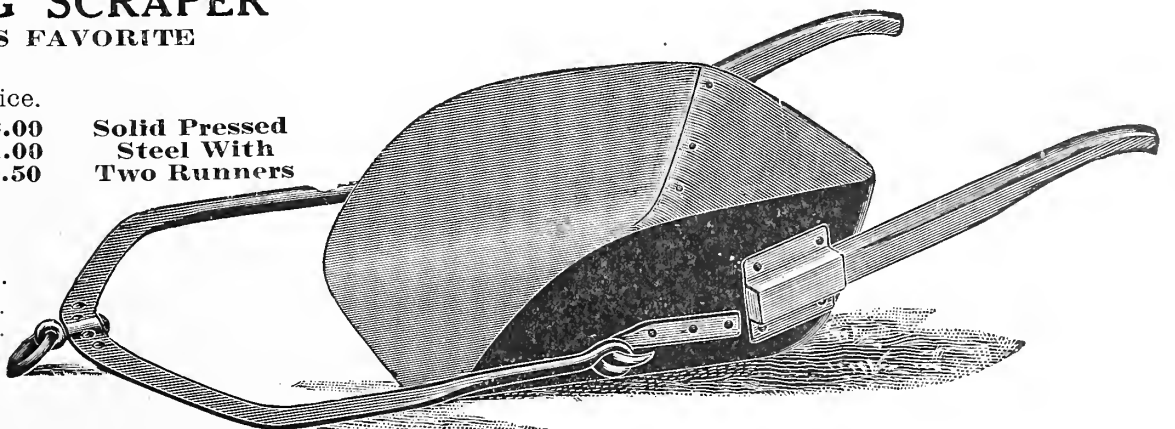

All Prices Subject to Change Without Notice

CHATTANOOGA CHILLED PLOWS

POINTS OF MERIT

FIRST—Low front, similar to Steel Pattern Plows; will not collect trash.
SECOND—Handle not bolted to mould, but to standard and brace that is attached to beam, thus preventing breakage of many moulds.

THIRD—Brace or rod between landside and mould, giving additional strength where it is most needed, making plow absolutely rigid

FOURTH—Special bolts, which will not turn and can be readily taken out. All the

base bolts are alike and interchangeable; only one kind necessary to keep on hand.
FIFTH—Points are fastened on with two bolts; never fails; gives satisfaction.

CHATTANOOGA ONE-HORSE PLOW

The One-Horse Plows as priced below are a little different from design shown in cut. The No. 72 is the factory's latest pattern.

PRICES:

No. 62—Wood Beam.....\$9.50
 No. 62—Steel Beam..... 9.50
 No. 72—Steel Beam..... 8.75

Steel Beam.

Low Front.

(Cut represents Two and Three-Horse Plow.)

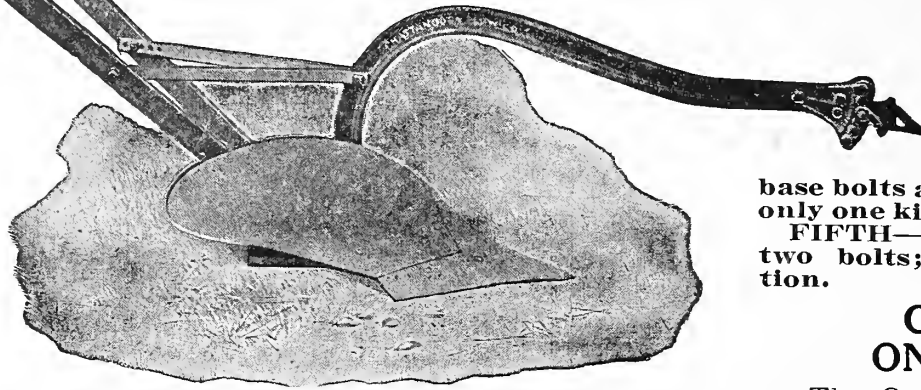

Capacity and Weight Chattanooga Plows:

Nos.	Capac.	Wgt., Lbs.	Price.	Nos.	Capacity.	Wgt., Lbs.	Price.
45—Wood	10x12	124	\$16.00	72	5x 8	75	\$ 8.75
45—Steel	10x12	131	16.00	63	8x10	105	12.75
46—Wood	12x14	144	18.00	64	8x11	123	14.50
46—Steel	12x14	165	18.00	65	10x12	134	16.00
62—Wood	5x 9	60	9.50	66	12x14	165	17.50
62—Steel	5x 9	70	9.50				

GENUINE OLIVER PLOWS

and Genuine Oliver Repairs

	Prices Steel Beam	Prices Wood Beam
A-1 and A-2	\$ 8.75	\$ 8.75
B-N	10.00	10.00
13-N	14.25	14.25
40-XX	20.50
10-N	12.75	12.75
19-N	15.75	15.75
20-N	17.50	17.50
E-1-N	20.00
40-N and 40-X-N	20.00	20.00

Note—A Clevis Wrench and an extra Share are included in prices for Plows fitted with Cast Shares, but Wheels and Jointers are not.

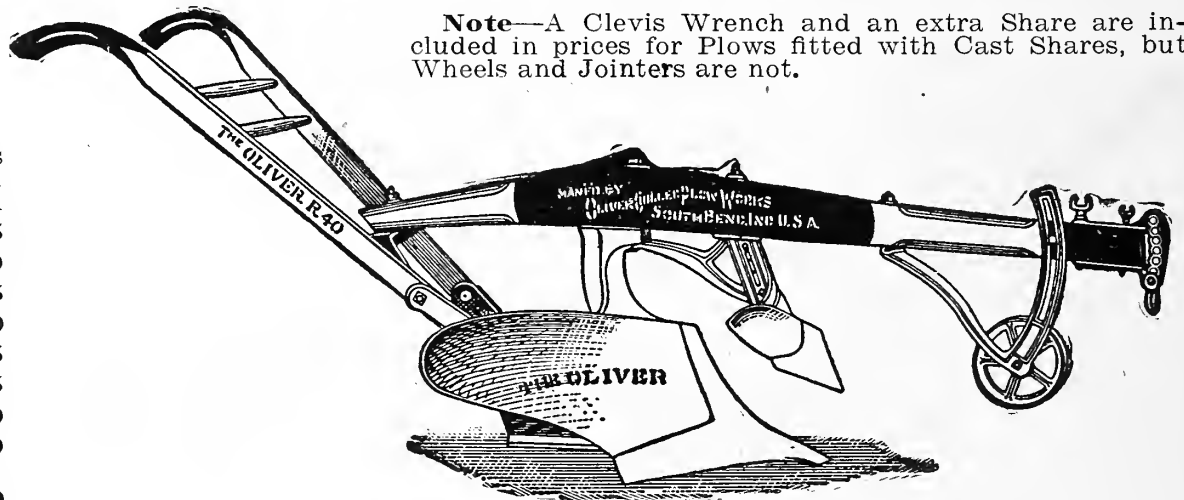

THE ORIGINAL BOSS PLOWS

Prices of Boss Plows and Repairs:

1-Rig.....	\$ 8.50
2-Rig.....	9.50
3-Rig.....	10.50
4-Rig.....	11.50

Repairs:

1½ and 2½ Shares.....	\$0.45
2½ and 3½ Shares.....	.50
20 Shares.....	.70
Landsides, No. 3.....	.60
Beams.....	1.25
Handles, per set.....	1.75
Handles, loose, etch..	.70
1½ and 2½ Moulds....	.60
2½ and 3½ Moulds....	.80
20 Moulds....	1.25

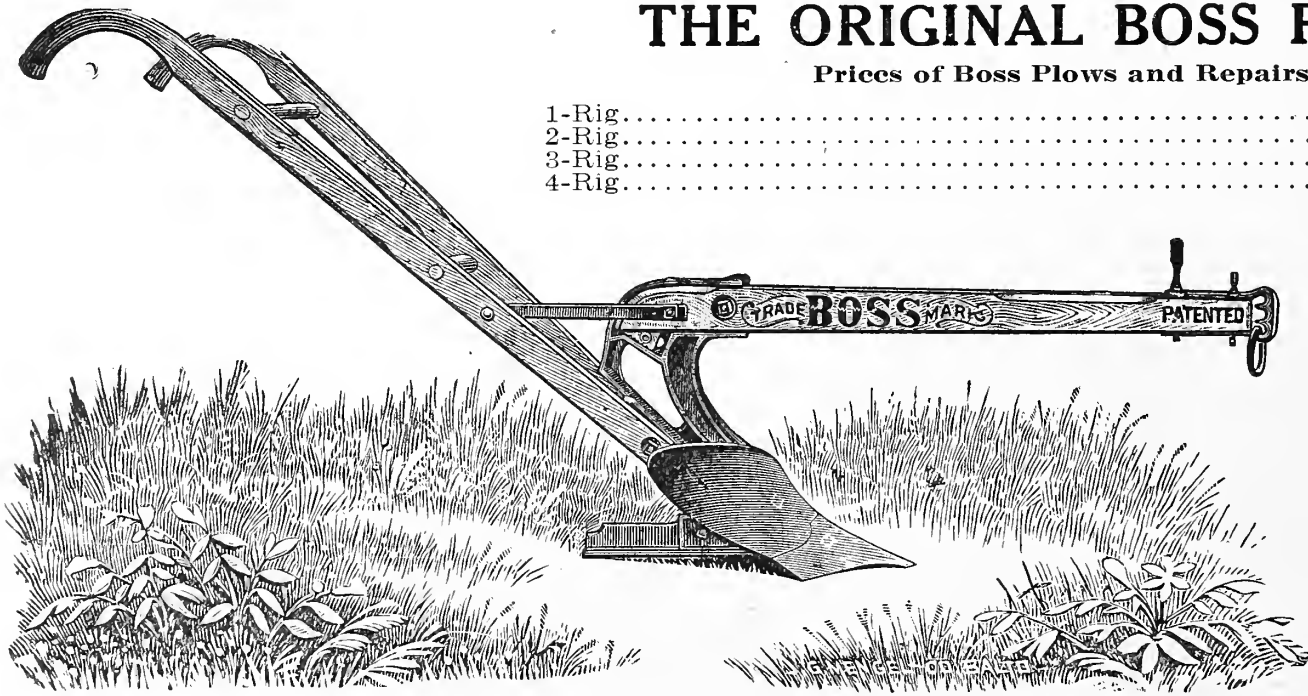

After Plowing the Ground be Sure to Plant The "Wisdom" Tomato, (See Page 23)

THE CHATTANOOGA-HANCOCK SINGLE DISC PLOW

It handles more cubic inches of soil with less draft than any other plow made; it turns under stalks, trash and weeds completely; it breaks up "hard pan" and pulverizes the soil.

It leaves the ground at bottom of furrow porous and natural; it prepares the soil to withstand either a wet or dry season; it insures better crops than any other method of plowing.

It is so simple in design, so few in parts and so perfect in construction that any one can operate it.

It is not a sod plow; it is a pulverizer. You cannot pulverize sod. Everywhere else it is all right.

PRICES:

Single Disc, with Double and Triple Trees.....\$ 85.00
 Double Disc, Double and Triple Trees..... 125.00

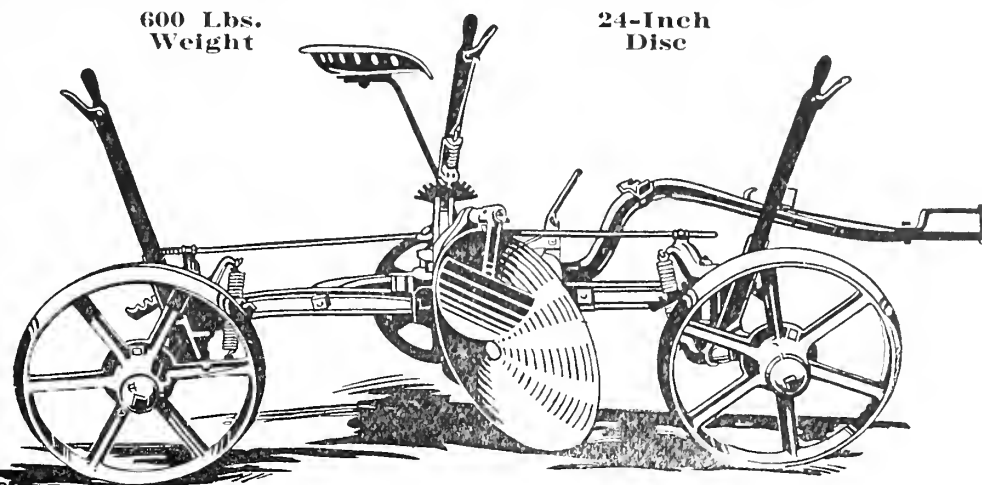

P. & O. SULKY AND GANG LIGHT DRAFT PLOWS

DIAMOND SULKY AND GANG PLOWS

Favorites for more than a quarter of a century. Double-bail. Powerful foot lift. Light draft. High lift. Any of the P. & O. types of bottoms can be furnished. Quick detachable shares. Automatic control—rear wheel follows readily when moving straight ahead, but is automatically released and allowed to caster in making a turn. Levers on right hand side of plow. Easy to reach and giving easy access to the seat from the left hand side. Cushion spring on land axle absorbs shock. 15-inch rolling coulter. Combined coulter and jointer on special order. Sulky plow in 10, 12, 14 and 16-inch. Gang plow in 20, 24 and 28-inch. An 18-inch rolling coulter can be furnished for stony soil.

Prices on application.

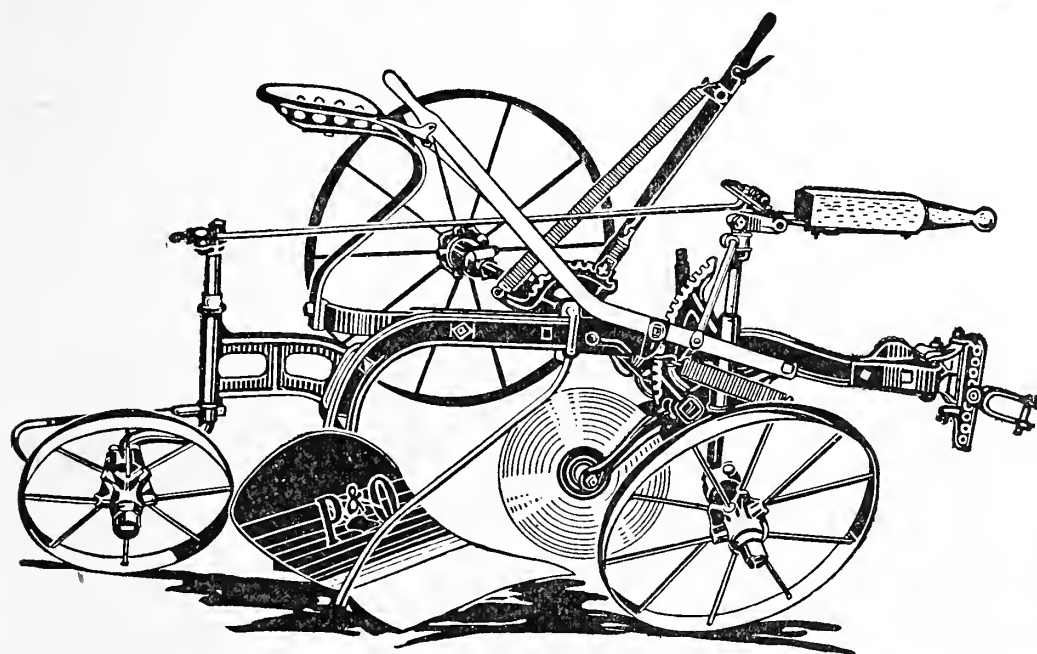

P. & O. No. 5 LITTLE GENIUS TRACTOR PLOWS

The speed with which the bottoms raise and the angle at which they come out of the ground are such that they leave almost perfectly straight headlands. Note in this connection that, in order to leave straight headlands, a three-bottom plow must travel, in entering or leaving the ground, a distance which is practically three times the distance between the bottoms, measured on a line parallel to the landside.

The lifting device operates on all three wheels, raising the whole plow high from the ground, giving ample clearance for trash. We wish to call particular attention to the lift on the rear wheel. It is absolutely positive. The power is transmitted from the land axle through a flexible link connection to a powerful compound toggle operating in connection with the rear axle. There are no sliding parts to bind or hinder its operation—it responds instantly to the action of the lifting device. When the bottoms are lowered the tension on the rear wheel lift is released, relieving it from the strain while the plow is at work.

One lever operates the front furrow wheel and the other lever the land wheel, both levers being used for regulating the depth and leveling the plow. When the plows are in the ground the levers set ahead and are within easy reach of the tractor, but when the bottoms are raised, the levers swing back and do not interfere with the engine when a turn is being made. The levers and bottoms are counterbalanced by springs, making them very easy to operate.

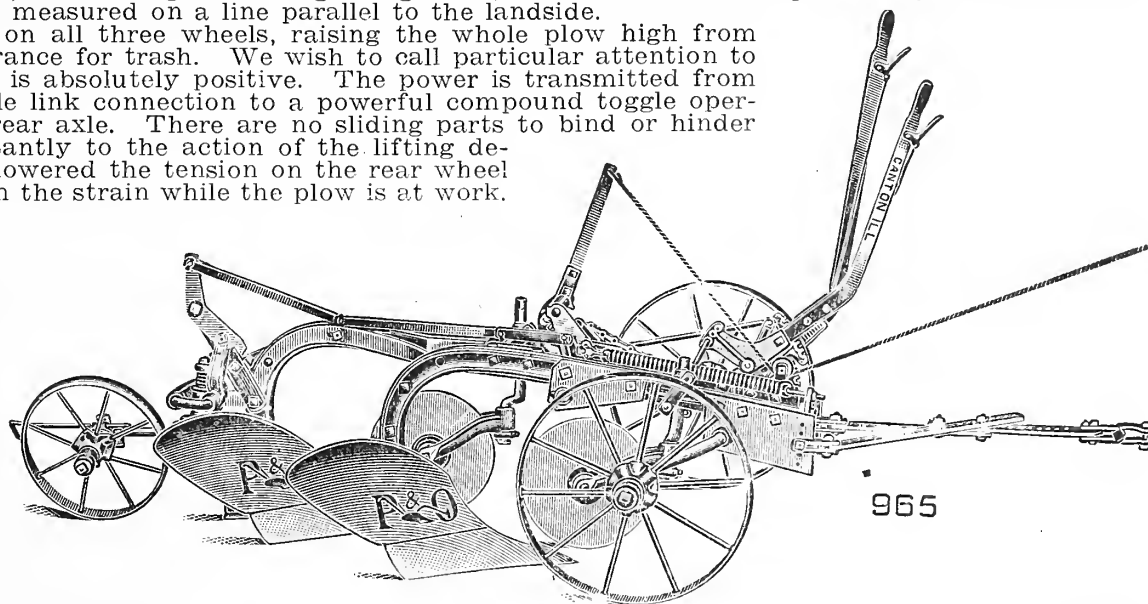

Price, with 12-inch Bottoms.....\$145.00

P. & O. SULKY AND GANG PLOWS

We also carry a full line of P. & O. Sulky and Gang Plows. These plows have all the desirable and well-known features of the Tractor Plow shown above. Can be furnished with any style bottom suitable for all conditions. Send for special catalogue and prices.

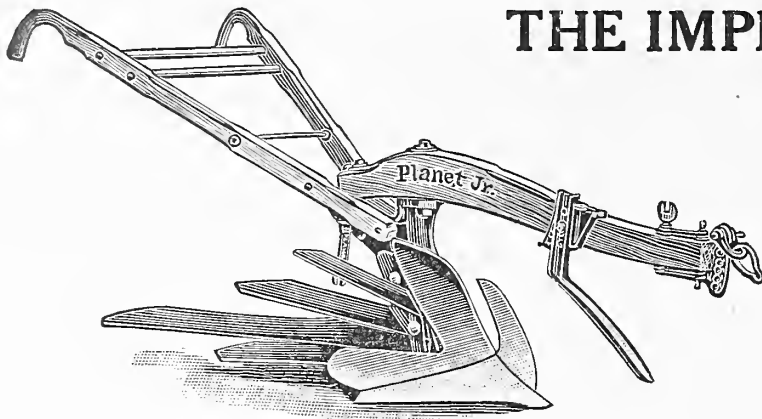

THE IMPROVED "PLANET JR." WHITE POTATO DIGGER

The "Planet Jr." White Potato Digger has been greatly improved recently. Instead of a digging head of tines it now consists of successive shares, which cut the furrow turned on edge by the front share and moldboard into horizontal slices, throwing the vines and weeds to one side and pushing the potatoes to the surface.

Doubtless you would like us to say how they compare with the various four-horse diggers on the market. To answer this, the "Planet Jr." White Potato Digger is equal to any for digging early, when the vines are green, the potatoes fast to them and the ground clean. A little later on, when the vines are dead and the ground fairly free from weeds, the four-horse diggers do better work in some cases, the crop being picked up more easily after them. At a later stage, when the

field grows very grassy and weedy, the four-horse tools are almost useless, while the "Planet Jr." even then does its work fairly well. If compelled to use but one digger the season through, the "Planet Jr." is the best. It costs but one-fourth or one-fifth as much, takes less than half the power to draw it; **DOES NOT SKIN THE POTATOES**, digs faster and costs about one-twentieth as much for repairs, and it will last almost a lifetime, with a few new shares and landsides. Packed weight, 143 pounds. Price.....\$42.50

No. 300 "HOOVER" POTATO DIGGER WITH AGITATING REAR RACK AND VINE SEPARATOR

To meet the various conditions under which potatoes are grown, it was necessary to build several styles and sizes of machines. In making the changes and improvements necessary to the universal use of the "Hoover" they were designed so that two general or main frames would be the basis to which could be added the different attachments that are necessary for the successful harvesting of the crop. The frames are 6 and 7 feet long and of two widths, 20 and 22-inch. The following general description of the construction of the "Hoover" should convince you that nothing but the best of material and workmanship is used in their construction, which in connection with the inventive genius, which is constantly used for their betterment, puts them in a class by themselves, and about five years ahead of all imitations.

SPECIFICATIONS:

Truck—Double-acting, with 14-inch steel wheels provided with removable hubs and bearings.

Frame—22 inches wide, 6 feet long (elevator 5 feet long). Sides made of special Tee steel rolled exclusively for the "Hoover." Malleable pieces for attaching shovel and axle are riveted solidly to the Tee steel sides.

Shovel—High carbon crucible steel.

Elevator—Rod type, made of 3/8-inch high carbon spring steel with every alternate link raised and lowered. (7-16-inch steel furnished when so ordered.)

Bearings—2 1/2-inch roller bearings on main elevator shaft with compression grease cups, 2-inch roller bearings on elevator idlers and pitman shaft. All other idlers run on pipe bearings.

Wheels—30-inch diameter, 3-inch tire. Staggered spokes and removable hubs.

Tread—Main wheels, 37 inches; trucks, 31 1/2 inches.

Drive Chains—Heavy Locke tempered steel running on forged and tempered steel sprockets on main elevator shaft.

Rear Rack—Agitating with vine separating rods and forks. Hangers supporting potato or rod rack swing on pipe bearings. Pitmans agitating potato or rod rack are oval steel with wood bearings. Pitman shaft 7/8-inch cold rolled steel with 2-inch roller bearings and dirt-proof pipe covering screwed in bearing castings. Vine forks revolve on high carbon steel crank provided with removable bearings.

Clearance—19 inches under truck; 15 inches under beams.

Weight—985 pounds.

Price—\$135.00. * With Engine, \$350.00.

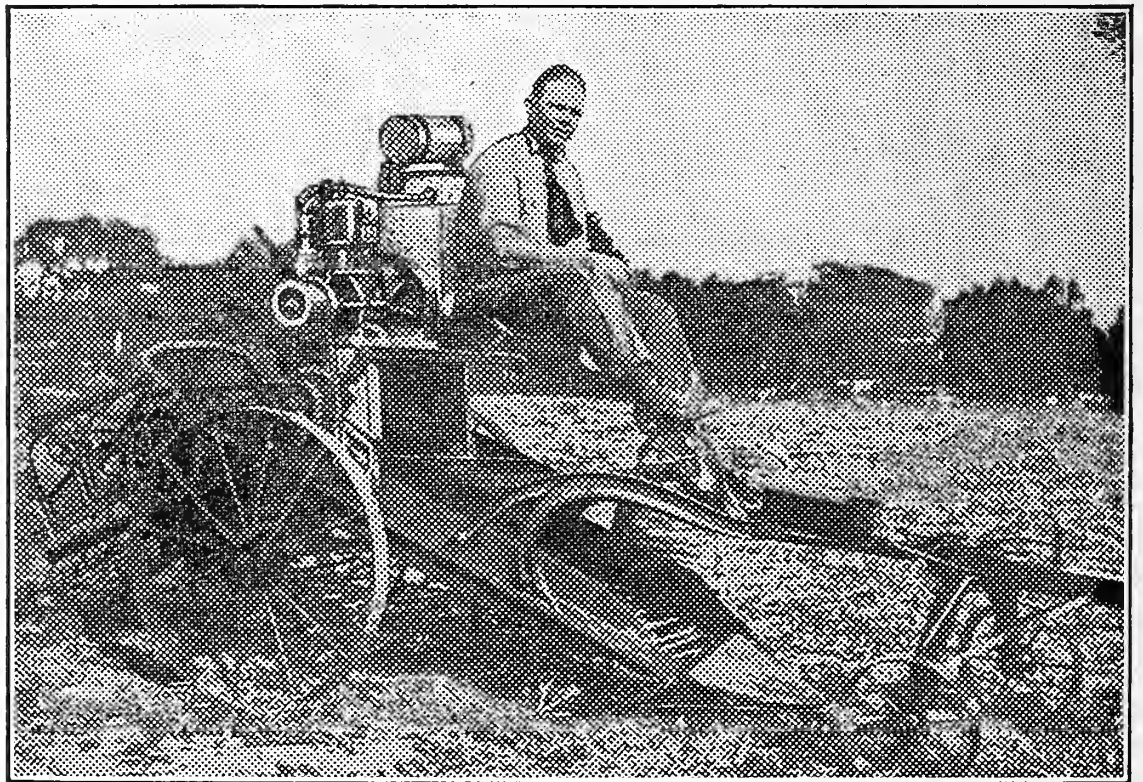

Four-Horsepower Cushman Engine on a Hoover Digger

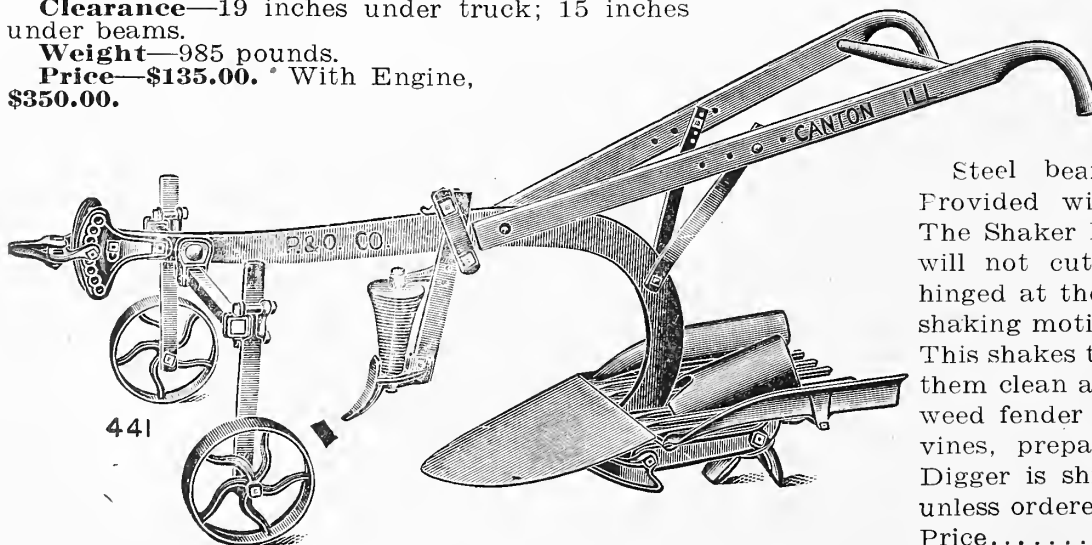

SHAKER POTATO DIGGER

Steel beam. Natural temper steel blades. Provided with weed fender and gauge wheel. The Shaker Digger has a perfectly flat blade and will not cut the potatoes. The rod grating is hinged at the front and is given an up-and-down shaking motion by the sprocket wheel at the rear. This shakes the dirt off from the tubers and leaves them clean and whole on top of the ground. The weed fender is intended to clear away weeds and vines, preparing the way for the blade. The Digger is shipped with gauge wheel and fender, unless ordered without.

Price.....\$27.50

THE IDEAL POWER LAWN MOWER

MADE IN TWO SIZES 22" AND 30".

MECHANISM SO SIMPLE ANY ONE CAN OPERATE IT

Simplicity is its dominating feature. The machine has few parts, and the entire absence of intricate mechanism makes it as near fool-proof as is possible in a machine of this kind. No experienced operator is required—any one who can keep a gasoline motor supplied with gasoline and oil can operate an Ideal Power Mower. Owing to its simplicity and few parts, it seldom gets out of order.



CUTTER IS PULLED INSTEAD OF DRIVEN DIRECT

Experience has shown that the type of mower where the cutting reel is driven direct from the engine by means of sprockets and chain and the mower built rigidly into the frame of the tractor is not practical for the reason that obstacles on the lawn are picked up by the reel, which, being positively driven causes constant breakage.

The principle of the Ideal Lawn Mower is the same as that of the ordinary hand mower. The cutting reel is driven by the traction of the mower wheel. The mower is loosely suspended from the frame of the tractor, and becomes the front axle of the machine. It is pivoted so that it always has a free tilting motion, and the wheels adapt themselves to any irregularity of the ground's surface. The mower, therefore, slides over the lawn and any obstruction which may be encountered merely prevents the blades from rotating, and the wheels slip over the ground with no possible chance for breakage. This means added life to the entire outfit.

The driving roller is made up of three separate castings. The center roller is keyed to the shaft. The two outer rollers run loose on the shaft and are driven by the center roller, which allows them to have a complete turn before engaging with the center drive roller. This feature facilitates turning, as in turning the outside roller is always free to run ahead of the driver.

SPECIFICATIONS

Width cut, 30 inches. Speed per hour, 2 3/4 miles. Diameter roller, 14 inches. Diameter cutting reel, 6 inches. Face mower wheels, 1 3/4 inches. Actual weight, 550 pounds; shipping weight, 735 pounds. Width roller, 24 inches. Will cut, allowing 2-inch lap, 3/4 acres per hour. Diameter mower wheels, 11 inches. Number of cutting blades, 5.

COLDWELL'S IMPROVED HORSE LAWN MOWER

Coldwell's Improved Horse Lawn Mower is conceded to be superior to any other mower on the market. This is the opinion of experts, both mechanics and men who have had long experience in caring for lawns. Some of its points of merit are: Light draft, large driving rollers, non-clogging castor wheels; can be thrown out of gear without driver leaving seat; both sides of machine can be adjusted at once; device for instantly raising all knives from the ground when passing over stones or other obstructions, or when drawing over a roadway; side-draft attachment to prevent horse from walking on grass before it is cut.

Coldwell Mowers wear well. The material is the best. Coldwell Mowers were adopted several years ago by the Baltimore City parks and have been used since then in preference to other makes. They are also used by the leading country clubs and on the principle lawns around Baltimore. Guaranteed to be the best.

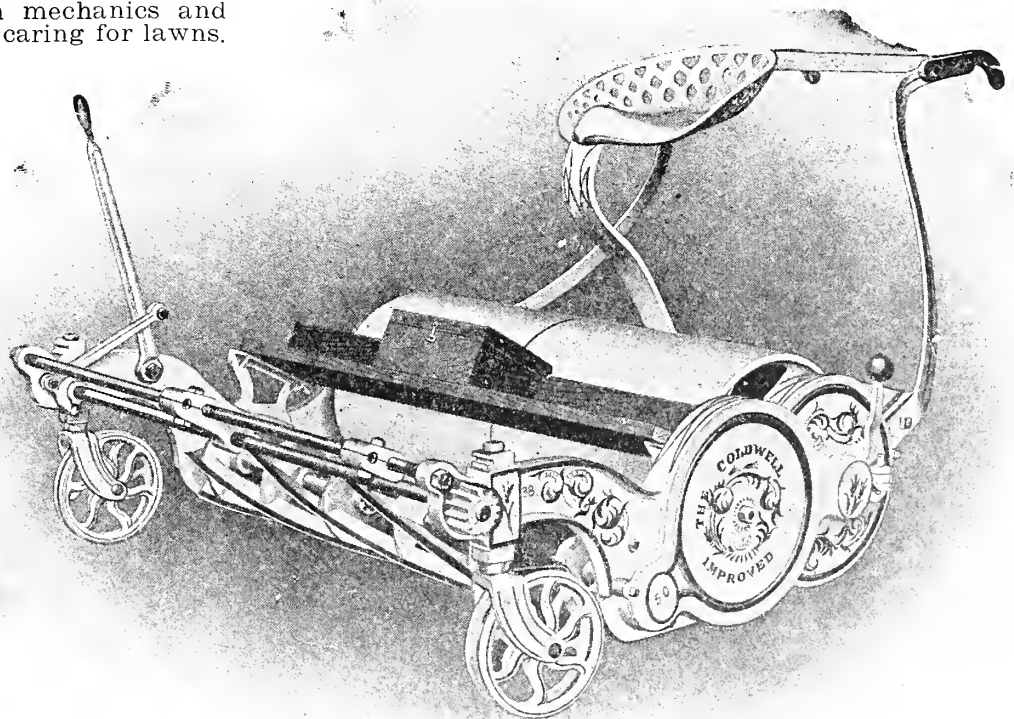

35-inch, complete with seat and shafts.....\$150.00

30-inch, complete with seat and shafts.....\$130.00

THE COLDWELL LAWN MOWERS

COLDWELL IMPERIAL HIGH-WHEEL LAWN MOWER

This machine is without doubt the best non-ball-bearing Lawn Mower manufactured. Ten-inch drive wheel, rigid of frame, steel blades, thorough in material and workmanship in every respect.

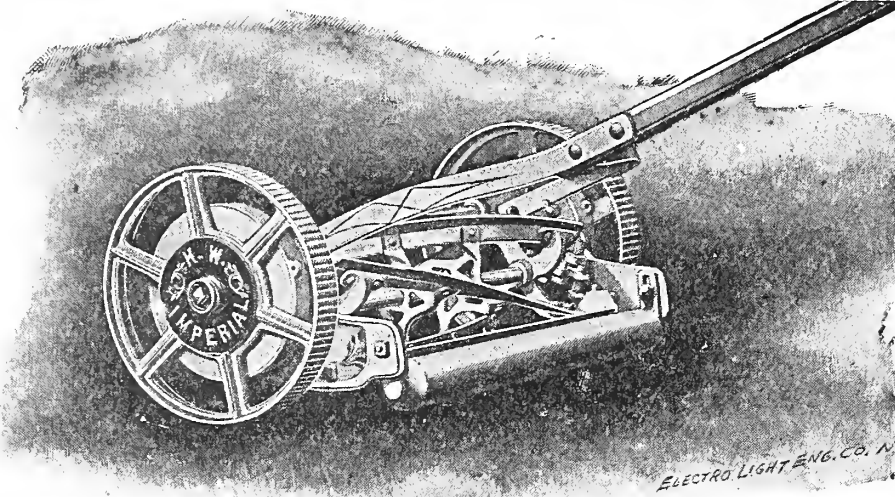

16-inch.....\$18.00 18-inch.....\$20.00
20-inch.....\$22.00

"DIXIE"

This is a good Mower, at a medium price, for all ordinary work. It is made on thoroughly practical lines and is so constructed that it cannot be easily disarranged. The drive wheels are 9 inches in diameter, with the gears raised up from the ground, fully protected from the dirt and cut grass. The revolving cutter is 6 inches in diameter and has 4 crucible steel blades highly tempered and ground true their entire length. It is carried on our patented adjustable ball bearings.

14-inch.....\$11.00 16-inch.....\$12.00
18-inch.....\$13.00

COLDWELL'S RAJAH LAWN MOWER

Coldwell's Rajah is a strictly high-grade ball-bearing Lawn Mower. It is made of first-class material throughout and the workmanship and finish are unsurpassed. It has large

driving wheels and fine-cut gears, thus insuring ease and quietness of running. The large diameter revolving cutter, which is furnished with five blades, makes it an exceptionally high-class Lawn Mower and one that cuts fine and even. It is provided with sliding pawl ratchets in each wheel, and the adjustment of the bearings and knives are the simplest ever made. The adjustment of the bearings is accomplished by means of one screw conveniently located at the end of the revolving cutter, by means of which all the looseness in the bearings can be taken up. A locking screw holds them securely in place. This Mower is furnished with Coldwell's patent double-edge bottom knife, which is shaped like a piece of channel iron, with two upturned highly tempered edges. This makes it far stiffer than the old style flat knife and also permits a new cutting blade to be brought into use should one become injured or worn out.

16-inch.....\$18.00 18-inch.....\$20.00 20-inch.....\$22.00

GREAT SOUTHERN

This is an easy-running ball-bearing Mower of exceptional value for the money. Owing to the design, it is light but strong and durable. The revolving cutter is 6 inches in diameter and has 4 hardened crucible steel blades, full size and weight, which are mounted on strong malleable flanges. The balls and cones are hot forged tool steel, ground true, highly polished and hardened by a new process of tempering. The adjustment of the ball bearings is simple and very easy, and is also positive and accurate. The bottom knife is a solid steel blade oil-tempered and is adjusted to the revolving cutter in a simple but positive manner. The ratchet has a flat steel sliding pawl working with the revolving cutter gear, and is strong and reliable.

14-inch.....\$12.00 16-inch.....\$13.00 18-inch.....\$14.00

Horse and Hand Lawn Mowers Sharpened and Repaired in a Thorough and Satisfactory Manner



Coldwell's "Regal" is the best ball-bearing lawn mower on the market, the principal feature being that the ball-bearings are in the drive wheels instead of in the revolving cutter journals, these latter being supplied with adjustable bronze bushings. By having ball-bearings in the drive wheels, the weight of the lawn mower is carried thereon, and when the bearings are adjusted the drive wheels are brought back to their original centers; this prevents crowding of the gears and never allows the drive wheels to get loose.

These lawn mowers are equipped with five blades, our patent reversible channel-shaped bottom knife, triple-pawl indestructible ratchets in both wheels and the simplest adjustment of knives ever made. The gears are fine cut, insuring quietness of running, while the large diameter drive wheels insure lightness of draft. The handle adjustment is such that it can be readily adapted for mowing terraces; they can also be supplied with grass catchers when desired. It is fully guaranteed to give entire satisfaction and to have double the life of any other lawn mower on the market, as all its bearings are cheaply renewable, being fastened to and not a part of the side frames.

PRICES REGAL MOWERS

16-inch.....\$22.00 18-inch.....\$24.00

INTERSTATE BALL-BEARING MOWER

A first-class ball-bearing machine of sterling merit. Where a light machine is wanted, which is likely to be used by a lady or child, this is the machine to purchase.

16-inch.....\$14.00
18-inch.....15.00

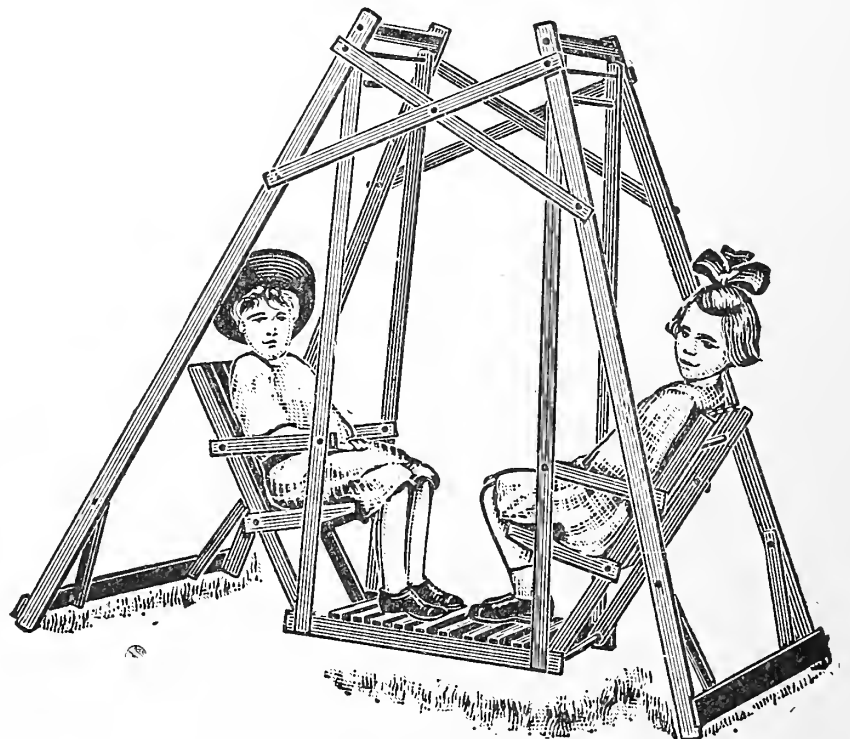

LAWN SWING

Made for durability and wear. A far superior article to the ones bought in department stores. Price of 2-passenger Swing, \$8.00. 4-passenger, \$11.00.

TUBULAR STEEL PLOW DOUBLE TREES

Can furnish these in sets complete, as shown in cut, or can furnish Single Trees separate. They are extensively used, both for farm plowing and by contractors for heavy work. They last a lifetime..

No. 0—Light, 33-in. Double Tree, 28-inch Single Trees; weight, 18 lbs. Per set.....\$4.25
 No. 1—Regular, 36-in. Double Tree, 30-in. Single Trees; weight, 20 lbs. Per set.....\$6.00
 No. 2—Heavy, 36-in. Double Tree, 32-in. Single Trees; weight, 25 lbs. Per set.....\$6.25

Tubular Single Trees
 26-inch.....\$1.25
 28-inch..... 1.50

Tubular Single Trees
 30-inch.....\$1.75
 32-inch..... 2.00

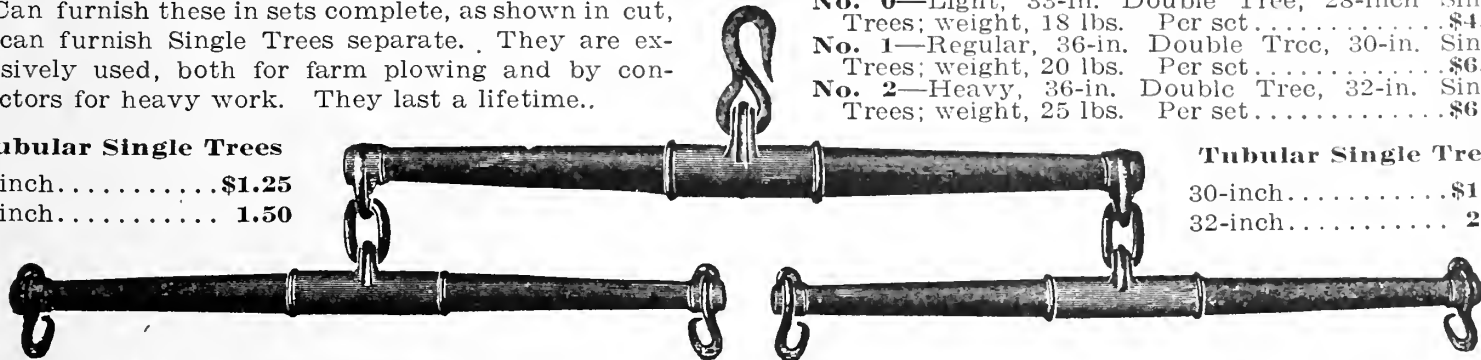

WOOD PLOW DOUBLE AND SINGLE TREES

These Trees are made of selected stock, very strong and durable, and are heavily ironed. The cut shows style of Double Tree; the Single Trees have clips in the center and hooks at the ends.

Per set, 36-inch Double Tree and 30-inch Single Tree.....\$3.00
 Per set, 40-inch Double and 32-inch Single Trees..... 3.50
 Double Tree only, 36-inch, \$1.30; 40-inch..... 1.50
 Single Tree only, 28-inch, 65c; 30-inch, 85c; 32-inch..... .90
 Heavy Lap Links for connecting Double and Single Trees, each. .25
 Heavy Single Tree Clips, per set..... .90
 Heavy Double Tree Clips, per set..... 1.15

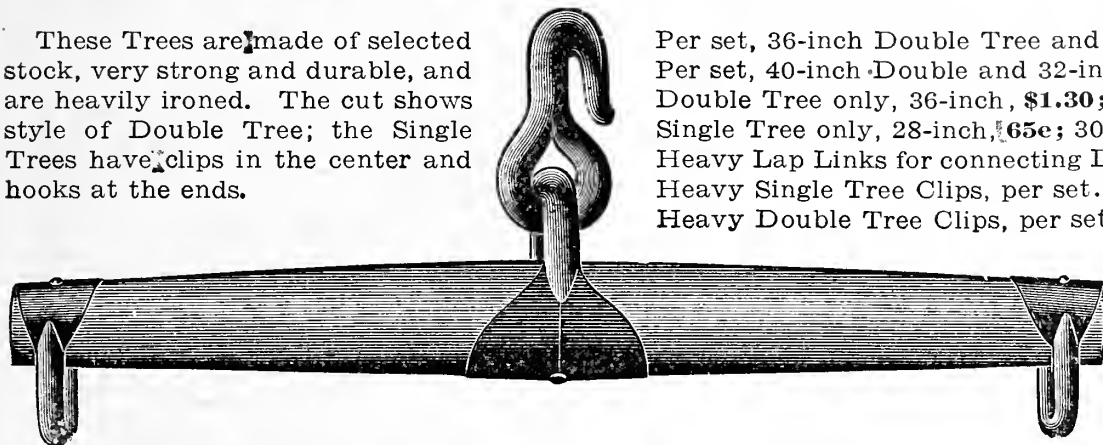

Wood Neck Yokes

Ironed complete, each....\$1.50

Extra-Heavy Plow Triple Trees

Each.....\$3.25

THE HALLOCK QUADRUPLE WEEDER AND CULTIVATOR

This is a tool which has rapidly grown in favor, and excellent results are obtained from its use. The frame is of angle iron. The teeth are 6 inches apart on each frame and each tooth is bolted on separately. The handles and shafts are adjustable. The teeth are arranged so as to work the ground thoroughly, and also in a manner that permits trash to pass through. By removing 1 tooth, a space of 4 inches can be obtained over the row, and by removing 2 teeth a space of 6 inches can be obtained. On account of this feature the Weeder can be used for working narrow rows by taking out the proper number of teeth. This tool has been adopted and passed upon favorably by many of the most practical farmers.

Price.....\$15.00

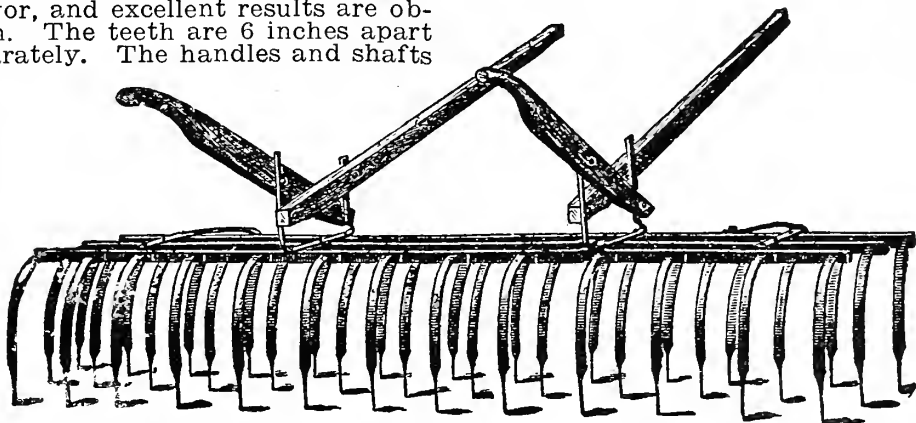

“OUR BEST” SINGLE SHOVEL PLOW

The design of this Plow is readily understood from the cut. It has a heavy steel beam of good quality and a broad steel shovel. One of the most valuable tools around the farm.

Price.....\$4.25

“OUR BEST” DOUBLE SHOVEL PLOW

Every farmer realizes the value of a Double Shovel Plow, with a good set. The Plow we illustrate is strong and runs nicely. It will give good service.

Price.....\$4.50

TRIPLE SHOVEL PLOW

The Triple Shovel Plow, or, as it is often called, Three Shovel Drag, is one of the best known and most efficient tools for working corn. In some sections they are used almost exclusively. The beams of our Triple Shovel Plow are of a good grade of steel, and heavy enough to stand severe work. The shovels are of good quality, and on the whole, the tool will give great satisfaction and long service.

Price...\$5.25

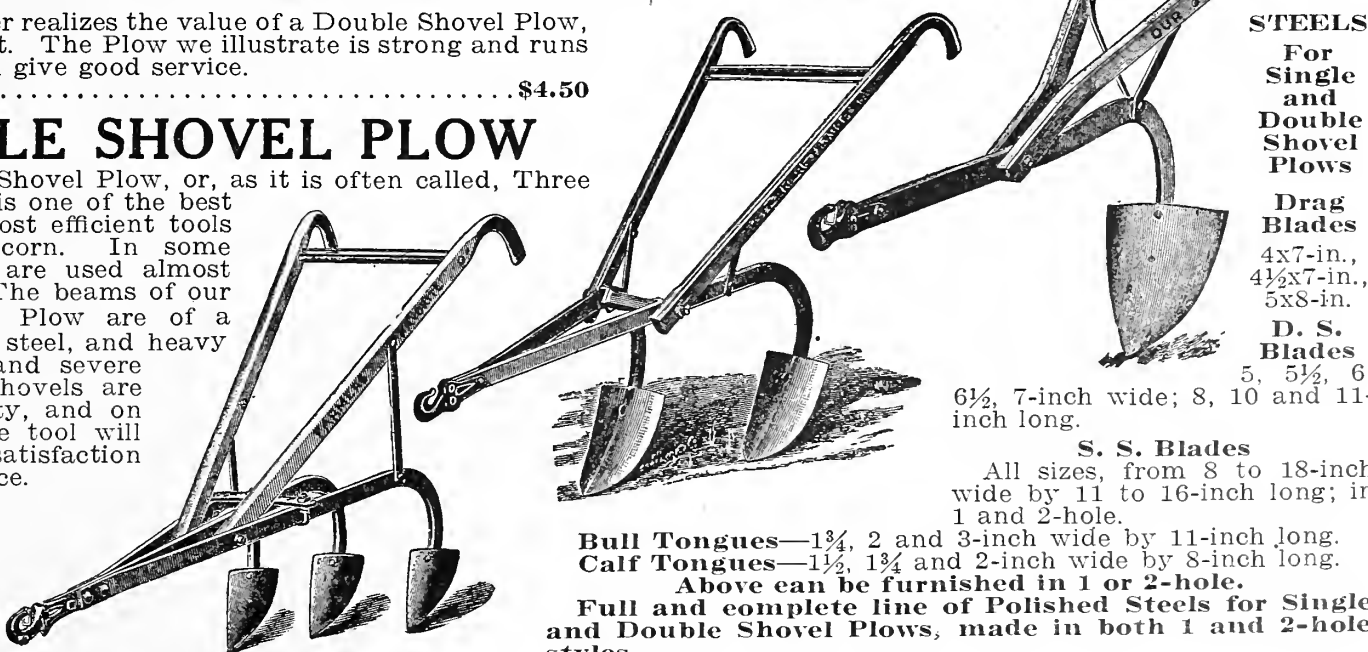

STEELS
 For
 Single
 and
 Double
 Shovel
 Plows

**Drag
 Blades**
 4x7-in.,
 4½x7-in.,
 5x8-in.

**D. S.
 Blades**
 5, 5½, 6,

6½, 7-inch wide; 8, 10 and 11-inch long.

S. S. Blades

All sizes, from 8 to 18-inch wide by 11 to 16-inch long; in 1 and 2-hole.

Bull Tongues—1¾, 2 and 3-inch wide by 11-inch long.
Calf Tongues—1½, 1¾ and 2-inch wide by 8-inch long.

Above can be furnished in 1 or 2-hole.

Full and complete line of Polished Steels for Single and Double Shovel Plows, made in both 1 and 2-hole styles.

WATER TRUCKS and COMBINATIONS

WITH STEEL WHEELS

Fig. 1 represents our Barrel Cart, to which can be attached any of our Barrel Spray Pumps. This is a convenient combination, and may be found useful in various ways, such as watering gardens, spraying fruit trees, etc. Fig. 2 shows Truck with Leaf Rack Attachment. Fig. 3 shows Truck and Box, with Barrel detached.

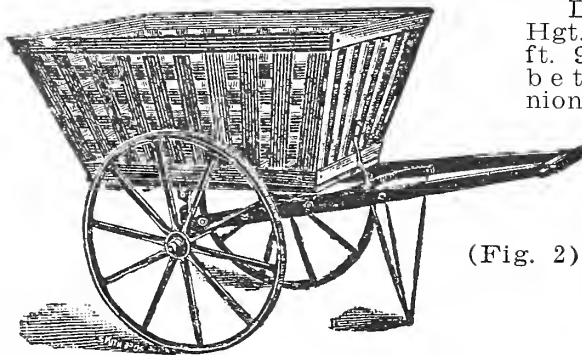

Dimensions:
Hgt. of Wheels, 2 ft. 9 in.; distance between Trunnions, 2 ft. 2½ in.; width Tire, Steel, 1½ in., 2½ in., 3½ in.; Wood, 1½ in., 2½ in., 4 in.
Box Inside Measure:
Width, 22½ in.; Length, 24 in.; Height, 8½ in.
Box has Tall Door. Prices.

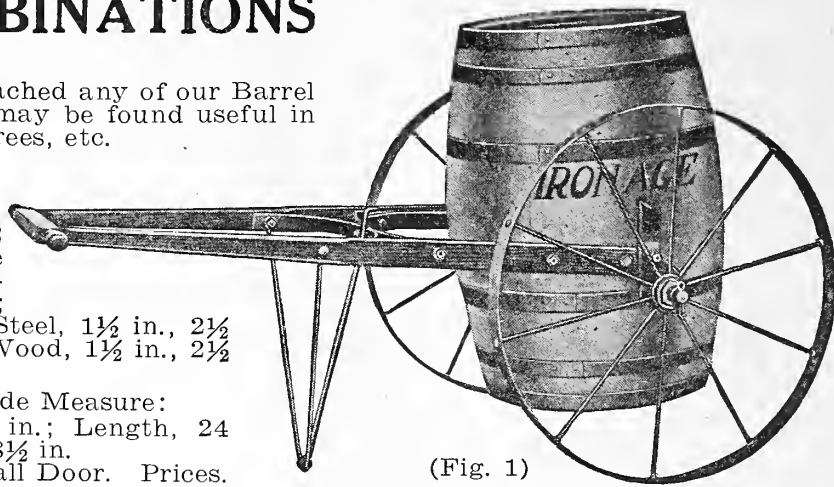

Water Truck, with Regular 1½-inch Tire, Steel Wheels.....\$13.75
Water Truck and Barrel..... 19.75

Water Truck and Barrel.....\$19.25
Water Truck, Barrel and Box.....27.00 (Fig. 3)
Sprinkling Attachment.....6.00
Leaf Rack.....10.50
Barrel.....6.00
Box.....5.50
Trunnions, per pair.....1.00
Trucks with 2½-in. Tire Steel Wheels, add to Regular Tire Truck.....1.10
Trucks with 3½-in. Tire Steel Wheels, add to Regular Tire Truck.....2.80
Trucks with Regular 1½-in. Tire Wood Wheels.....13.75
Trucks with 2½-in. Tire Wood Wheels, add to Regular Tire Truck.....1.10
Trucks with 3½-in. Tire Wood Wheels, add to Regular Tire Truck.....2.00

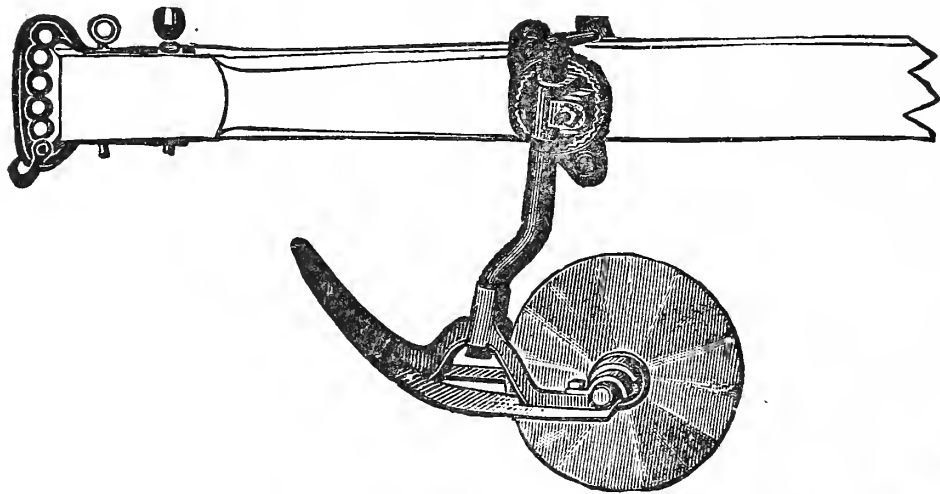
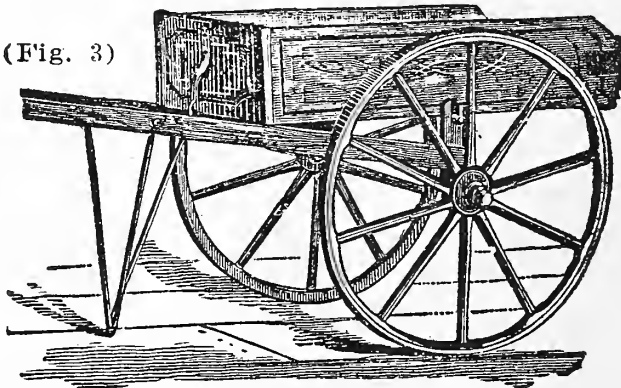

COULTER "MOON" ROLLING

The shoe presses down all weeds and trash and holds same firmly while being cut by the Coultershoe.

Prices:

No. 1— 8-inch disk.....\$5.50
No. 2—10-inch disk..... 6.00
No. 3—12-inch disk..... 6.50

BENT TRAY WHEELBARROW

This is a "full bolted" Barrow and is set up for shipment.

Full-sized Bent Tray, well planed, cleated, braced and bolted. Legs and cross pieces gained, leg braces extending beyond handles, bracing tray, and bolted to it.

Diameter of Wheel, 17 inches; Tire 3-16x1½ inches; Spokes, 7/8x1 inch; ½-inch Axle Bolt.

Price.....\$3.75

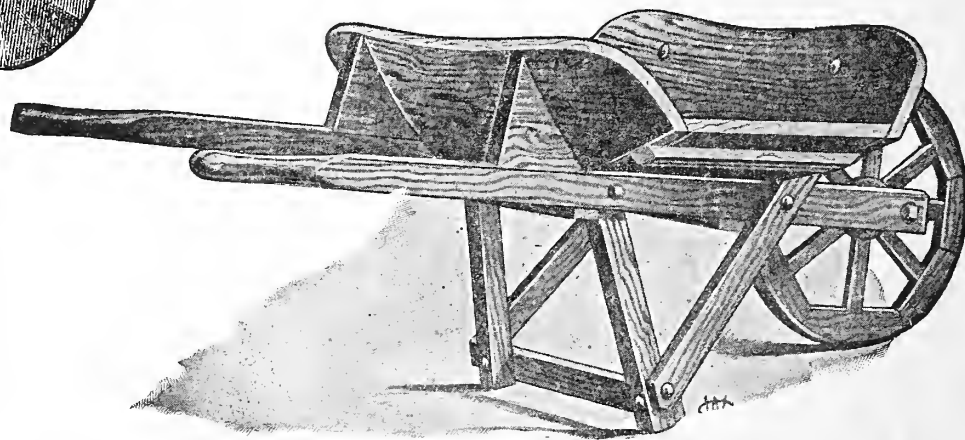

BUCH'S Nos. 2 AND 3 WHEELBARROW

A durable, neat Garden Barrow. Size of body, 28 inches long, 20 inches wide in front, 24 inches wide at back; Sideboards, 27 inches long, 12 inches high; Handles, 5 feet long, 2x1¼ inches; Wheel, 20 inches diameter, 6 Spokes.

Prices:

No. 2.....\$7.50
No. 3..... 7.00

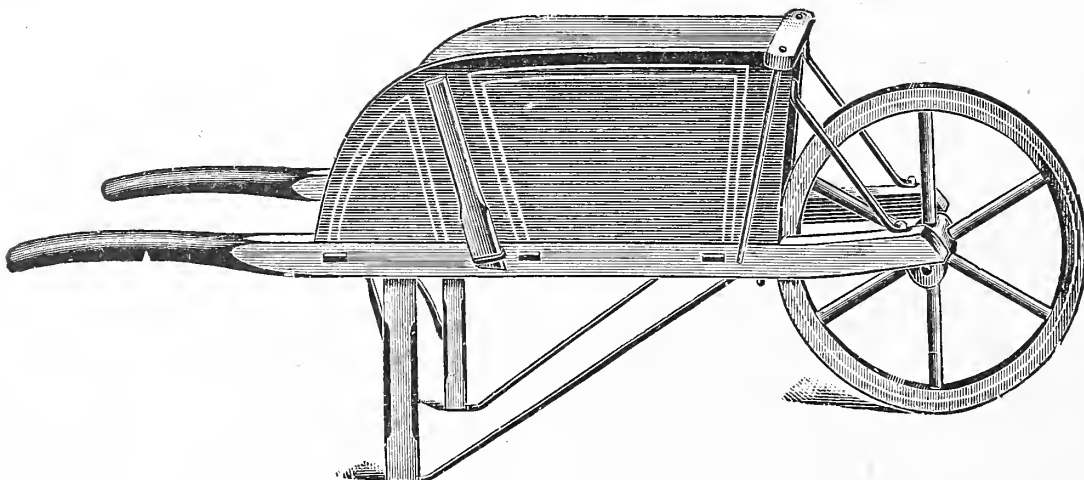

No. 170 Single-Row Fertilizer Distributor.

"IRON AGE" AND SPANGLER SINGLE-ROW FERTILIZER DISTRIBUTORS



This is a most convenient and satisfactory machine to distribute fertilizer in an open furrow after the ground is prepared for planting potatoes, tobacco, corn, peas, beans, etc. This machine has practically the same force feed as used on the well-known "Iron Age" Potato Planter where it has been successfully used for a great many years. The mechanism of this fertilizer distributor is exceedingly simple, yet positive, in its action. The revolving disc and feed wheels are so arranged that they keep the fertilizer in a loose, evenly and easily handle condition. The galvanized hopper holds a full peck, 167 pounds. A gate regulates the amount of fertilizer sown, and saves waste when turning at end of rows. This machine has two feed wheels and 3 different sprocket wheels to regulate the amount of fertilizer sown. Will sow fine or coarse fertilizer 400 to 3,000 pounds to the acre.

Stirring point in the rear mixes fertilizer with the soil.
Price.....\$28.00

FARMER'S FRIEND PEA AND BEAN DRILL

This simple, compact and splendid working tool has for many years held its own against all competitors. Each year it gains a host of new friends and becomes more popular. The runner and covering wheel are distinguishing features of this machine. These make it practically 1/2 of a 2-horse planter, the runner cutting a furrow, the wheel closing it and packing the earth over 8, 12, 16 and 20 inches apart. Plates for ensilage and for any kind of seed can be obtained. Plants corn, peas and beans. With special plates, which we can furnish, it will plant peanuts, rice, broom corn, sorghum, popcorn, carrot, beet, turnip, millet, onion seed, etc.

Price, Plain.....\$22.00
With Fertilizer Attachment... 24.00

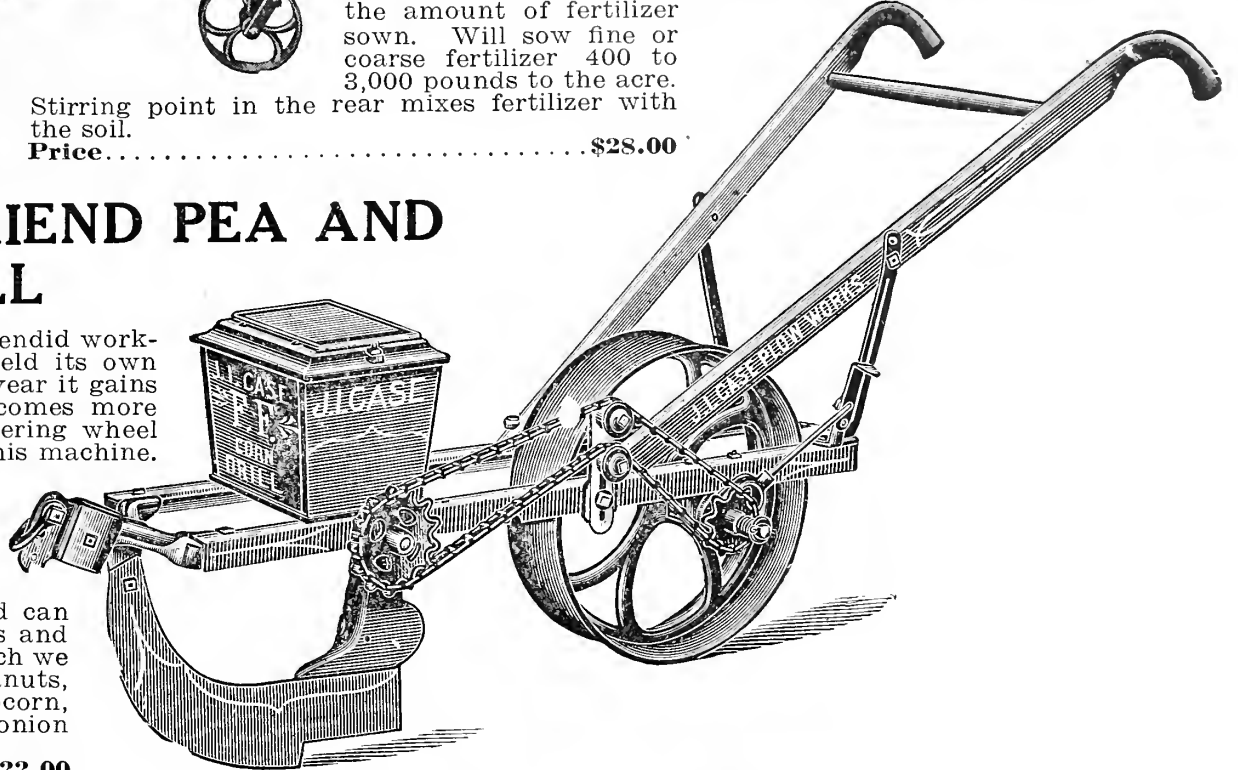

BINDER TWINE



It is impossible to give the price of Binder Twine in advance, as the price is subject to market changes. Write for prices.

INTERNATIONAL KNIFE GRINDER

There is nothing harder on the mower or on the team than dull knives. The International Knife Grinder can be clamped to the rim of the wheel, where it is easy to use. The knife sections can all be ground with a perfectly clean beveled edge, all of them exactly alike. This grinder is equipped with a fine-tempered steel regulator, which adjusts the pressure so that all of the sections can be ground evenly and regularly. The handle runs parallel to the knife, which is always in plain sight while being ground. Thus there is no danger of cutting the operator's hands. The grinder can also be fastened to a bench. A special stone for grinding tools or gumming saws will be furnished on special order.

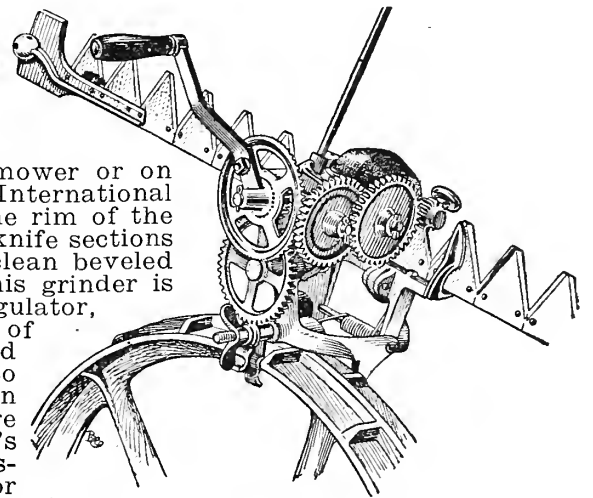

Price.....\$6.00

"NEW MODEL" SEED DRILL

We have exact regulation of seed discharge by using an eccentric index or indicator, which adjusts the slide for seed opening exactly where you want it.

Packed weight, 50 pounds.

Price, \$11.00.

A Seed Drill with 30 years' success behind it.

Exact adjustment for flow of seed. Marked adjusted either side. Covering wheel attached so you can roll soil high and heavy.

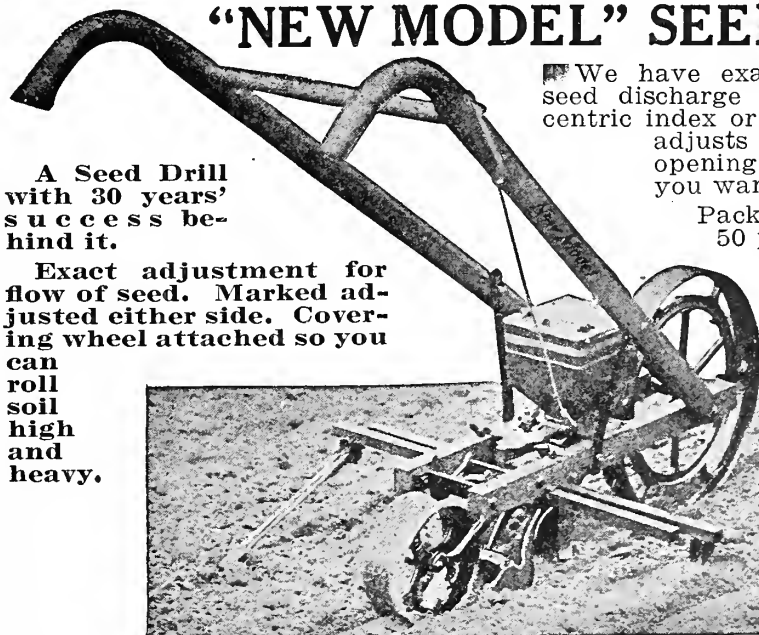

CRYSTAL METAL FARM BELLS



These Bells are covered with a rich gold bronze, black varnished hangings. No. 1, 40 lbs., \$4.50; No. 2, 50 lbs., \$6.00; No. 3, 75 lbs., \$8.00; No. 4, 100 lbs., \$11.00.

HAND POWER HORSE CLIPPING AND SHEEP SHEARING MACHINES

Progressive, Up-to-Date Farmers and Horse Owners Everywhere Recognize the Advantage of Clipping Horses

Stewart No. 1 Enclosed Type Ball-Bearing Clipping Machine (Latest Model)

Has new style rigid base; tubular upright. All gears are cut from solid metal and are enclosed in a dust-proof metal box. They run constantly in a bath of oil, which reduces friction to a minimum. All wearing parts are hardened tool steel. New type, light, easy running, flexible shaft, 6 feet long. Complete, with one set of Stewart's 1-nut tension knives. Weight, boxed, 36 pounds.

Price.....\$12.00

1902 Chicago Clipping Machine (Stewart Patent)

Has positive power; rigid base; fine strong crank handle; 6½-foot flexible steel shaft. All gears are cut from solid metal and wearing parts all tool steel hardened. Can be turned with either right or left hand. Complete, with one set of Stewart's 1-nut tension knives in case. Weight boxed 56 pounds. Price each.....\$17.50

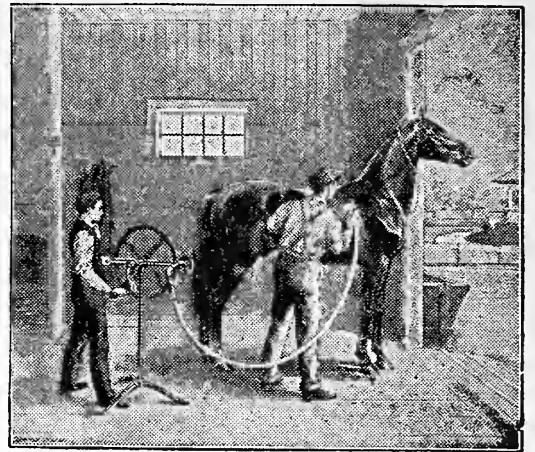

PARTS OF HANDLE AND KNIFE USED ON ALL

No.		Net Weight.	List Price.
C-1	Stewart Horse Clipper Handle and Knife, complete.....	20 oz.	\$3.50
C-2	Pair Stewart Horse Clipper Blades, top and bottom.....	8 oz.	2.50
C-3	Horse Clipper Handle, complete, without knives.....	10 oz.	1.00
90	Top Plate.....	3 oz.	1.00
91	Tension Spring of Handle.....	1-16 oz.	.05
92	Tension Bolt of Handle.....	1-6 oz.	.05
93	Eccentric Roll of Handle.....	1-15 oz.	.10
94	Tension Nut of Handle.....	1-6 oz.	.05
95	Pin and Shaft of Handle.....	2½ oz.	.35
97	Shank of Handle.....	3½ oz.	.40
98	Front Part of Handle.....	4 oz.	.50
99	Bottom Plate of Handle.....	5 oz.	1.50

SHEEP SHEERING ATTACHMENT

For Use on Our No. 1 or No. 2 Horse Clipping Machines

This attachment consists of complete No. 5 Stewart Shear Head, 4 sets of shearing knives, the solid core, universal jointed shaft and cogs, as shown here. Weight, boxed, 15 pounds. Price of complete attachment, as described, \$11.50.

THE STEWART No. 2 CHICAGO HORSE CLIPPING MACHINE

For Large Stables

A strong and powerful machine for large stables and custom clipping. Extra-rigid construction throughout. Wearing parts all hardened tool steel. Has 6½-foot flexible shaft and Stewart clipping head. The most powerful and durable clipping machine ever made. Shipped knocked down, in strong box. Weight, 70 pounds. Price, complete, \$17.50.

BUCH'S RIVETLESS STEEL TROUGHS

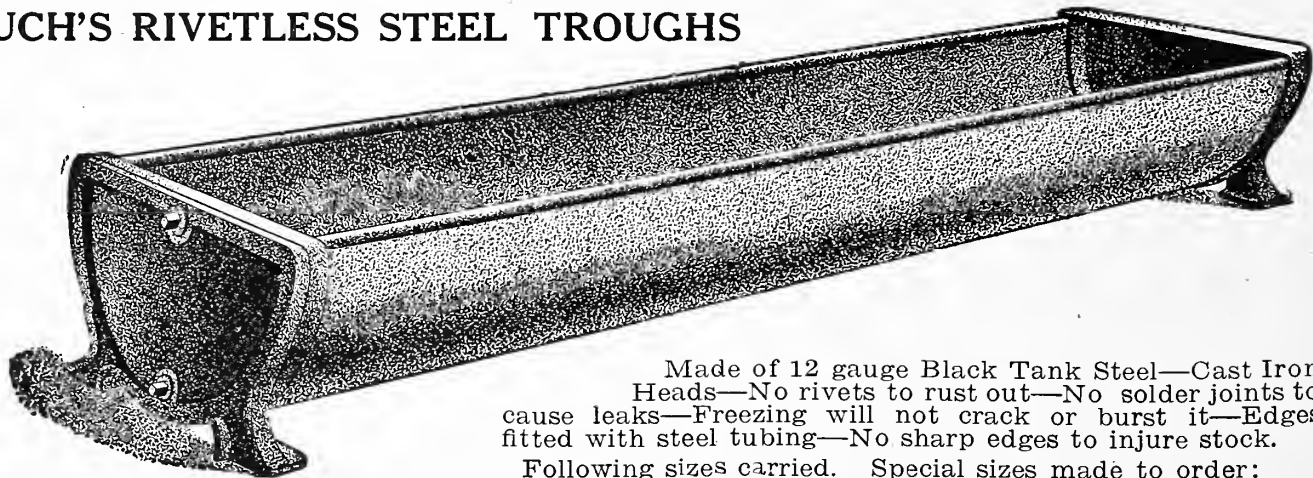

Made of 12 gauge Black Tank Steel—Cast Iron Heads—No rivets to rust out—No solder joints to cause leaks—Freezing will not crack or burst it—Edges fitted with steel tubing—No sharp edges to injure stock.

Following sizes carried. Special sizes made to order:

No.	Length Feet.	Width at Top Inches.	Depth Inch.	Capacity Gals.	Weight Lbs.	Price.
58	5	14	8	20	65	\$ 8.75
59	6	14	8	24	76	10.50
60	8	14	8	32	93	13.00
61	10	14	8	40	119	16.00
69	5	16	9	30	70	10.00
70	6	16	9	36	85	12.50
71	8	16	9	48	111	15.50
72	10	16	9	60	127	18.00
80	5	18	10	40	91	11.50
81	6	18	10	48	102	13.50
82	8	18	10	64	122	17.00
83	10	18	10	80	141	22.00
84	12	18	10	96	168	25.50

EXTRA—Float Valve, Partition and Cover and Overflow..... 15.00
Square Troughs made to order.

No seams for food to lodge in, and, being easy to clean, there is no likelihood of foul, unhealthy odors. There is no danger of bursting from freezing, and the price is within the reach of all. These Troughs are very popular with all who use them. The width of these Hog Troughs at the top is 12 inches and at the bottom 2 inches; the depth is 6 inches, and the capacity per foot is 2 gallons. They are made in lengths as follows: 2, 2½, 3 and 3½ feet, and so on, every half foot, up to 8 feet. Price, per foot, 90c.

CAST IRON HOG TROUGHS

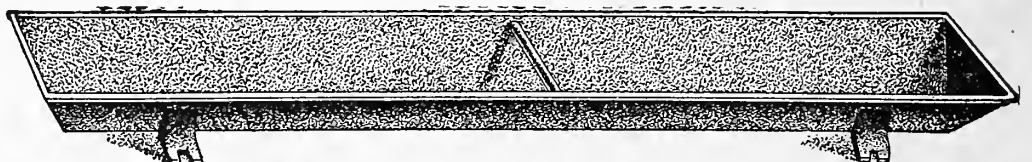

They are made in lengths as follows: 2, 2½, 3 and 3½ feet, and so on, every half foot, up to 8 feet. Price, per foot, 90c.

"HOOVER" POTATO CUTTER

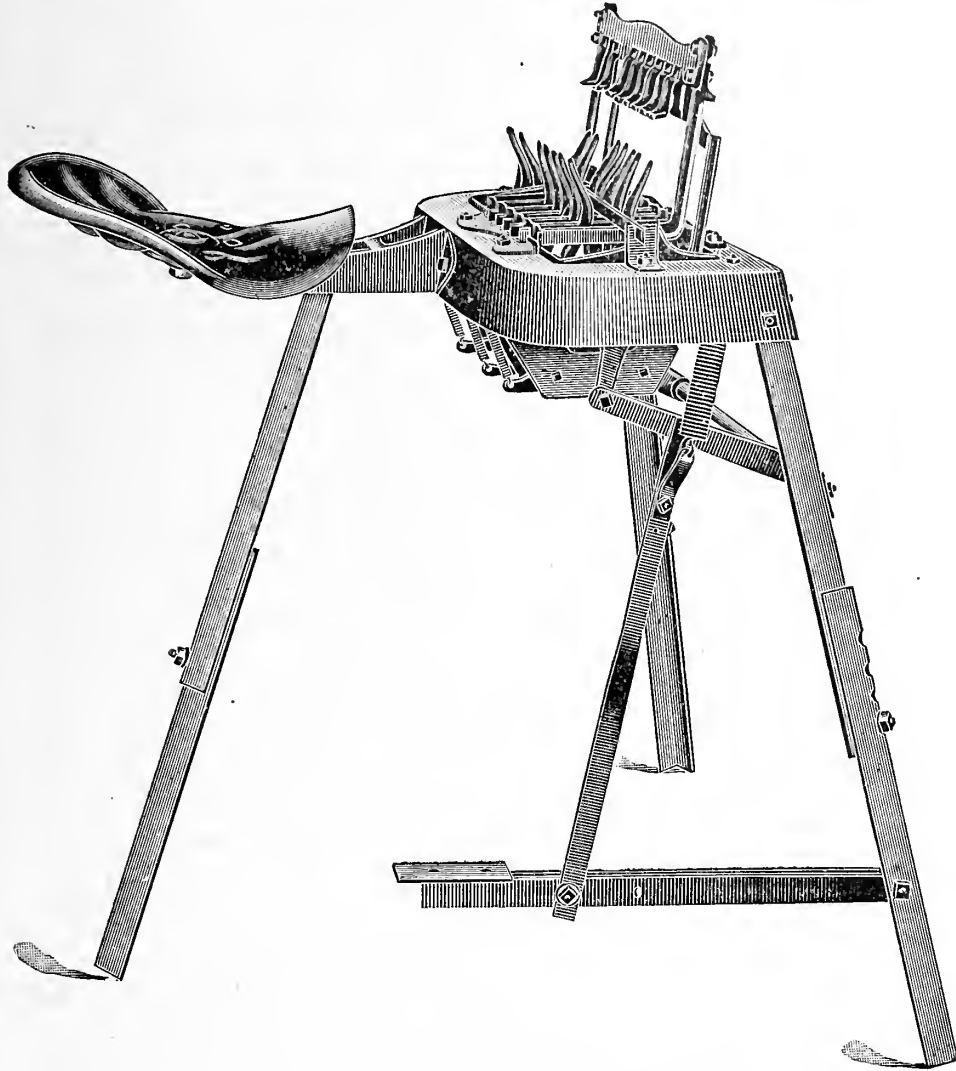

The Hoover Cutter meets the general demand for a first-class potato cutter.

Provision is made to cut either large or small potatoes into the proper number of pieces.

Knives are made of thin steel, and placed under tension, which holds them rigid and makes a clean cut without bruising the potato.

Pushing head swings directly over the potato before starting down, thus eliminating all side pressure on the potato while being cut.

Fingers for holding the potato are arranged so that both sides remain an equal distance from the center knife, which permits the potatoes being cut in equal sized pieces.

Capacity of this machine is one bushel every five minutes.

"BUCH'S No. 3" DOUBLE SPOUT CORN SHELLER

While this sheller is used principally as a hand machine, still it is admirably adapted for light power and is provided with a pulley just for that purpose. We have made a leader of this Sheller for several years, and recommend it to our customers as a Sheller excelling in the matter of convenience and up-to-date workmanship. The parts throughout are of selected heavy materials, made extra heavy and very strong. Well put together and nicely finished. Cold rolled steel shafts and steel shaker pitman. Journal boxes are made in two parts and can be adjusted to take up wear. This Sheller does rapid work, having a capacity of 500 to 600 bushels per day. Price, with shaker, \$32.00.

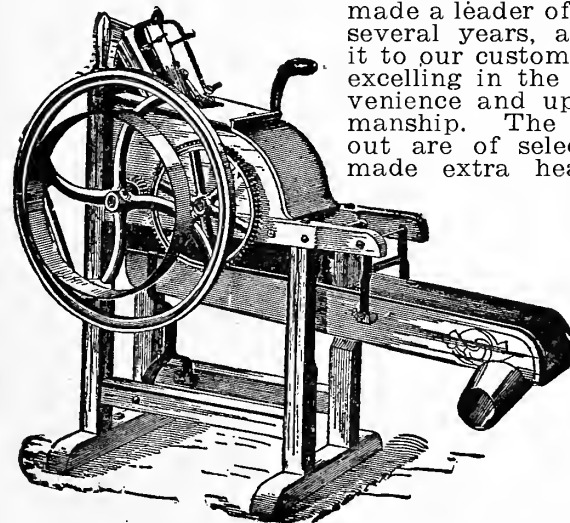

Price, with shaker, \$32.00.

"RED CHIEF" GRINDING MILLS

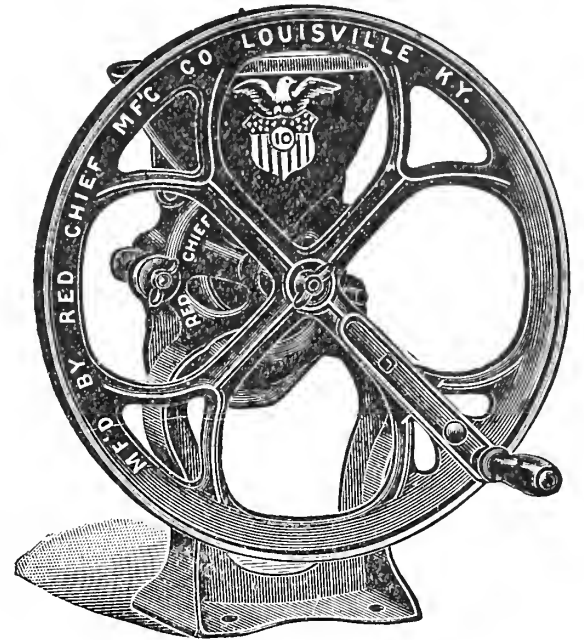

Does rapid work. Will grind meal or crack the grain any desired size. Strong, durable and neatly made.

- No. 1—Without flywheel.....\$ 4.00
- No. 2—With flywheel..... 5.50
- No. 5—Without stand..... 7.00
- No. 10—With stand..... 8.50
- No. 20—Combined Hand and Power..... 20.00

"BUCH'S No. 2" SINGLE SPOUT CORN SHELLER

This very popular Sheller is well made, light running, and will give good service. It has large balance wheel, with heavy rim and wrought-iron spokes. The journal boxes are engine bored and bolted to hardwood frames. Handsomely finished. Separates corn from cob. With sieve, \$13.00

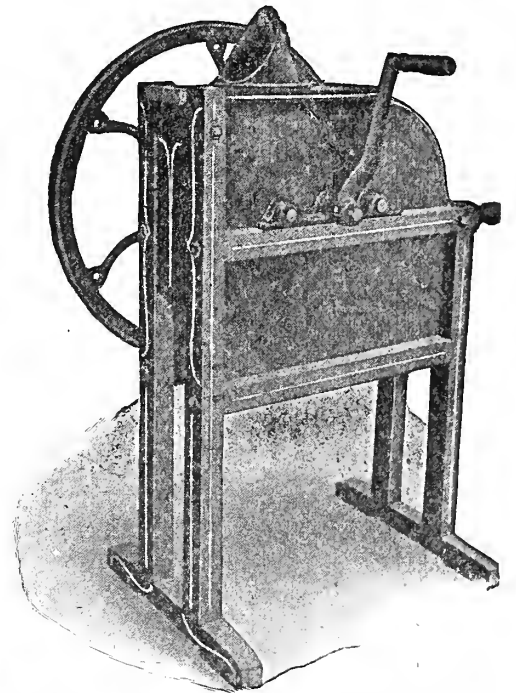

"RED CHIEF" CORN SHELLER

This is undoubtedly the best Sheller of its class. It has a suitable device for adjusting it to take either large or small ears, and do good work with either. It readily attaches to barrel or box, and is just the thing for persons who have but a small quantity of corn to shell. Price.....\$2.75

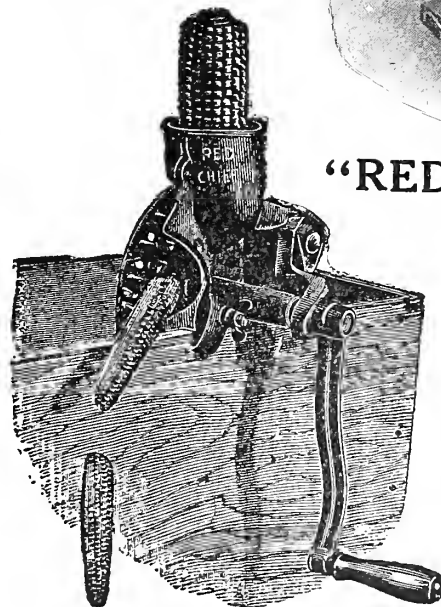

THE MYERS HAY UNLOADER, TRACK, FORKS AND FIXTURES

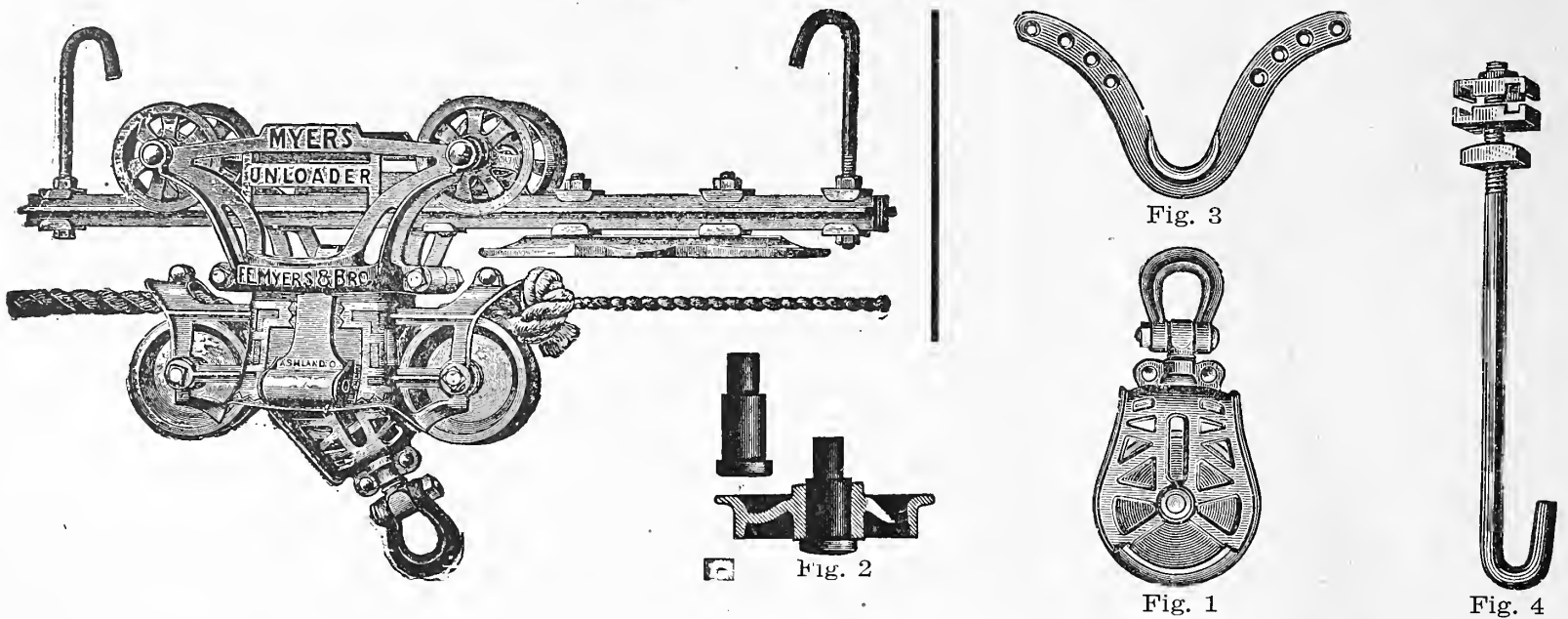

Patent Double-Lock Hay Unloaders, Patent Steel Tracks, Slings, Forks, Pulleys, Etc.

A test of thirty years has demonstrated the superiority of the Myers Hay and Grain Tools. They are now universally known and acknowledged to be the best, most practical, simplest in construction, and that they meet all the requirements.

A comparison of our carriers with others will show many points of superiority in our favor. These special features and advantages are covered by letters patent owned and controlled by us.

It is of the greatest importance that implements of this class, which are subjected to severe usage during the hurry of the haying season, should be thoroughly well built and constructed of first-class material throughout. The best malleable iron is used in the construction of our goods.

We give the above view of Myers Hay Unloader to be used on Myers Double-Angle Steel Track. This is the latest and best hay carrier, and it embodies all the features of the Straight Reversible and Swivel Reversible Carrier, and has many advantages over any other machine on the market. It is fitted with the Myers reliable double lock, which engages the fork pulley on each side, thus insuring a perfect locking device. One of the most important features of this carrier is the wide-open mouth, which permits the fork pulley to enter when swinging at any angle. This feature can be readily understood by referring to the illustrations above, and noting the shape of fork pulleys (Fig. 1). This construction insures a satisfactory working carrier under all conditions. The track wheels (Fig. 2) have turned steel axles, and weight is carried in center of wheel; the rope sheaves are fitted with wide hub and have longer bearings than any other make of carrier. For strength, simplicity, neatness of design and up-to-date features it is without a peer. We also offer the **Myers Unloader for Wood Track**. The Wood Track Unloader possesses all the good features of the Steel Track Unloader. Price, \$8.50.

MYERS PATENT STEEL TRACK

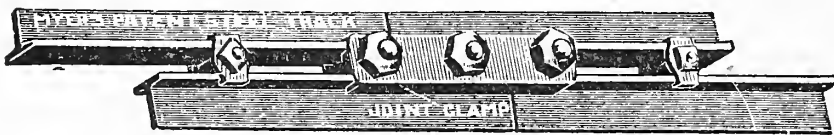

The style of this Track is here illustrated. It is made of two T carbon rails, very hard and stiff. Note the manner of clamping it together so that the two joints do not come opposite each other. A wrench only is needed to put this Track together. Price, per foot, 22c

PULLEYS, HOOKS, ETC.

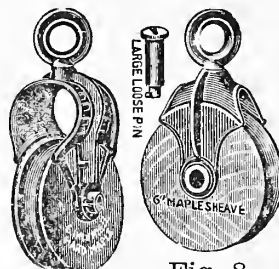

- Malleable Rafter Brackets (Fig. 3), each.....\$0.07
- Hanging Hooks (Fig. 4), each..... .16
- Floor Hook, 3/4-inch, each.. .18
- Plain Maple Sheave Pulleys (Fig. 8), each..... .55
- Knot-Passing Maple Sheave Pulleys (Fig. 7), each.... .75
- Rafter Nails, per lb..... .10

Manila Rope, either 3/4 or 5/8-inch diameter, at market prices, usually about 36c per lb.; about 5 feet to the pound.

FOOD COOKER AND BOILER

These are used for cooking food, rendering lard, scalding hogs, poultry, making soap; very useful for boiling spray mixtures. Heavy, cold-rolled steel furnace, extra-large feed door, wrought-iron handles, firmly riveted on furnace; kettles are smooth and made of heavy cast iron, never buckling or warping from heat. Made to set on ground or brick foundation.

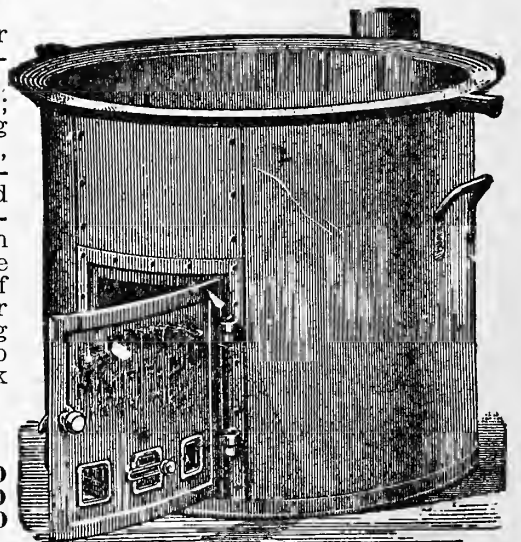

- Prices:**
- 30-gallon.....\$18.50
 - 40-gallon..... 21.50
 - 53-gallon..... 23.50

REGULAR DOUBLE-HARPOON FORK

Fig. 5
The best known Fork.
Price, \$2.50.

GENUINE NELLIS SINGLE-HARPOON FORK

Price, \$4.50.

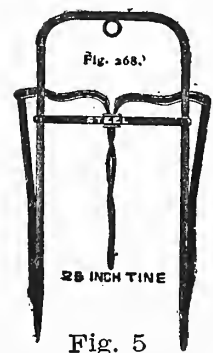

MYERS LOCK-LEVER FORK

(Fig. 6)

Has 50 per cent more capacity than the regular Double Harpoon Fork on account of the cross-bar being nearer the top. Operated with one lever. Price, \$5.50.

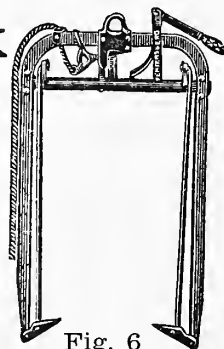

Special Estimates on Complete Outfits Cheerfully furnished

DOUBLE-CAGE CIDER MILL

These mills are made in three sizes, Junior, Medium and Senior. Capacity of Junior, 2 to 4 barrels per day; Medium, 4 to 6 barrels per day.

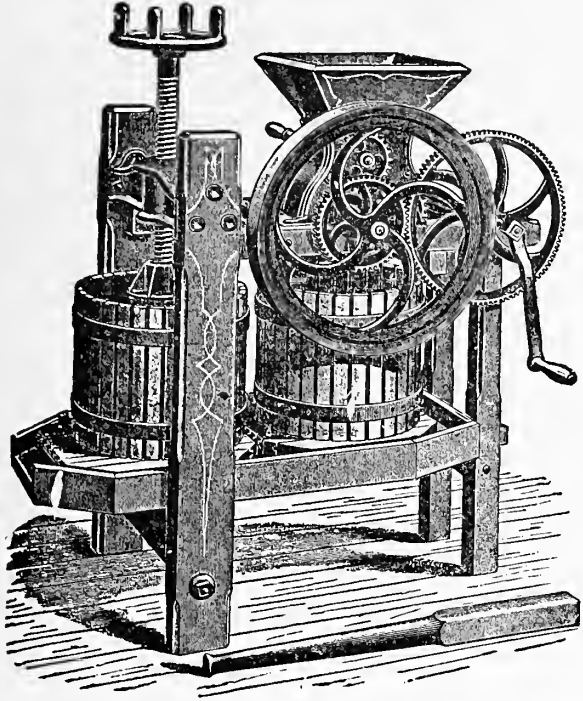

SENIOR

They have adjustable rollers and feed regulator and double crank. In these Mills the lower rollers are cast with alternate rims and grooves interlocking to draw in the apples. Fruit is mashed between the smooth segments, thoroughly breaking all the cells so that cider is entirely extracted in press. Balance wheels are heavy, and mill can be run by power. The mills are very strong. They are made of best material, nicely finished, and are easy to operate. Capacity, 6 to 12 barrels of cider per day. Weight, 390 pounds.

Prices:
 Junior (small) . . . \$30.00 Medium \$42.00
 Senior (large) \$48.00

"IAMIT" CIDER MILL

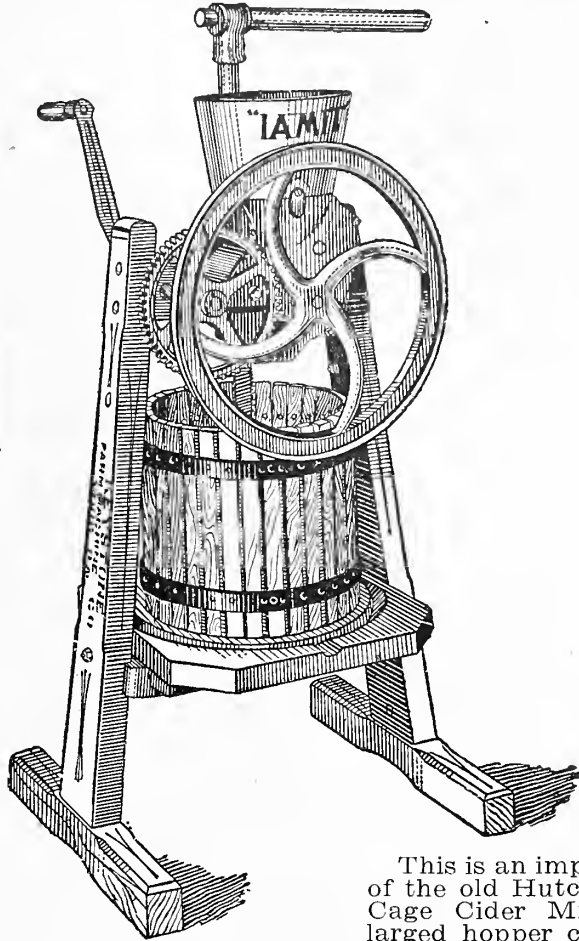

This is an improved pattern of the old Hutchinson Single-Cage Cider Mill. The enlarged hopper can be noticed by the illustration. This change is made to give a larger feed opening, as the small hopper and throat are the principal objections to the Hutchinson Mill. Equipped with a heavy fly wheel, which adds to the steadiness and ease with which it can be operated. Price \$25.00

BERRY PRESSES

For pressing juice from grapes and berries for wine it is a very handy machine. It is well made, of good material, and will do satisfactory work. Made in three sizes.

Prices:
 No. 1 \$ 7.75
 No. 2 9.50
 No. 3 15.00

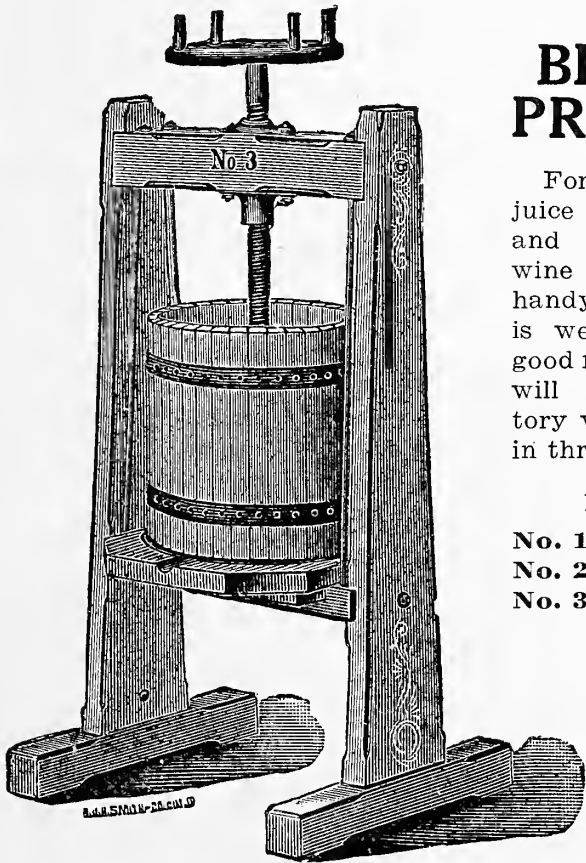

ENTERPRISE LARD AND FRUIT PRESS AND SAUSAGE STUFFER

Made entirely of steel, iron and tin. Thousands in use. Circular on application. No. 15, 2-quart; No. 25, 4-quart; No. 35, 8-quart. Prices on application.

WAGNER FRUIT AND LARD PRESS

These presses are very strong and durable. Having a large screw and long leverage makes them easy to operate.
 4-quart \$6.50 6-quart \$7.50
 8-quart \$8.00

REMOVABLE BASKET HANDLES

Easily and quickly adjusted. Saves fruit and time. Baskets carried without mashing fruit. Each 25c.

CAHOON'S BROADCAST SEED SOWER

For Sowing Clover, Timothy, Millet, Oats, Wheat, Hemp, Barley, Rye, Rice, Buckwheat, Etc.—Standard Seeder of the World—A Model for Accuracy and Durability—Malleable Iron Frame—Steel Hopper and Gate—Brass Discharger.

The breadth of the cast will be according to the weight of the seed. Wheat and rye, 30 to 36 feet; oats, 21 to 25 feet; barley, 27 to 33 feet; clover, millet, Hungarian seed, 20 to 24 feet; hemp, 27 to 30 feet; timothy, 15 to 18 feet.

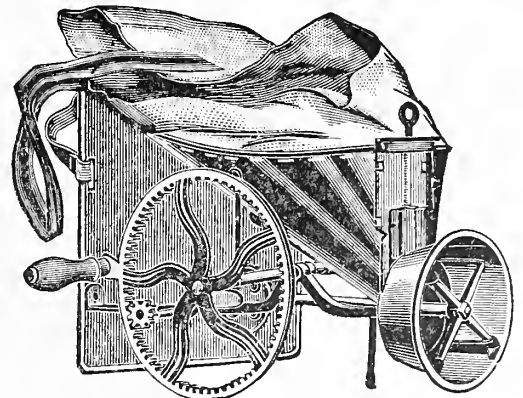

Our Special Price, \$6.00.
 Parcel Post weight, 8 pounds.
 WISCONSIN SEEDER \$4.00

SIX-ROW 100-GALLON TRACTION SPRAYERS

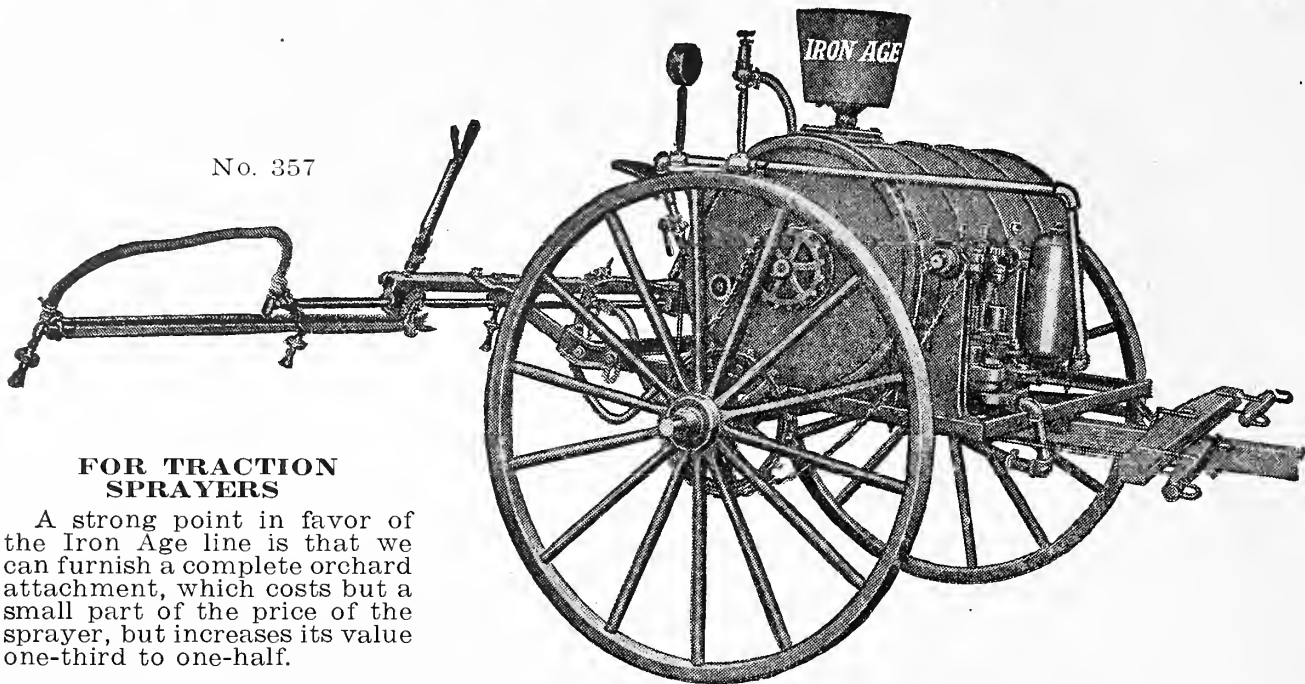

No. 357

FOR TRACTION SPRAYERS

A strong point in favor of the Iron Age line is that we can furnish a complete orchard attachment, which costs but a small part of the price of the sprayer, but increases its value one-third to one-half.

machine that covers six rows at high pressure is worth the difference in cost. It cuts the team travel one-third and covers the ground more than half again as fast as with the four-row sprayer on account of time saved in turning—a vital matter in these days of scarce labor.

No. 357—Here is a machine for the farmer who wishes to spray at the highest pressure obtainable from traction and to do it rapidly. The "Iron Age" Triplex Pump will deliver spray under a pressure of about 175 lbs. when operated from the wheels by traction. Just as the six-cylinder automobile runs more smoothly than the four, this pump will run somewhat more smoothly than the Duplex, as each plunger connects with the crank shaft at a different angle. This reserve power makes it a long-lasting pump.

Large acreages of potatoes demand quick work, and a

The trucker will find still another advantage in this six-row machine. Where he grows two crops together, such as tomatoes and peas, he can stop off every other nozzle so as to cover only one of the crops. **Price, \$215.00.**

MYERS UNIVERSAL PUMP JACKS

This very popular jack has been improved by the use of clean-cut gears. Can be attached to any windmill pump. Is equipped with 12-inch tight and loose pulleys. Back geared 5 to 1, and can be adjusted 5, 7½ and 10-inch. Price, **\$16.00**
Price, \$18.00.

Myers Self-Lubricating Pump Jack, engine driven, a novel device in which all gears and moving parts are enclosed in a one-piece casting, forming the Oil Reservoir. This construction not only insures perfect and continuous lubrication, but protects the moving parts from dust and dirt, greatly increasing the life of the jack. Furthermore, it guarantecs perfect safety.

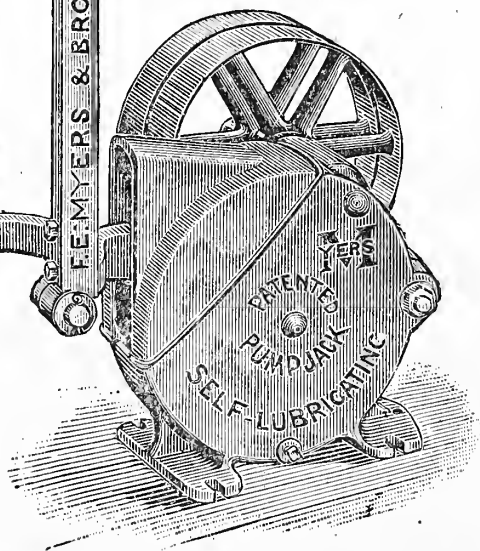
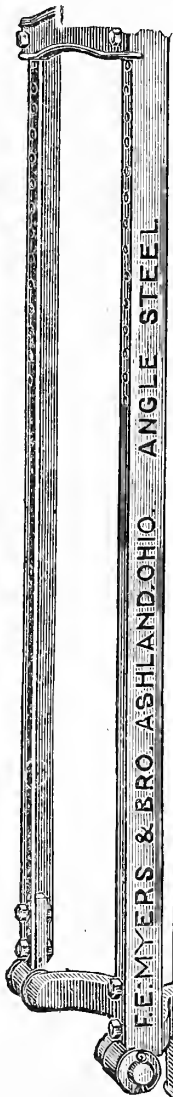

SIMPLEX PLATFORM SCALE

This is the best cheap-grade Portable Platform Scale on the market. It is intended for use where a Scale is only used occasionally, and is not subject to hard usage. The iron parts are finished in black japan, and the wood parts are painted blue, and are well finished.

The beam is carefully graduated and made of solid brass, with brass sliding poise. The leber and beam pivots are of steel drawn to a knife edge, and are supported in hardened bearing loops.

Each Scale is sealed to U. S. Standard weights, and is carefully packed.

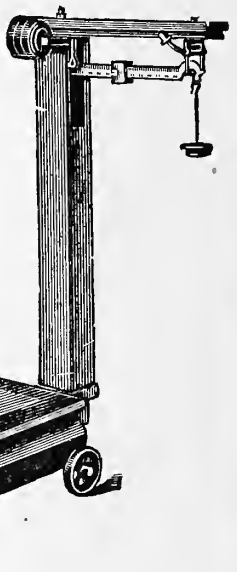

No. Capacity. Price.

- 94— 400 lbs. . \$30.00
- 95— 600 lbs. . 32.00
- 96— 800 lbs. . 37.00
- 97—1000 lbs. . 40.00

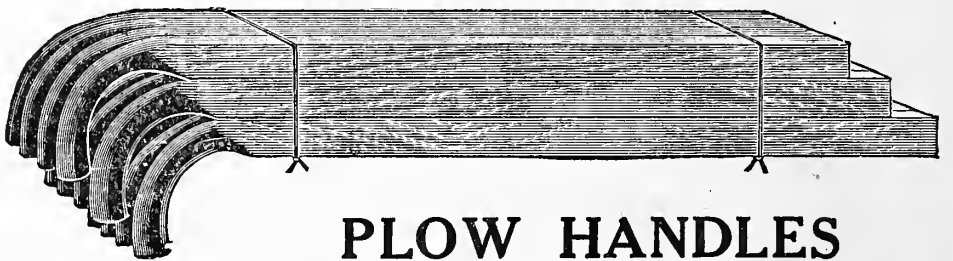

PLOW HANDLES

NOT FINISHED

- 1½x2 ins., 5 ft. long, per pair.....\$0.80
- 1¼x2 ins., 5 ft. long, per pair..... .90
- 1¼x2¼ ins., 6 ft. long, per pair..... 1.25
- 1½x2¾ ins., 5½ ft. long, per pair..... —
- 1½x2 ins., side bend, per pair..... —

WE CARRY A FULL LINE OF WOOD AND STEEL-FRAME GRINDSTONES

LEGGETT'S CHAMPION DRY POWDER DUSTER

For farm, garden, vineyard, tobacco fields, etc. Adjustable to any width of row. Many thousands in use. Distributes Paris Green, London Purple, Hellebore, Sulphur Lime, Dry Bordeaux Mixture, Dry Bordeaux Mixture and Paris Green Compound, Spanish Pink, Pyrethrum Powder, etc.

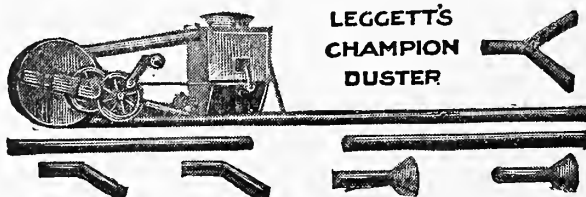

LEGGETT'S CHAMPION DUSTER

Dusts Potato Vines as fast as you walk, two rows at a time. Illustration shows tubing and nozzles. Any one can use it. Weighs, cased for shipping, 17 pounds.

This machine keeps the poison at a safe distance from the operator.

Price, \$15.00.

MYERS STANDARD BARREL SPRAY PUMPS, ETC.

For Hot, Cold or any Kind of Mixture—Has Mechanical Agitator, Solid Brass Ram Plunger, Ground Bevel Valve and Seat

MYERS O. K. SPRAY PUMP

The new Myers O. K. Spray Pump has a special clamping device that can be adjusted to any barrel, regardless of the height or width. The cylinder is what is known as a ram plunger, made of solid brass tube with a closed end, which passes through a circular hemp packing, which adapts it for pumping hot, cold or any kind of mixture. The packing gland has a simple and positive adjustment, by which all wear can be readily taken up. The valves can be easily taken out and repaired. The air chamber is made of 2 1/2-inch steel tube, the handle is wrought steel, with adjustable stroke, and the pump is fitted for two strings of discharge hose. Price of Pump, with 1 lead of 15-foot hose, 8-foot pipe extension and Vermorel or Bordeaux nozzle, including barrel, \$30.00.



No. 305 MYERS IMPROVED BARREL SPRAY PUMP

The entire Pump sets in the barrel containing the liquid and is bolted fast to the staves at the upper end. The working parts being all submerged, the possibility of losing packing is done away with. Valves and seats are ground brass, brass cylinder and discharging pipe, patent expansive bucket, large 30-inch air chamber. Vermorel or Bordeaux nozzle, mechanical agitator and pipe extension. \$24.00.



If mechanical agitator is not wanted, deduct 75c. If pipe extension is not wanted deduct 60c. This applies to Nos. 305 and 306 Pumps.

AUTO SPRAY No. 1

A Self-Operating or Automatic Sprayer.
Weight empty, 7 lbs. Weight loaded, 39 lbs.
Weight shipping, 15 lbs.

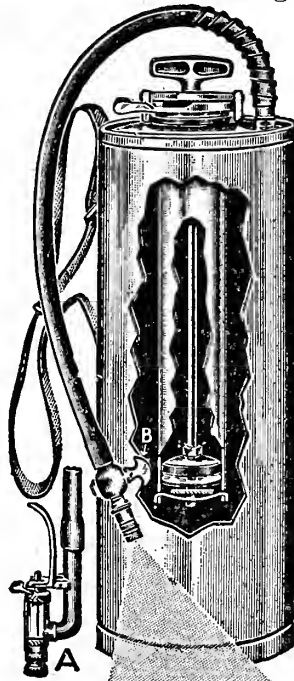

The Auto Spray No. 1 is one of the best on the market. It is very strong and practical. When properly charged contains three gallons of solution and one gallon of compressed air. Ten to twelve strokes of the plunger will compress the air, and two pumpings will empty the entire contents.

All parts which come in contact with solution are made of brass, and the handle and other parts are made of malleable iron. Length of cylinder, 21 ins.; diameter of cylinder, 7 ins.; capacity, about 4 gals.; weight empty, 7 pounds.

Auto Spray No. 1C—Galvanized Reservoir, Stop Cock.

Price.....\$6.00

Auto Spray No. 1D—Galvanized Reservoir, Auto-Pop.

Price.....\$6.50

Auto Spray No. 1A—Brass Reservoir, Stop Cock.

Price.....\$9.00

Auto Spray No. 1B—Brass Reservoir, Auto-Pop.

Price.....\$9.50

PATENTED. EXTRAS

- Auto-Pop Nozzles.....\$1.50
- Extension Pipe—
- Brass, 2-foot length, 60c; Galvanized..... .50
- Brass Elbow Extension..... .40
- Double-Row Attachment..... 1.50
- Brass Strainer for straining solutions used in Auto Spray..... 1.20

WHITEWASHING and PAINTING

Any Myers Barrel, Horizontal or Bucket Spray Pump is adapted to apply whitewash or fire-proof paint, provided it is fitted with a Bordeaux nozzle. One man with a good spray pump can cover more surface in a given time than five men with brushes.

LEVER BUCKET SPRAY PUMPS

Fig. 632 represents the Myers Lever Bucket Spray Pump, made of brass and fitted with brass valves and patented agitator. The cylinder is 1 inch in diameter with solid plunger. The air chamber is 50 per cent larger than the ordinary bucket spray pump, has malleable iron foot rest and malleable lever. This pump can be operated with one-half the power of the ordinary bucket spray pump, owing to the advantage of the lever handle. This pump can also be used as a barrel spray pump, the head having two holes in for bolting same to the barrel.

(Fig. 632)

We recommend a Bordeaux Spray Nozzle for whitewashing and painting. If you desire the Vermorel Nozzle instead of the Bordeaux, please specify.

No. R-324 Lever Bucket Spray Pump, with agitator, complete with hose, Bordeaux, coarse spray and solid stream nozzle. Price, \$7.50.

No. R-324A Lever Bucket Spray Pump, with agitator, complete with hose, Bordeaux coarse spray and solid stream nozzle and 8-ft. pipe extension. Price, \$8.00.

No. R-324B Lever Bucket Spray Pump, with agitator, complete with hose, Bordeaux, coarse spray and solid stream nozzle and 8-ft. pipe extension with stop-cock. Price, \$9.25.

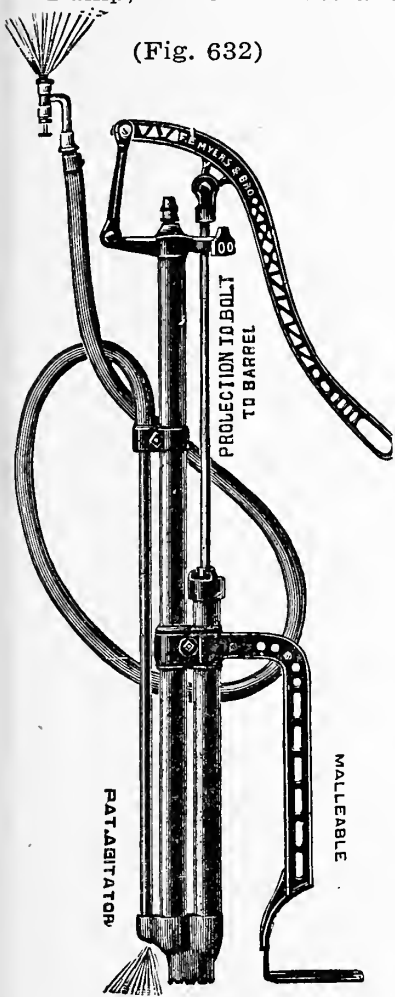

EXTENSION SPRAY RODS

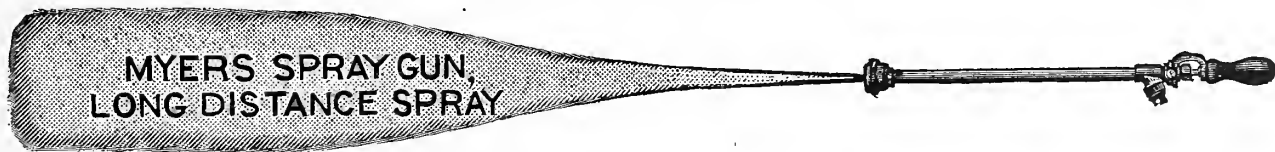

The idea to enable one man to do the spraying, thus saving the expense of two extra men as is the case with the ordinary spray rig using two lines of hose with bamboo extensions.

By a one-third turn of the handle the spray can be adjusted from a long distance spray reaching the top of the tree to an extremely broad spray sufficient to cover

the entire tree or shut off entirely.

It is furnished with four separate spray discs designed to deliver the entire capacity of the pump, either 4, 6, 8 or 10 gallons per minute.

One-third turn of the handle adjusts the spray from a wide open nozzle to a complete shut-off of the mixture. Price, \$6.00.

THE MYERS AUTOMATIC POWER SPRAY OUTFIT

FITTED WITH AUTOMATIC DUPLEX PUMP

The Automatic Pressure Governor insures safety. Secures uniform pressure and eliminates unnecessary wear. Relief valves not required.

[Fig. 1880

Patented

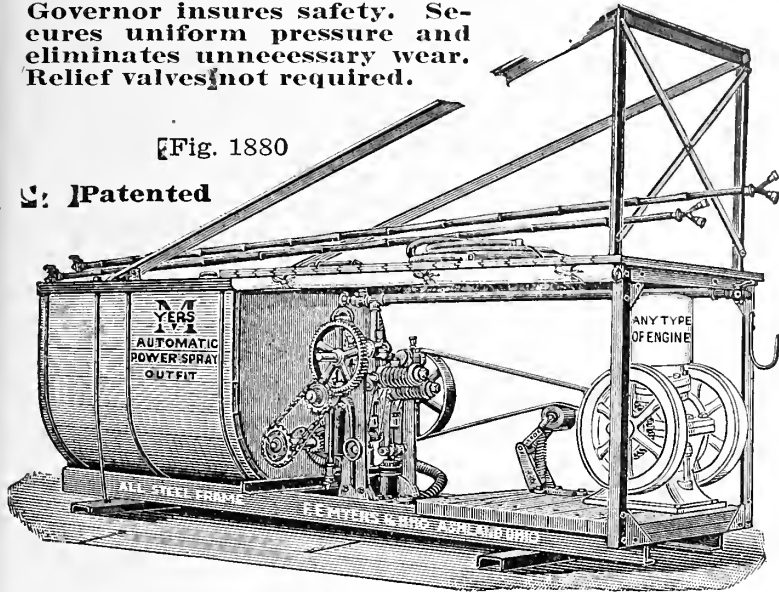
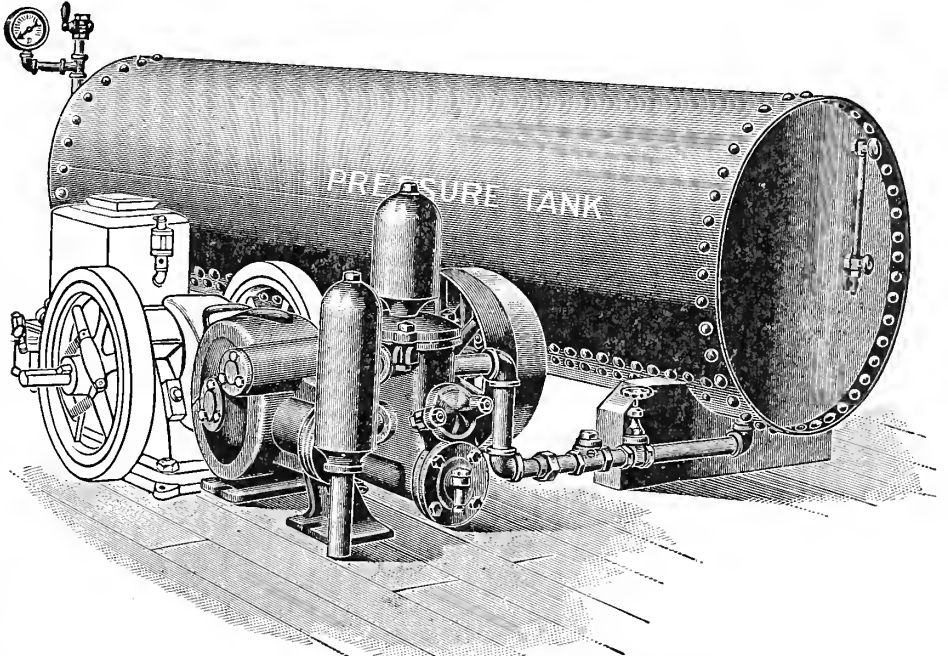

Fig. 1880 represents the Myers Automatic Spray Outfit, which is furnished complete, including hose, spray gun, pump, tank, agitator, etc.—in fact, everything with the exception of the engine and wagon truck. The pump is supported on channel bars riveted to the frame. The engine is mounted on a 2-inch plank platform, the object being to supply a construction that the consumer who is familiar with the use of the ordinary gas engine can set it on the rig and dismount when wishing to use it for other purposes without requiring the services of a machinist. The entire framework is made of channel and angle iron, making a very stiff frame with the least possible weight. The tank is made of selected cypress, is fitted with rotary agitator with wooden blades. The agitator is driven by bevel gear and link chain, which makes a flexible joint and relieves the tank from all strain. The frame is fitted with two cross-channel bars on the underside, which fit over the bolsters of the wagon, preventing forward or backward movement. The cab has heavy canvas curtains for protection of the engine and pump. The guard rails on top are to prevent the operator from falling off, and fold flat for transportation or storage. Price, less Engine and Truck, as shown in illustration, \$235.00. Price complete with Engine and Truck, \$350.00.

INVINCIBLE WATER SUPPLY OUTFIT WITH MYERS POWER PUMP AND GASOLINE ENGINE

The use of pressure tanks instead of elevated tanks for supplying water under pressure is becoming more and more universal each year. The pressure tank is nothing more than a heavy, carefully made air-tight steel tank, into which the water is pumped. When the tank is what is commonly called empty, it is really full of air. Into this tank which is full of air water is pumped, and as the air cannot escape from the tank, it is gradually compressed until, when the tank is two-thirds full of water, you have a back pressure from the air equal to that you would get from a tank elevated 100 feet. If a high-grade tank like those furnished with our **Invincible Outfits** is used and the connections properly made, you will have to pump new air into tank in very small quantities, the only reason for pumping air being to replace that which is absorbed by the water and drawn off. To replace this air different devices are used. Sometimes simply an air cock in the suction pipe of the pump, or a Hydro-Pneumatic Cylinder, or a separate air compressor, which devices are listed here. The advantages of a pressure tank system are its absolute reliability, its simplicity, and as these tanks are either placed in a cellar or buried in the ground, with the end extending into the cellar. The water is kept an even temperature, being neither very hot in Summer or freezing cold in Winter; this is a big advantage in watering stock. It does away with the necessity of having an elevated tank in house, which is undesirable, or an elevated tank on tower outside, which is frequently unsightly and very liable to freeze up in cold weather. Price on application.



The Proper Size Tank to Select—The proper size of tank depends upon the total water consumption and the method of pumping. If the pump is operated by electric motor where reliable current is available, a small tank will give comparatively good service. In a case of this kind, we would suggest a tank with a total capacity of twice the usual daily consumption, although if an automatic switch is used a tank with a total capacity equal to the daily consumption will give good service. Where an engine is used for pumping, we would suggest a tank of a total capacity of not less than twice the number of gallons used daily. In fact, we consider it better to use a little larger tank than this. When you are pumping by hand, we would suggest twice as many gallons capacity as the daily consumption, and if pumping by windmill, a tank with a total capacity of from four to six times as many gallons as are liable to be used daily.

Information Blank—We would be glad to mail on application to anyone interested in the installation of an **Invincible Water Supply Outfit** one of our special information blanks, which will enable you to clearly give the information which will enable us to intelligently recommend suitable equipment.

MYERS SELF-OILING BULLDOZER POWER PUMP

Self-Oiling. Fully Enclosed. Back Geared 5 to 1. Renewable Bearings "A." 100-Pound Pressure.

Floor Space:

2½x3 Pump.....	14x31 inches	4x5 Pump.....	24x46½ inches
3x4 Pump.....	18x37 inches	5x5 Pump.....	24x48 inches

For General Service.

Capacity 500 Gallons at 70 R. P. M.

No. 612—Myers Self-Oiling Bulldozer Power Pump with vacuum chamber, 2½x3 inches. Brass-lined cylinder, 12x2 inches. Tight and loose pulleys, 1½ inches. Brass piston rod, suction and discharge, 1¼ inches. Price.....\$56.70

Capacity 1,000 Gallons Per Hour at 70 R. P. M.

No. 613—Myers Self-Oiling Bulldozer Power Pump with vacuum chamber, 3x4 inches. Brass-lined cylinder, 14x2½ inches. Tight and loose pulleys, ½ inch. Brass piston rod, suction and discharge, 1½ inches. Price.....\$87.75

Send for Catalogue and Prices on Larger Sizes.

(Patent Applied For)

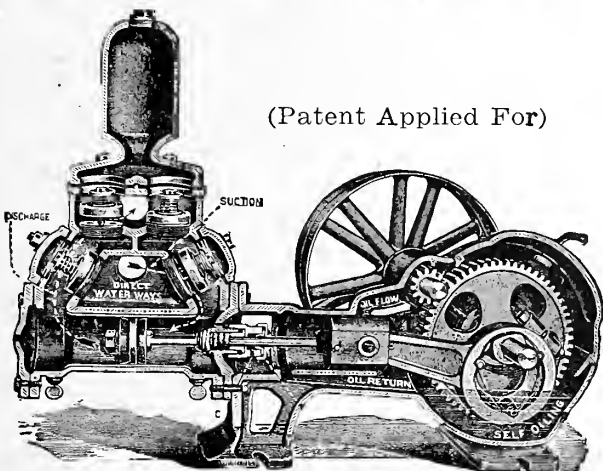

RED JACKET Double-Acting FORCE PUMP

“SO-EASY-TO-FIX”

Quality, Efficiency and Individuality, Rather Than Price

THEIR CONSTRUCTION AND ADVANTAGES

The **Red Jacket Double-Acting Force Pump** is so constructed that the lower or suction cylinder holds twice as much water as the upper or force cylinder, thus equally dividing the flow of water. Half of the capacity of the lower cylinder is discharged on the up-stroke of the plunger and the other half on the down-stroke. This steady, continuous motion causes the pump to work easier, and gives better results.

The **Red Jacket Double-Acting Force Pump** has an extra large and long air chamber, which serves as a cushion to the stream. This, in connection with the **equally-divided** flow of water, produces a **continuous, steady discharge** from the spout—a feature especially desirable for hand use.

By a simple arrangement at the base of the pump the upper cylinder, valves and all working parts can be easily drawn out through the base for repairs without disturbing platform, pump or pipe. An ordinary monkey-wrench and a very little time will do the business.

To secure satisfactory results, all pumps and cylinders must be kept in good repair, and the advantage of this “**Quick Repair**” feature cannot be overestimated.

The picture on this page “tells the tale.”

The “**So-Easy-to-Fix**” Compared with the “**So-Hard-to-Fix**” Pump.

All **Easy-to-Fix** pumps are fitted with wood sucker rod instead of steel rod. The buoyancy of the wood rod takes a dead weight off the handle and makes the pump easy to work. When steel rod is used, its weight must be lifted with every stroke of the pump—**SEE!**

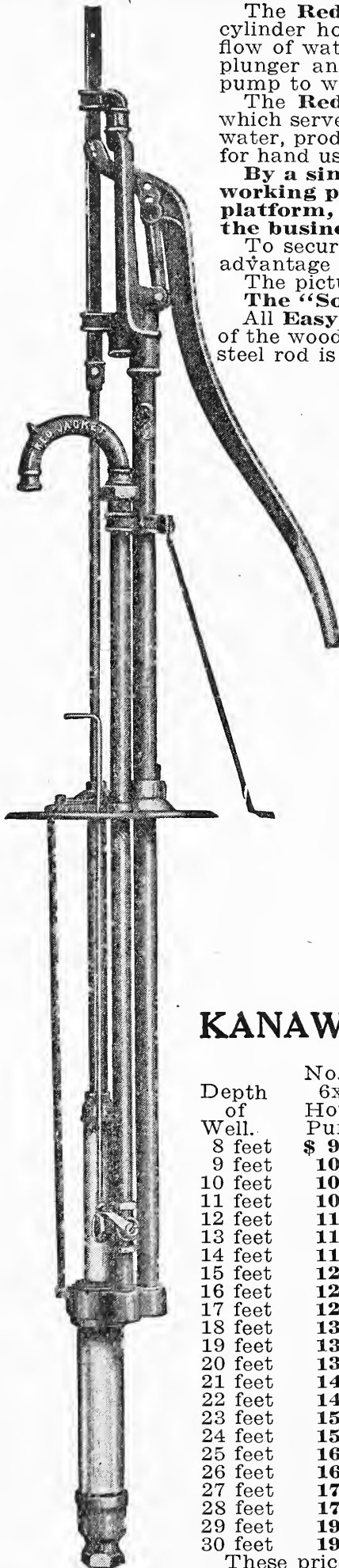

Fig. 73.

Depth of Well from Platform to the Bottom	Fig. 28 No. 1	Fig. 73 No. 1½	Fig. 102	Fig. 116
10 feet	\$28.50	\$38.25	\$81.25	\$40.00
12 feet	29.50	39.50	82.75	41.00
14 feet	30.50	40.75	84.50	42.00
16 feet	31.25	42.00	86.00	43.00
18 feet	32.25	43.00	87.50	44.00
20 feet	33.00	44.00	89.00	45.00
22 feet	34.00	45.50	90.75	46.25
24 feet	35.00	46.50	92.00	47.25
26 feet	36.00	47.75	93.75	48.25

These prices apply to Fig. 73 Pump.

Depth of Well from Platform to the Bottom	Fig. 51—7½ with 2-in. Pipe	Fig. 51—8½ or 59—202 with 2½-in. Pipe	Fig. 51—10½ or 59—203 with 3-in. Pipe	Fig. 116
28 feet	\$48.00	\$53.00	\$58.75	\$53.50
30 feet	50.00	55.75	61.75	55.75
32 feet	52.00	58.25	65.00	58.25
34 feet	53.75	60.50	68.00	60.50
36 feet	55.75	63.00	71.00	63.00
38 feet	57.50	65.25	74.25	65.25
40 feet	59.50	67.75	77.50	67.75
42 feet	61.25	70.00	80.50	70.00
44 feet	63.00	72.50	83.75	72.50
46 feet	65.00	75.00	86.75	75.00
48 feet	67.00	77.25	90.00	77.25
50 feet	69.00	79.50	93.00	79.50
Extra feet	1.00	1.25	1.50	1.25

KANAWHA PUMPS FITTED FOR WELLS

Depth of Well.	No. 2, 6x6 House Pump.	No. 5, 7x7 Farm Pump.	No. 7, 8x8 Stock Pump.	Depth of Well.	No. 4, 7x7 Pump Head.	No. 6, 6x6 Pump Head.
8 feet	\$ 9.90	\$11.85	\$17.05	31 feet	\$23.65	\$21.15
9 feet	10.20	12.10	17.35	32 feet	24.50	22.00
10 feet	10.45	12.35	17.60	33 feet	25.30	.85
11 feet	10.75	12.65	17.85	34 feet	26.15	23.65
12 feet	11.00	12.95	18.15	35 feet	26.95	24.50
13 feet	11.25	13.20	18.45	36 feet	27.75	25.30
14 feet	11.85	13.75	19.00	37 feet	28.80	26.15
15 feet	12.10	14.05	19.25	38 feet	30.00	26.95
16 feet	12.35	14.30	19.55	39 feet	30.80	27.80
17 feet	12.65	14.55	19.80	40 feet	31.65	28.60
18 feet	13.20	15.15	20.35	41 feet	32.45	29.45
19 feet	13.50	15.40	20.65	42 feet	33.25	30.25
20 feet	13.75	15.65	20.90	43 feet	34.10	31.10
21 feet	14.05	15.95	21.15	44 feet	34.95	31.90
22 feet	14.30	16.25	21.45	45 feet	35.75	32.75
23 feet	15.15	17.35	22.55	46 feet	36.55	33.55
24 feet	15.40	17.60	22.85	47 feet	37.40	34.35
25 feet	16.25	18.70	23.95	48 feet	38.25	35.20
26 feet	16.50	19.00	24.20	49 feet	39.05	36.00
27 feet	17.60	20.65		50 feet	39.90	36.85
28 feet	17.85	20.90				
29 feet	19.00	22.55				
30 feet	19.25	22.85				

Unlined pumps are not recommended.
For pumps fitted with Closed Bracket Handles add \$2.00.

These prices apply to the Wood Pump.

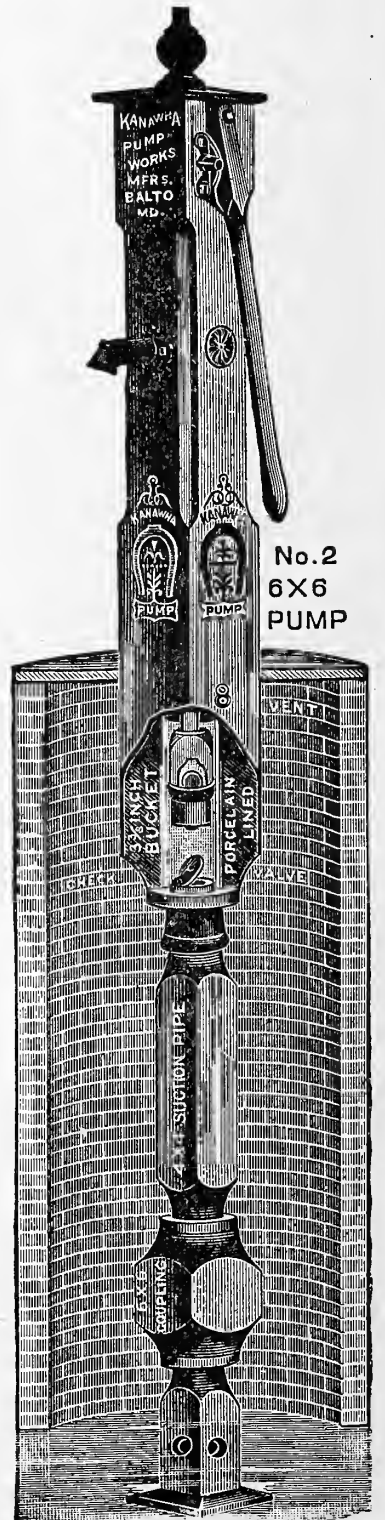

Hercules Drag Saw

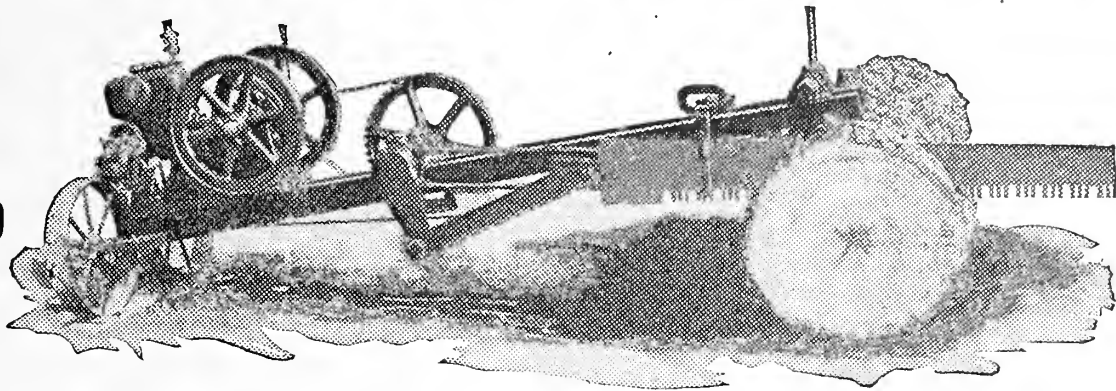

Price
\$125.00

Price
\$125.00

The outfit consists of a substantially constructed frame, mounted on two large steel wheels, a Hercules 1½ H. P engine and a powerful 5-ft. cross-cut saw capable of cutting through a 42-inch log.

In the designing and construction of this outfit, every care has been taken to insure safety and convenience to the operator. As will be seen, the saw guide handle and clutch are operated from the side opposite the saw.

The multiple-disc clutch, with which the engine is equipped, permits the engine to run while the saw remains idle and there is a lock chain to secure the saw and guide handle to the frame when moving the outfit for a new cut. A long continuous truss rod, extending from the front to the rear of the frame insures absolute rigidity and prevents vibration when saw is in operation. A special anchor hook firmly ties the frame to the log. The driving chain is a standard binder chain, such as is usually carried in all hardware stores, which makes the replacement of broken links a simple and economical matter.

A Hercules Drag Saw and one man will do as much work in one week as three men can do in a month with a hand saw, which is convincing proof that one of these outfits will be a profitable investment.

Write for special catalogue and names of users in this vicinity.

HERCULES GASOLINE ENGINES

The care used in building Hercules Engines—kerosene and gasoline—may best be seen from a careful study of the numerous features illustrated. Take, for instance, the engine base. Note the milled groove at the top and the tongue that is milled on the cylinder pad which fits into the base groove. These are both done on special

machines absolutely accurate, so that the tongue and groove fit together without any side play. This is a very important feature of the Hercules construction, as it makes it absolutely impossible for any side play of the piston or connecting rod. In addition to this accurately machined joint, the cylinder is held to the base by six heavy cap screws, three on each side. The main bearings are designed extra wide with large reinforced bearing stands. The bearing radius and sides are accurately machined in relation to the groove in the engine base, so that the crank shaft and connecting rod must be in absolute line with the cylinder bore. This reduces friction to a minimum, and means less wear, more power and longer life. Removable diecast bearings, made of high-grade babbit metal, are used in the bearing radius as a seat for the crank shaft. The Hercules governor is of the fly-ball type, with speed regulator, and we consider it much superior to the cheaply constructed flywheel governors. A steel pinion is used on the crank shaft to drive the governor.

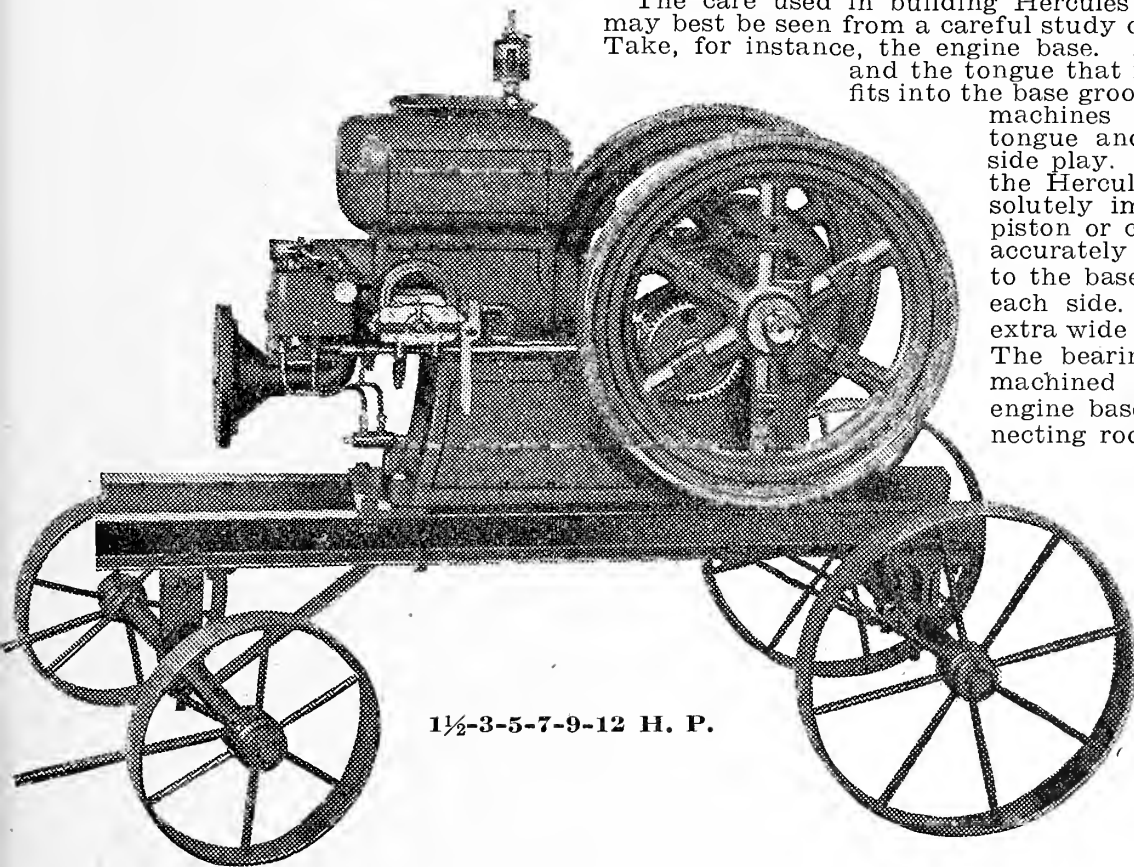

1½-3-5-7-9-12 H. P.

Style No.	Gas. Kero.	Speed		Plain Pulley		Fly Wheel		Floor Space Over All			Diam. of Crank Shaft	Ship. Wt.	Price.
		H.P.	R.P.M.	Diam.	Face	Diam.	Wt.	Width	Length	Height			
1½A	1½	550	4 in.	4 in.	18 in.	44 lbs.	27 in.	31 in.	19 in.	1¼ in.	320	\$ 70.00
3 A	K3A	3	475	8 in.	4 in.	22 in.	93 lbs.	26 in.	40 in.	22 in.	1⅜ in.	625	115.00
5 A	K5A	5	425	12 in.	6 in.	28 in.	165 lbs.	28 in.	47 in.	27 in.	2 in.	912	225.00
5-horsepower Portable Hercules Engine.....												285.00	
7-horsepower Portable Hercules Engine.....												335.00	

Send for Special Catalogue.

Best by Every Test

AMERICAN FARM FENCE

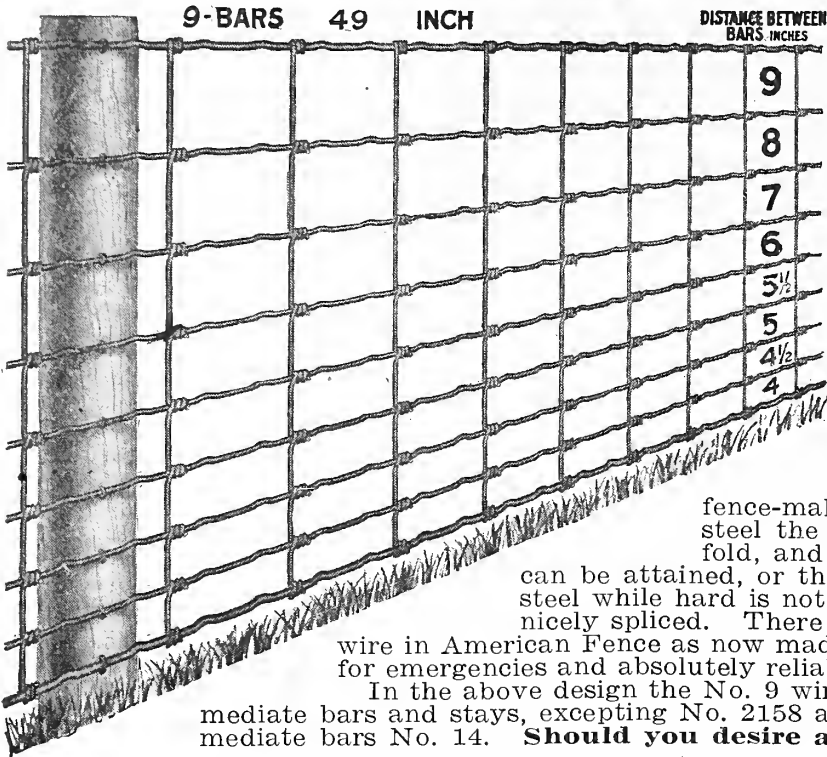

Made of large, strong, high-grade steel wire, heavily galvanized. Amply provides for expansion and contraction. Is practically everlasting. Never goes wrong, no matter how great a strain is put upon it. Does not mutilate nor injure stock.

URNS CATTLE, HORSES, HOGS AND PIGS

Every Rod Guaranteed by us and guaranteed by the manufacturers. Call and see it. We can show you how it will save you money and fence your fields so they will stay fenced.

MATERIAL

Hard, Stiff Steel—The development of American Fence, the years of experiment and hundreds of thousands of dollars that have been put into the work of perfecting machinery and producing the grade of special steel that makes American Fence what it is today would be a long story. Suffice it to state that about one year ago we succeeded in producing a composition in steel that for

fence-making is simply par excellence. By the use of this special steel the value of American Fence to the user is increased many fold, and we firmly believe it to be as near absolute perfection as can be attained, or the necessities of the case demand. Wire drawn from this steel while hard is not brittle. It is stiff and springy, but pliable enough to be nicely spliced. There is such a distinction as live steel and dead steel. Every wire in American Fence as now made is a live wire, doing business all the time, always ready for emergencies and absolutely reliable.

In the above design the No. 9 wire is used for top and bottom bars, No. 11 wire for intermediate bars and stays, excepting No. 2158 and No. 2053, which is top and bottom No. 11 and intermediate bars No. 14. **Should you desire any other style Fence, write for booklet.**

Design.	Bars.	Height.	Stays.	Price per Rod.	Design.	Bars.	Height.	Stays.	Price per Rod.
726	7	26-inch	6-inch	\$0.70	949	9	49-inch	12-inch	\$0.69
726	7	26-inch	12-inch	.50	2053	20	53-inch	6-inch	.92
635	6	35-inch	12-inch	.48	2153	21	58-inch	6-inch	.97
845	8	45-inch	12-inch	.61					

CYCLONE ORNAMENTAL GALVANIZED LAWN FENCE

The Style F Cyclone Lawn Fence is considered by us the most attractive and most practical pattern made by the factory, and we catalogue this style exclusively. The manufacturers make a number of other styles special circulars of which we will be pleased to send you on application. The characteristic features of Cyclone Fence are the careful uniformity of the weaving, the full-gauge wires which are used, the extra-deep crimping of picket wires, which adds greatly to the beauty and strength of fence, the secure manner in which these pickets are locked in the double cable wires and the general strength of the whole fabric. The wire is carefully selected, and all of these features count for the extra-lasting qualities of Cyclone Fence. With every full roll of Cyclone Fence a fence stretcher is furnished gratis. The lawn, the yard and the home are given the appearance of comfort and attractiveness by the use of a first-class wire fence, and from a sanitary and healthful standpoint, a wire fence is far more desirable than the old-style board fence.

DIAMOND MESH POULTRY NETTING

The wire we offer is No. 20 Double-Twist 2-inch Mesh, thoroughly galvanized. Sold in bales of 150 running feet.

(Galv. After Weaving.)				List Price,	Retail Price,
No.	Ins. Wide.	Sq. Feet.	Per Bale.	Per Bale.	Per Bale.
20	12	150	\$ 2.14	\$1.60	
20	18	225	3.08	2.30	
20	24	300	3.92	2.95	
20	36	450	5.35	4.00	
20	48	600	7.13	5.35	
20	60	750	8.91	6.70	
20	72	900	10.69	8.00	

(Galv. Before Weaving.)				List Price,	Retail Price,
No.	Ins. Wide.	Sq. Feet.	Per Bale.	Per Bale.	Per Bale.
20	12	150	\$ 2.14	\$1.45	
20	18	225	3.08	2.10	
20	24	300	3.92	2.65	
20	36	450	5.35	3.65	
20	48	600	7.13	4.85	
20	60	750	8.91	6.05	
20	72	900	10.69	7.25	

Price, 1 1/2c per square foot in less than bale lots. Staples for fastening, 10c per pound.

One-Inch Mesh.

(Galv. After Weaving.)				List Price,	Retail Price,
No.	Ins. Wide.	Sq. Feet.	Per Bale.	Per Bale.	Per Bale.
20	12	150	\$ 4.95	\$ 3.75	
20	18	225	7.12	5.35	
20	24	300	9.08	6.85	
20	36	450	12.38	9.30	
20	48	600	16.50	12.40	

THE LOTT STRETCHER

The simplest cheapest and most efficient tool ever gotten out for stretching fence. It is strong enough to stretch from 10 rods to a mile of fence at a time. Any body can operate it.

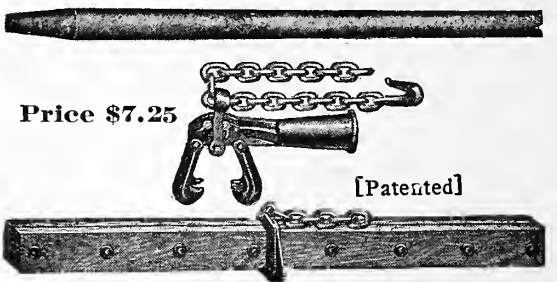

POST-HOLE DIGGER—(See Index.)
TOWNSEND WIRE STRETCHER—\$1.50.

WIRE STAPLES—Broad and narrow.

BARB AND RIBBON WIRE—Price on application.

AMERICAN WALK GATE

- 3 feet by 50 inches, \$4.25.
- 4 feet by 42 inches, \$4.75.
- 4 feet by 50 inches, \$5.00.
- 4 feet by 58 inches, \$5.50.

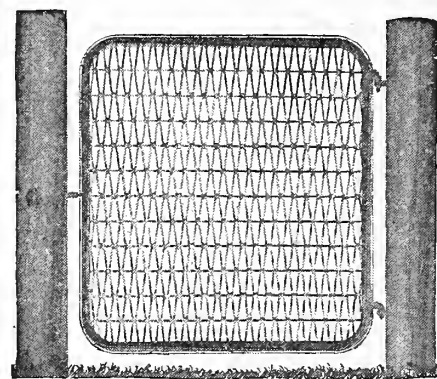

AMERICAN SINGLE DRIVE GATE

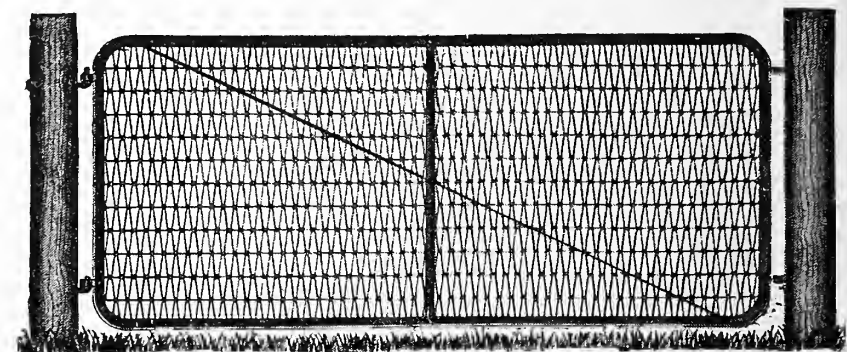

- 10 feet by 50 inches.....\$10.50
- 12 feet by 42 inches..... 11.00
- 12 feet by 50 inches..... 11.50
- 14 feet by 50 inches..... 13.50

Prices on Other Size Walk, Single-Drive Gates Furnished on Application

GEHL ENSILAGE CUTTERS

Here are seven of the many big reasons why the Gehl Cutter should be your choice:

1. The Gehl is constructed to cut properly.

The knives are of special steel, ground on the inside, spiral in shape, and giving that downward shearing cut. The only way to produce, and to continue to produce, uniform and perfect ensilage.

2. The Gehl is built for speed. Its large open throat and automatic feeding roller make it unnecessary to have a man at the feeder. These features help materially in giving the machine its great capacity, and make it very easy to feed.

3. The Gehl, on account of its independent control of the blower, knives being ground on the inside, its six-arm blower fan and triple bearings on main shaft, is rightly known as the LIGHT-RUNNING GEHL.

4. The Gehl Cutter, on account of its convenient independent control of cutter head and blower speeds, never wastes power on low silos; never falls down on high silos. The speed of the blower can be easily regulated on the job without interfering with the capacity by simply exchanging the blower and idler pulleys.

5. The triple construction of the heavy steel frame, the five long, well-babbitted bearings on the main and blower shafts, the malleable iron knife heads and center-hung blower drum, make it strong and durable.

6. The Gehl, with its positive break-pin safety device, quick-acting safety and reverse lever and automatic feeding device, never injures an operator—cannot blow up. It is, above all, a SAFE machine to operate, and saves a man's time at the feed table.

7. The Gehl Cutter can be equipped with the most practical and convenient meal-making attachment on the market.

Complete Catalog Sent Upon Request—Whatever you do, don't buy an ensilage cutter before you get the Gehl Catalog or talk to a Gehl dealer, and find out all about the wonderful advantages of Gehl Cutters. Write today for complete catalog.

Any form of dry roughage can be reduced to a meal by the use of this attachment. Savings in feed due to this practice run as high as 50 per cent. as in the case of corn. Most of the feed value of corn fodder lies in the stalk, which the cattle do not eat. Grinding to a meal releases the food value of all parts of the plant, puts it in such

condition that it is palatable to any animal on the farm. Another saving comes from the fact that the feed is never trampled under foot and wasted. Gehl Cutters are being used for this purpose all over the United States, cutting alfalfa, dry corn stalks (corn, cob and all), pea-vine hay, clover hay, velvet beans with pod and all, etc. The illustration on the left shows the device which can be attached to any recent model Gehl Ensilage Cutter, converting it into a first-class alfalfa and feed grinder. It can be quickly put on or removed from the cutter, thus making an ensilage cutter and feed grinder of the same machine. This attachment consists in part of a sheet-steel screen, which encloses the cutter knives and does not complicate the machine in any way, being very easy to put on and take off. It produces a meal of just the right granulation and does not require additional knives, shafting, bearings, pulleys, sprockets or chains, which means that the minimum power is required to operate. The knives are set to cut the hay or roughage into quarter-inch lengths, but because of the irregularity of feeding, the hay is not cut evenly. The knives force the small pieces through the screen, recut these pieces into shorter lengths, and the feed comes out cut in regular and convenient lengths.

This device can be used only by owners of recent models of Gehl or Silberzahn Cutters.

Take particular notice that a regular Gehl Silo Filler can be quickly converted into a special alfalfa or feed grinder by using the feeding attachment illustrated.

Some of Our Users—Brooklandwood Farms, G. H. Hibberd, manager, Lutherville, Md.; Miss Eleanor Fitzgibbons, Laurel, Md.; G. Bernard Fenwick, Glyndon, Md.; McDonogh School, Mr. Chase, manager, McDonogh, Md.; C. Wilbur Miller, I. H. Hartman, manager, Cockeyville, Md.; Sister of Notre Dame College, Eugene Leight, Glenarm, Md.; George C. Van Dusen, Laurel, Md.

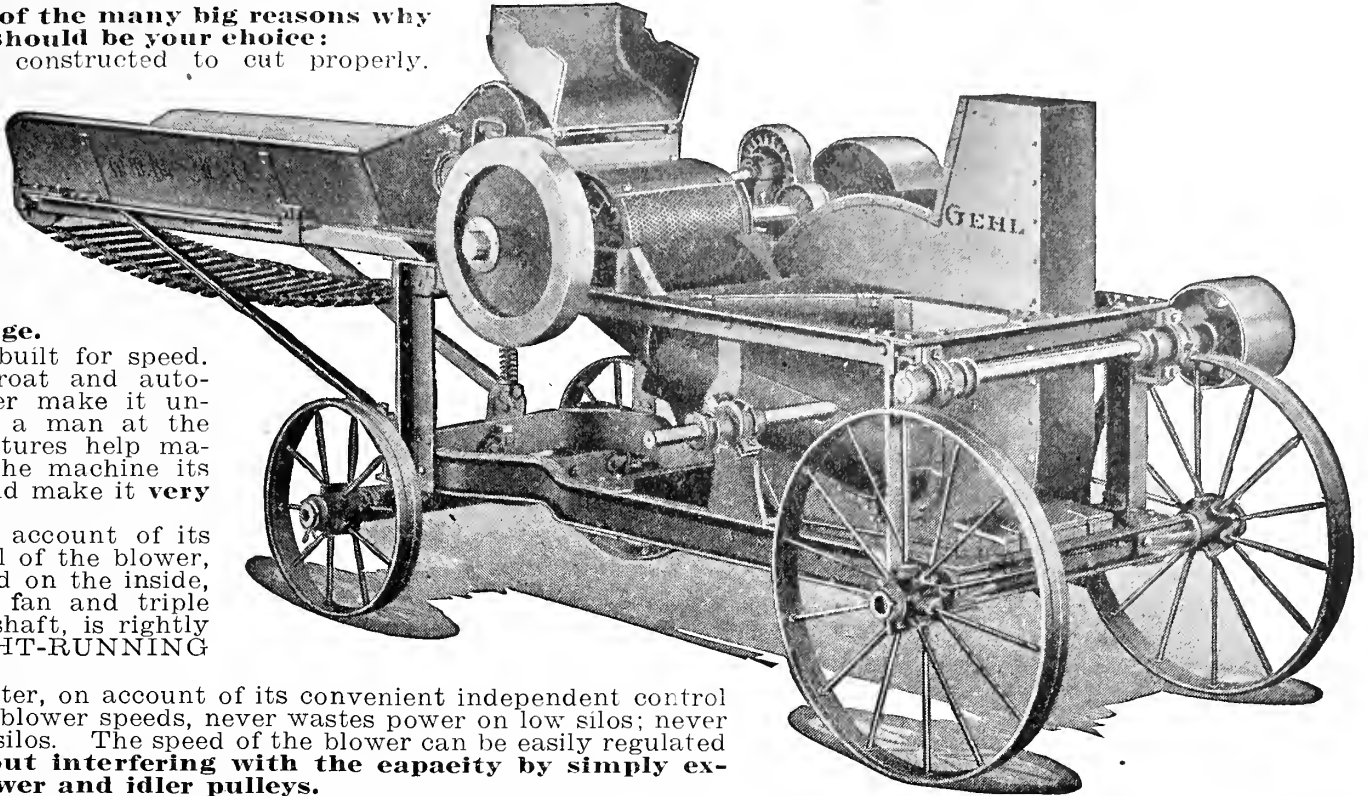
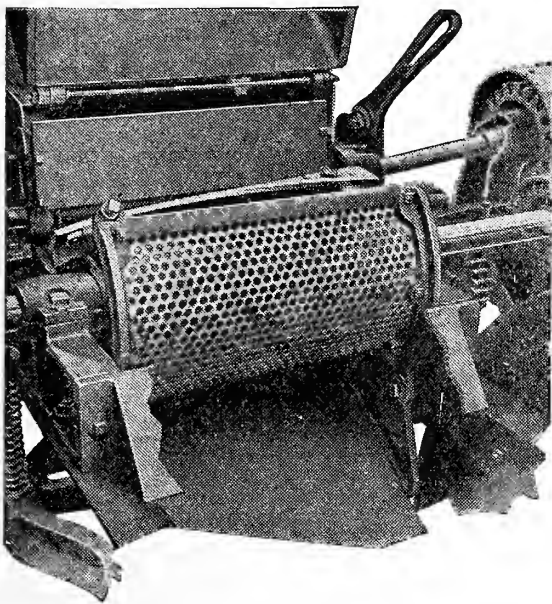

THE CUTTER THAT REQUIRES NO MAN AT THE FEED TABLE—ABSOLUTELY SELF-FEEDING Specifications for Ensilage.

No.	Length of Knives.	Capacity.	Power Required.	Weight.
13S	13 inches	4 to 8 tons per hour	5 to 8 horsepower	1,470 pounds
17	17 inches	10 to 15 tons per hour	10 to 12 horsepower	2,200 pounds
19S	19 inches	12 to 20 tons per hour	12 to 15 horsepower	2,340 pounds
24	22 inches	16 to 30 tons per hour	15 to 20 horsepower	3,380 pounds

We will be glad to send a sample of alfalfa meal produced by one of our machines upon request.

No. 13S—Portable Cutter.....\$290.00
For Alfalfa Grinding Screen add \$16.00.
No. 17—Portable Cutter..... 385.00
For Alfalfa Grinding Screen add \$20.00.

No. 19S—Portable Cutter.....\$475.00
For Alfalfa Grinding Screen add \$24.00.
No. 24—Portable Cutter.....\$600.00
For Alfalfa Grinding Screen add \$30.00.

Knife-Grinding Attachments for above Machines, \$15.00.

All Prices Subject to Change Without Notice

INTERNATIONAL ENSILAGE CUTTERS

Four to 6 horsepower runs the Type F Capacity 3 to 6 Tons Per Hour.

The Type F is built for average individual needs—for the man with the average engine of 4 to 6 horsepower.

International Ensilage Cutters get the most out of your men, power, horses and time. There are five sizes—one for your exact needs—and of every size there is every adjustment and convenience needed for quick, economical filling. They fill easily and do not choke; they elevate ensilage into the highest silos with ease, and are safe. Each will save you a lot of power, keep your men busy hauling fodder, require little or no hand feeding, and it will be always dependable.

Do your own filling—own your own cutter—be independent of others in the corn harvest. That is the modern tendency and the profitable one. And we have the economical cutter line—**International**. See us about it.



There has long been a demand for just such a silo filler, and here it is. At 800 to 1,000 R. P. M. of the flywheel it will elevate the ensilage thirty feet or better with ease. The flywheel being built of boiler plate, it is safe at any speed, and heavy enough to insure uniform cutting and high throw without extra exertion on the part of the engine.

REGULAR EQUIPMENT

Has steel flywheel. Regularly mounted on trucks with tongue, with traveling conveyor, flexible joint for allowing proper tilt of pipe in difficult settings, deflector with adjustable section, and two sets of straight knives—one set on the flywheel and one set in the tool box, together with wrench for adjusting them. Pulley lagged. Brackets provided for carrying feed table when detached. One is shown at right in illustration above.

SPECIAL EQUIPMENT

Hand feed and extension feed table leaf. Extra knives (straight only) and shredder bars—flywheel takes either two or four knives or two or four shredder bars, which can be used independently of each other. Distributor and blower pipe also extra.

SPECIFICATIONS—INTERNATIONAL ENSILAGE CUTTERS—TYPES F AND G

	TYPE F	TYPE G
Capacity (based on half-inch cut).....	3 to 6 tons per hour	8 to 10 tons per hour
Speed, R. P. M.....	800 to 1,000	800 to 900
Power (kerosene).....	4-6 horsepower	8 to 10 horsepower
Length of cut, two knives.....	1, 13-16, 3/4, 15-32, 7-16, 3/8-inch	Same as for Type F
Length of cut, four knives.....	1/2, 13-32, 3/8, 1/4, 7-32, 3-16-inch	Two knives only
Throat, width.....	9-inch	11-inch
Throat, height.....	3-inch	5-inch
Main Shaft, diameter.....	1 1/2-inch	1 3/4-inch
Pulley, covered (regular).....	6-inch face, 8-inch diameter	8-inch face, 10-inch diameter
Pulleys, covered (special).....
Pipe.....	6-inch diameter	7-inch diameter
Knife Wheel, diameter.....	30-inch	36-inch
Truck Wheel, steel.....	22-inch	22-inch
Weight, mounted, with hand feed.....	1,300 pounds	1,375 pounds
Weight, mounted, with conveyor.....	1,180 pounds	1,418 pounds
Weight, unmounted, with hand feed.....	870 pounds	1,116 pounds
Weight, unmounted, with conveyor.....	925 pounds	1,159 pounds

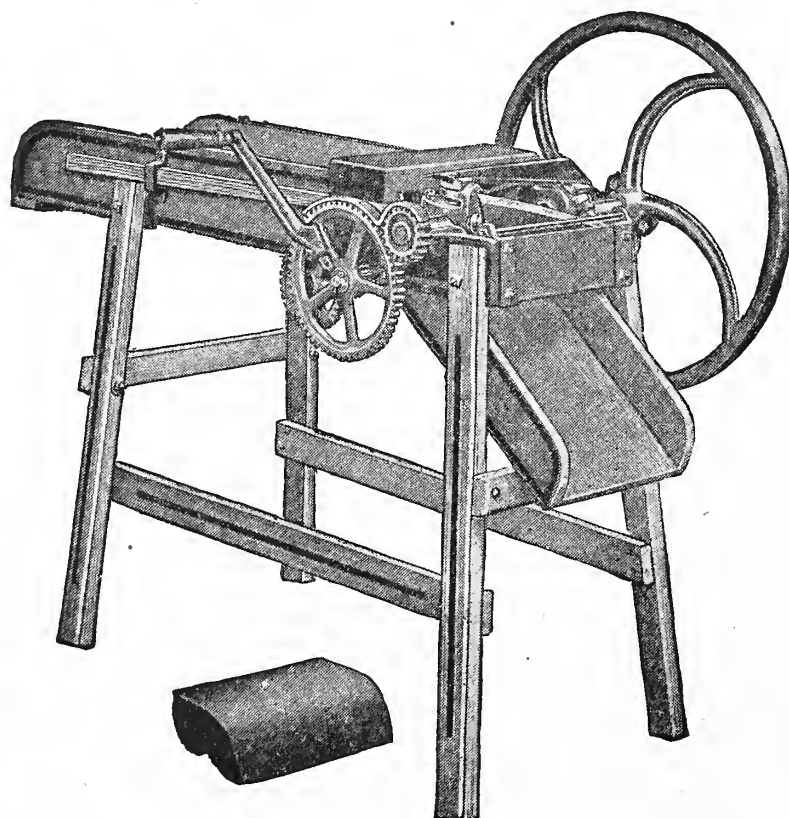

CYLINDER TYPE HAND CUTTERS

No. 11 1/4—"ONE KNIFE"

Ratchet feeding device, which can be adjusted to cut from 1/4 inch to 2 inches; has wooden side springs for feeding rolls, large heavy flywheel, long-reach crank, babbitted bearings, hardwood frame, securely bolted. A strong, easily operated box for cutting hay and fodder; has one knife, 11 1/4 inches long, with a chilled shear plate, ground to an edge.

Price, \$20.50.

No. 11 1/2—"TWO KNIFE"

The feeding rolls on the cutter are operated by means of cog wheels and sprockets. The feed is constant and uniform, and the cutter has large capacity. The feed rolls are equipped with coil tension springs; the cutter has large heavy flywheel, large crank, chilled shearbar and hardwood frame. Length of cut, 1/4 inch, 1/2 inch and 1 inch. Special gears for cutting 1/8 inch can be furnished on order.

Price, \$26.50.

McCORMICK AND DEERING MOWERS

Every PART Readily
ACCESSIBLE.

RENEWAL of PARTS Can
Be QUICKLY MADE

on All

McCORMICK MOWERS.

QUICK-ACTING LEVER

a Decided

ADVANTAGE.

Most Any BOY Can
OPERATE a McCORMICK

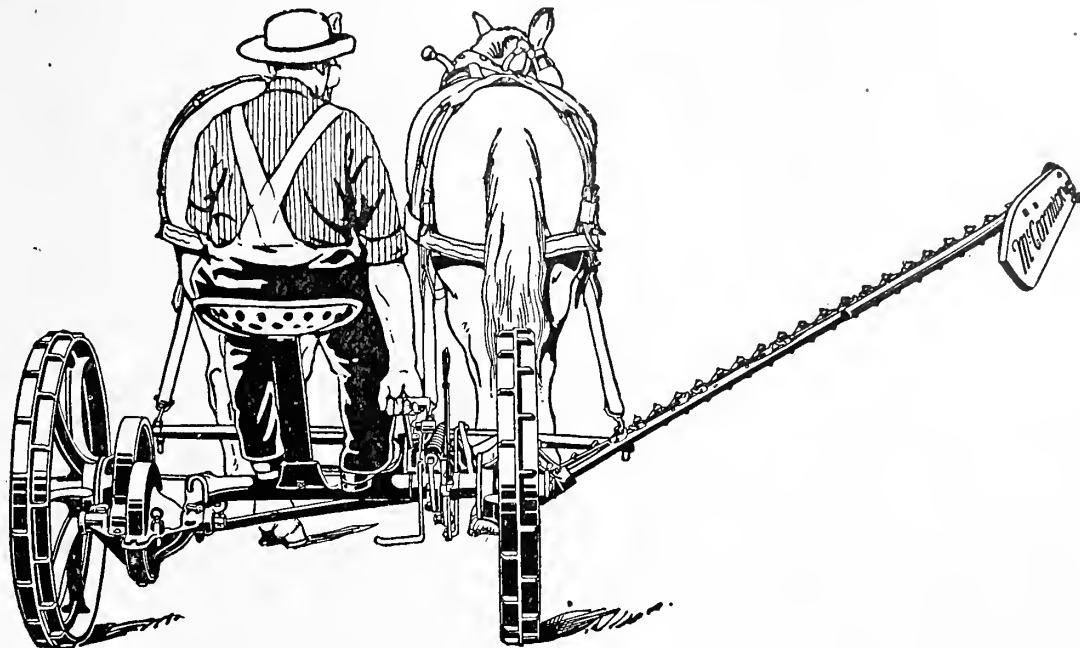

MANY REASONS FOR LIGHT DRAFT

Other than convenience for the operator himself, the farmer nowadays is anxious to get machines that are also easy on the horses or tractor. There are many good reasons why the McCormick Mower is easy to pull. Among these reasons is the flexible gag arrangement; in other words, it is the mechanism that holds the cutter bar in its position. This mechanism on the McCormick Mower is so made that when the cutter bar is raised with the hand lever in the first notch, as shown in illustration, there is only a slight angle between the pitman and the knife. When the cutter bar is raised to the position, which is fully twice as high as with most mowers, the angle between the pitman and the cutter bar remains practically the same. A mechanism that makes possible such a wide range of cutter bar lift is in itself sufficient reason for buying a McCormick Mower.

DEERING MOWERS

DEERING NEW IDEAL MOWERS are made in the following sizes:

1-horse regular lift, 3½-foot.

2-horse regular lift, 4½ and 5-foot.

1-horse vertical lift, 3½ foot.

2-horse vertical lift, 4½ and 5-foot.

DEERING GIANT MOWERS are made in 4½, 5, 6 and 7-foot sizes, 2-horse regular lift only.

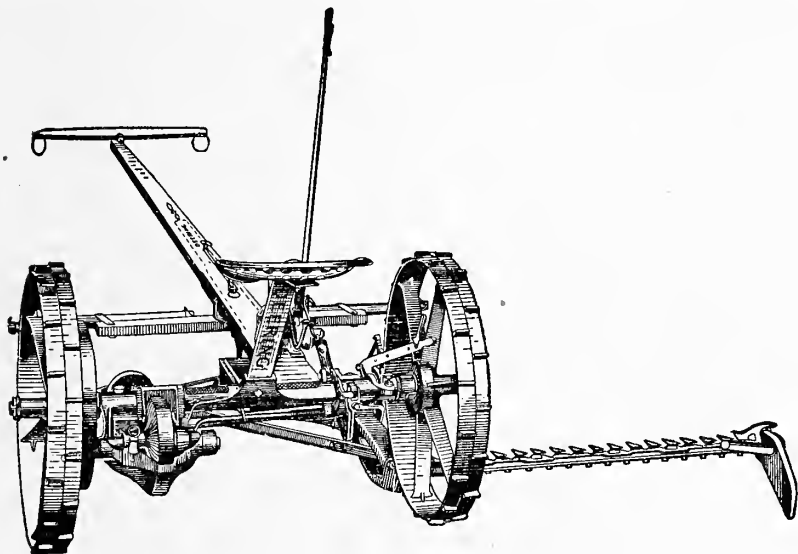

EVERY ADJUSTMENT WITHIN EASY REACH

Every adjustment that is necessary to make while cutting hay can be made by the driver without leaving his seat. The clutch can be thrown in and out with a foot lever near the seat spring. The large lever directly in front of the driver raises and lowers the cutter bar, as does also the foot lever shown in the accompanying illustration and already described. The small lever at the right of the driver tilts the var up and down so that the guards can be made to clear rough places.

The tension on the spring that counterbalances the cutter bar is subject to adjustment. The levers also have devices to take up play, so that the mower can be kept in satisfactory working condition throughout its entire life.

Any man who has cut hay on rough or stumpy ground knows what a tiresome thing it is to have to raise the cutter bar frequently in order to clear some obstacle. It is not always convenient to drive with one hand while the other handles the lever that raises and lowers the cutter bar. This inconvenience is overcome in the Deering by the foot lever that raises the outside end of the bar 19 inches, sufficient for all ordinary cutting, and still leaves both hands free. The weight of the cutter bar is counterbalanced by a heavy spring so that raising it is comparatively easy.

EITHER OF THE ABOVE MOWERS, \$75.00.

Send for Special Catalogue.

LINK CHAIN BELTING

No.	Links per ft.	Av. Ult. strength lbs.	List price per ft. all plain links	Retail per link	No.	Links per ft.	Av. Ult. strength lbs.	List price per ft. all plain links	Retail per link
25	13.3	700	15c	3c	52	8.	2300	20c	5c
32	10.4	1100	15c	3c	52½	7.9	2866	29c	6c
33	8.6	1190	15c	3c	55	7.4	2200	18c	5c
34	8.6	1300	15c	3c	62	7.25	3100	25c	6c
35	7.4	1200	15c	3c	65	7.66	2460	21c	6c
42	8.75	1500	17c	4c	72	5.9	4240	33c	8c
45	7.4	1600	15c	3c	72½	7.25	4590	43c	8c
48	6.	1660	17c	4c	76½	5.8	3890	31c	8c
50	8.7	1900	20c	5c	77	5.2	3600	33c	9c
51	10.4	1900	21c	6c					

Best by Every Test

McCORMICK AND DEERING RAKE

McCormick and Deering Rakes Are Made in Four Sizes—8, 9, 10 and 12-Foot

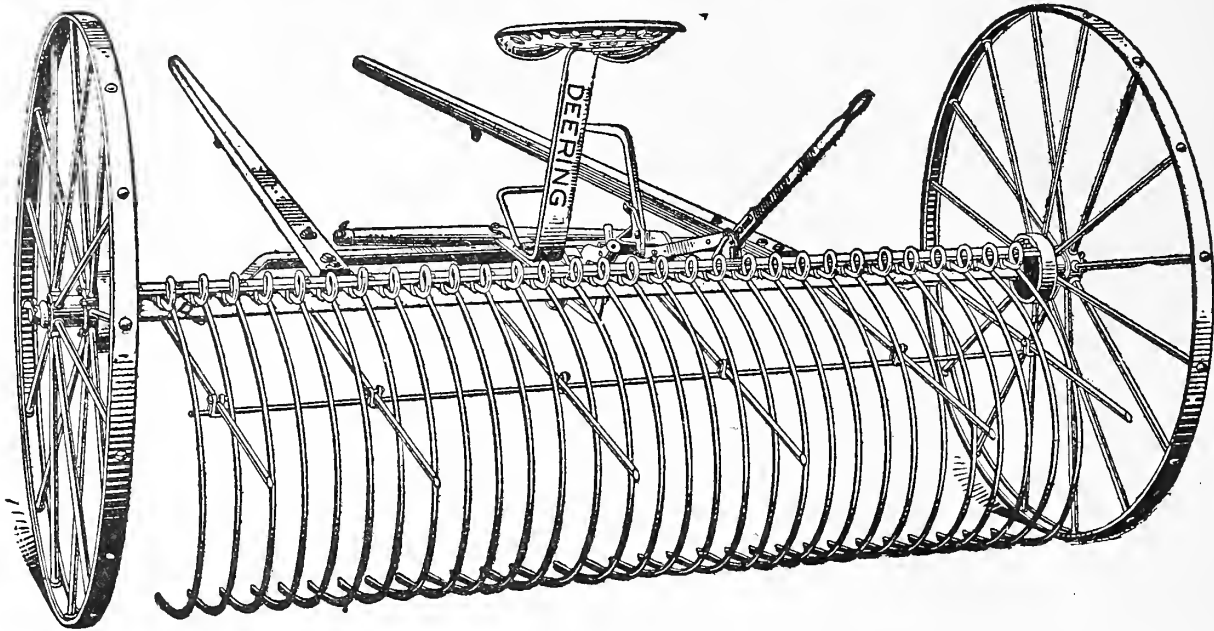

A hay rake is naturally long and unwieldy to handle. For this reason it is necessary to have exceptionally strong wheels and a rake head and axle that are absolutely sag-proof. The Deering Hay Rake has unquestionably the strongest wheels of any hay rake made and the rake head and axle never sag, no matter how long the rake may have been in use. The reason for the exceptional strength of the wheels is in the large, round staggered spokes and the channel rim, which make it impossible for wear to loosen the spokes in the rim. The hubs are wide, giving an exceptionally wide stagger to the spokes. The wheels are interchangeable, giving the advantage of two wearing surfaces in one wheel. The channel rim, in addition to affording a protection to the rivet heads of the spokes, prevents the rims from picking up dirt and dropping it down on the axle. Self-dump.

8-foot.....\$38.00 9-foot.....\$40.00 10-foot.....\$50.00 12-foot.....\$48.00

Deering Self-Dump Rakes Leave a Clean Field

Steel Construction Throughout

The Deering New Ideal Self-Dump Rake is of steel construction throughout. It is built so strongly that it will stand up successfully under the roughest usage and the hardest work to which it may be subjected in the field. The best angle steel is used in the construction of the frame, the different parts being hot-riveted together, instead of being bolted, as in many other rakes. This eliminates the danger of the bolts becoming loose or the nuts being lost in the field.

The operation of the rake is simple. It can be dumped by hand if desired or can be made to dump automatically by pressing a foot lever.

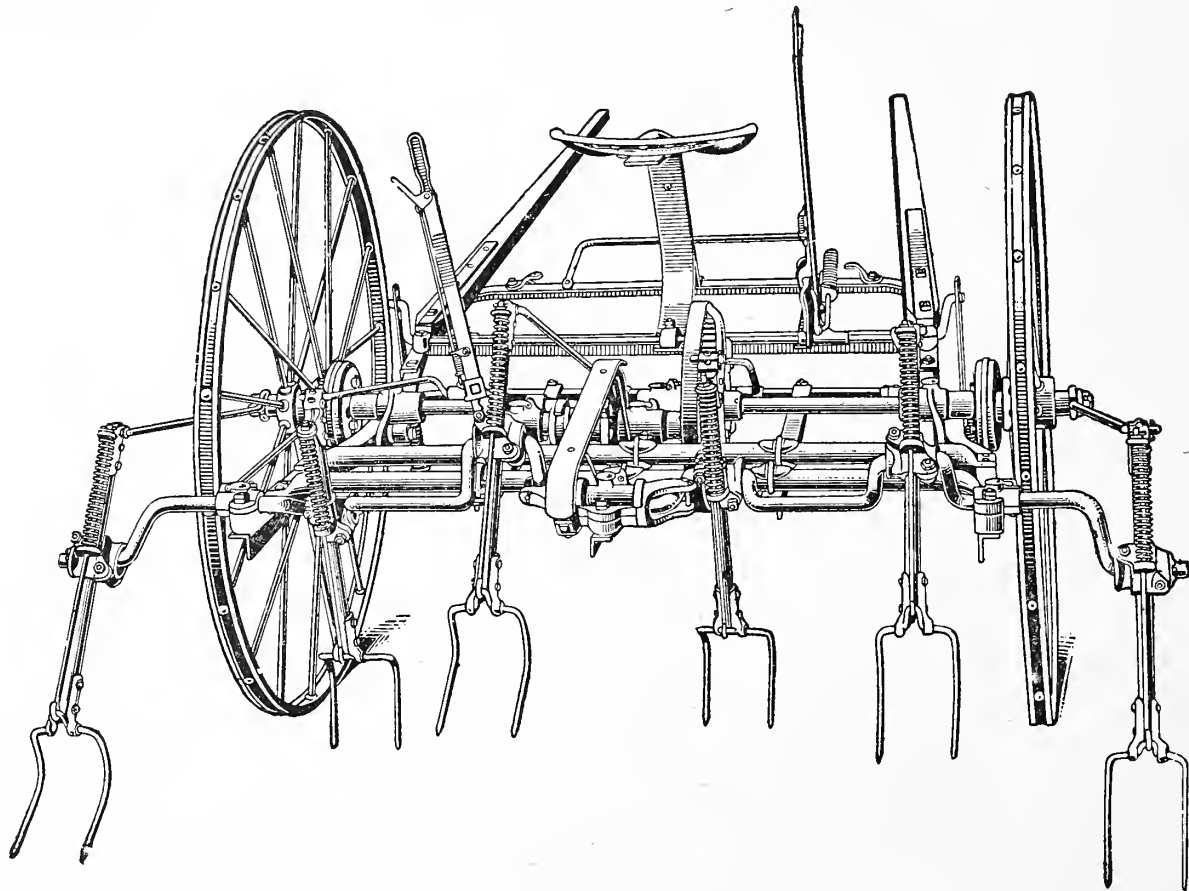

There is no haying machine a farmer can have that will return him as much profit, if judiciously used, as the Hay Tedder. This is particularly true in heavy hay crops and when the hay is cut early. There isn't any question but that hay, to be cured properly, must have light and air circulate through it. The leaves and blossoms cure much more quickly than the stems, and the hay that is on top cures quicker than that underneath. If the hay is left to dry in the swath the surface cures quicker. It has long been an established fact that hay curing on a cloudy day, with little dampness in the atmosphere, is of a much better quality than that cured when the sun is shining hot. The reason for this is that on a cloudy day the heat of the sun is eliminated to a large extent, thus giving the hay a chance to cure more evenly. The Hay Tedder takes the place of the cloudy day.

6-fork.....\$65.00 8-fork.....\$70.00

All Prices Subject to Change Without Notice

KEYSTONE SIDE-DELIVERY RAKE

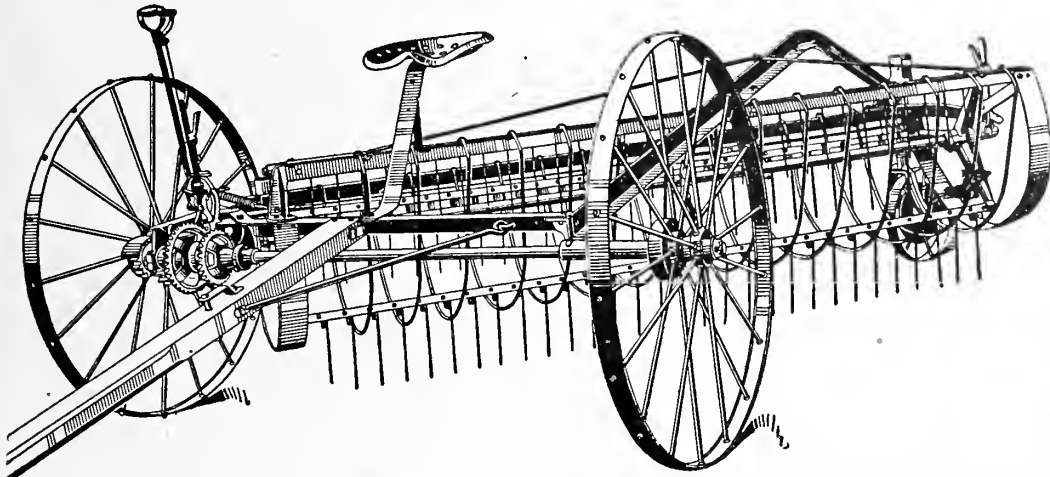

A Keystone combined Side-Delivery Rake and Tedder turns the hay over into loose, airy windrows, where it will air-cure thoroughly. This rake is built almost entirely of steel. Made in two widths, regular (raking 7 feet 3 inches wide) and bean special (raking 8 feet). The truss beam running over the cylinder gives great strength, yet leaves ample clearance for the hay.

You can rake the hay while the leaves are still active. By so doing, the leaves and heads which are left on top of the swath by the mower are kept from drying before the stems. They thus draw the moisture from the stems and insure even curing.

The rake works against the heads. This, together with close spacing of the teeth, insures clean raking.

The hay is placed upon clean stubble. The windrow is loose and airy, and the hay is so turned that a large part of the leaves are within the

This Rake is Built Almost Entirely of Steel. Note the Truss Beam Running Over the Cylinder. It Adds Great Strength. windrow while the stems are out. Therefore, by this method the hay would be air-cured instead of sun-dried.
Cylinder type, one castor wheel. Price..... **\$100.00**
Combined Side-Delivery Rake and Tedder, one castor wheel..... **105.00**
Extra castor wheel for either, **\$5.00.**

KEYSTONE HAY LOADERS

DOES FINE WORK

This loader will handle the heaviest windrows in the gentlest possible manner and deliver the hay on the wagon without the threshing of the leaves and heads. This makes it especially valuable in handling alfalfa or clover, the leaves of which are easily broken off. When it is desired to harvest the crop with all possible speed the hay can be raked into extra-large windrows and the Keystone windrow loader will pick it up and deliver it on the wagon in good condition.

The Keystone is very easy to hitch. The forecarriage is equipped with a latch and arms which do away with the necessity of backing the wagon to one exact spot. It is easily unhitched, too—by simply pulling the latch release rope from the top of the load.

VERY EASY TO OPERATE

It would be impossible to design a more simple hay loader than the Keystone windrow. There are no gears or drive chains on it, the entire mechanism consisting of the gathering drum, which gathers the hay and at the same time operates the elevator carrier. There is no drag in turning the corners, for the drum is ratcheted to both wheels, also insuring uniform action when the wheels are passing over dead furrows and uneven ground. The drum is strongly constructed of steel, and has eight pipe steel tooth bars on which the spring steel tooth are securely fastened. The machine is thrown out of gear by means of pawls at each end of the axle.

HAY WILL NOT ROLL OFF

The sideboards slope towards each other. This insures the hay being dropped on to the center of the rear end of the wagon, where it will not roll off, and where the man on the load can handle it easily.

The carrier slats, securely fastened to the carrier chain, which takes the driving strain off the ropes, are kept from catching by guides. The compressor slats, which keep the hay pressed on the carrier, are held by a brace sufficiently high above the drum to prevent choking at that point.

IMPOSSIBLE FOR RAKING CYLINDER TO WIND

The hay will not be carried around in its revolution beyond the point where it is to be delivered to the carrier. The teeth are moved by cams, being thrown out in the revolution of the cylinder in time to pick up the hay and drawn back towards the cylinder in such a manner that the hay will not fall off the teeth, yet is positively delivered to the carrier.

A VERY POPULAR LOADER

The many features of the Keystone Windrow Hay Loader herein described, and especially its light draft and simple construction make it the most popular windrow loader on the market.

Keystone Windrow, 6-foot single cylinder with forecarriage..... **\$105.00**
Keystone, 6-foot double cylinder steel without forecarriage..... **115.00**
Gearless 8-foot Loader..... **115.00**
International 6-foot Windrow, single cylinder with forecarriage..... **105.00**
International Rake-Type 8-foot Loader..... **115.00**

EXTRA CASTER WHEEL

An extra caster wheel may be had on special order and at additional cost. It is used as an additional support on rough ground. When the regular wheel is in a dead furrow or depression, the extra wheel keeps the teeth from digging into the ground, thus protecting them.

It is connected through equalizer with the main caster wheel and both are connected through a rod to raising and lowering lever. Equalizer allows the two caster wheels to balance each other on rough ground. Adjustable spring on each caster wheel rod takes up shock.

KEYSTONE TONGUE SUPPORT

For Harvesting Machinery and Disk Harrows

This Tongue Support is simple and light in weight. The springs are made of best 5/8-inch spring steel. The coils are 4 1/2 inches in diameter and have arms extending 12 inches. The wheel is 11 1/2 inches high, with 2 3/4-inch tread, thus assuring a light draft. No holes need to be bored in the tongue to fasten this support, thus allowing the tongue all its strength

Price, **\$5.00.**
Send for Special Catalogue.

See Page 23 For "Wisdom" Tomato

BINDERS

Great Names—McCORMICK and DEERING
Made Famous by World-Wide Service

Four Things
Every Successful
Grain Binder
Must Do:

- 1—Cut.
- 2—Elevate.
- 3—Bind.
- 4—Bunch the Bundles.

McCormick
Improved Binders
Do All of
Them with a
Certainty
That Pleases
Their
Owners.

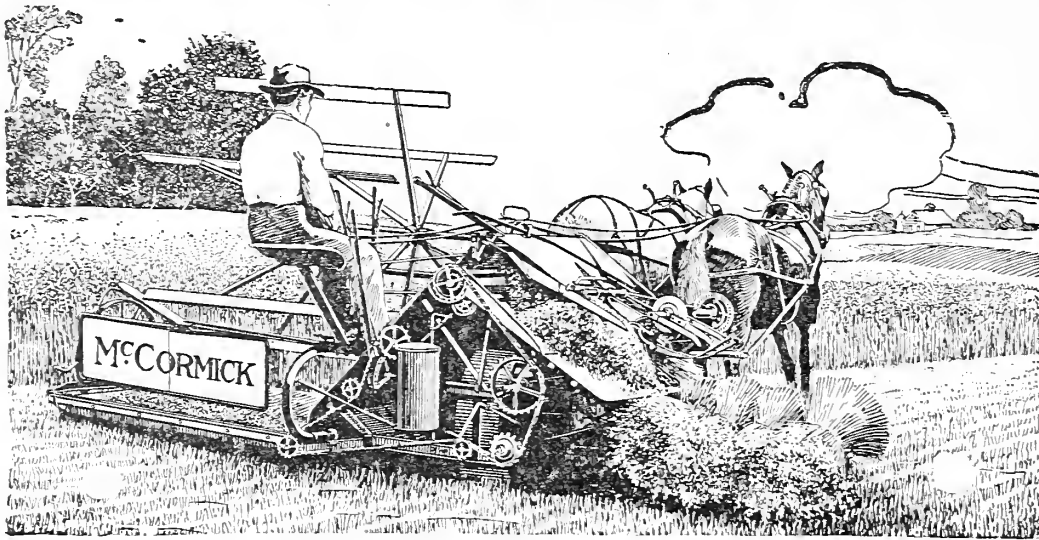

KNOWN TO
FOUR
GENERATIONS

For nearly a century the name "McCormick" has been known to men who farm along broad, progressive lines as an assurance of highest quality in farming implements.

The McCormick Improved Binder meets a wide range of conditions. The rigid frame combines strength and light weight. The binder is easy to

operate, its simple design making adjustments few and far between. It saves the grain, whether short or tall, standing or lodged. A McCormick pulls light for horses or tractor.

DEERING HARVESTING AND HAYING MACHINES Famous for Their Light Draft

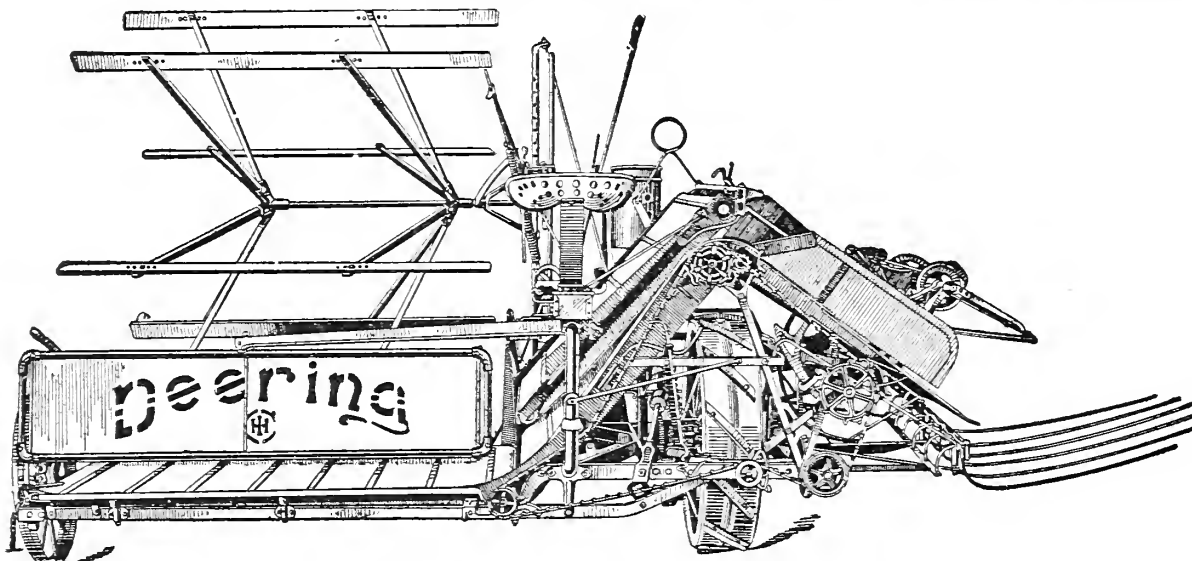

HUNDREDS OF
THOUSANDS
OF FARMERS
ALL OVER THE WORLD
BUY
DEERING BINDERS
IN PREFERENCE
TO ALL OTHER
MAKES.

OVER
TWO MILLION
HAVE BEEN
SOLD.

In every farming community all over this country you will find a large number of men who have used Deering Binders all their lives. In many cases their fathers used them, too. The use of Deering farm machines has become a sort of business policy with them, just as they deposit at a certain bank. Why? It might not be possible for them to tell you why they bought their first Deering Binder, but the first machine gave such good service that when at last they were convinced that a new binder would be more convenient or do better work because of later improvements they bought another Deering.

MOWER SMOOTH SECTION, KNIVES AND GUARDS

Made to Fit the Following Machines.	Size of Section.	Retail Price of Section.	Number of Guard.	Retail Price of Guard.	Number of Knife Head.	Retail Price of Knife Head.	Knives Complete	Pitman Boxes.	Retail Price of Pitman Boxes.
							4 1/2 Ft. 5 Ft.	Number.	
Deering.....	3x3 1/4	\$0.08	D698	\$0.40	D463	\$0.40	\$3.00 \$3.25	D711	\$0.65
Deering.....	3x3 1/4	.08	D698	.40	F123	.45	3.00 3.25	D334	1.00
Deering.....	3x3 1/8	.08	F 1 1/2	.40	F174	1.00	3.00 3.25
Deering.....	2 1/4 x 3 1/8	.08	F99 1/2	.40	F74	1.00	3.00 3.25
McCormick.....	3x3 3/16	.08	M462	.40	M139	.40	3.00 3.25	M317	.65
McCormick.....	3x3 1/16	.08	M253	.40	M139	.40	3.00 3.25
Champion.....	3x3 3/16	.08	A881	.40	A870	.40	3.00 3.25	B683 1/2	.30
Champion.....	3x3 5/16	.08	A41	.40	A415	.40	3.00 3.25
Champion.....	3x3 9/16	.08	A42	.40	A415	.40	3.00 3.25	A747	.75
Champion.....	3x3 3/16	.08	A811	.40	A415	.40	3.00 3.25
Osborne.....	3x3 3/16	.08	K514	.40	K774	.40	3.00 3.25	K826	.80
Osborne.....	3x3 High Punch	.08	K280	.40	K284	.40	3.00 3.25	K278	.65
Osborne.....	3x3 Low Punch	.08	K72	.40	K212	.40	3.00 3.25
Johnston.....	3x3 3/8	.08	1811	.40	2211	.40	3.00 3.25	2207	.65
Johnston.....	3x3 1/2	.08	77	.40	124	.40	3.00 3.25	257	1.00
Plano.....	3x3 1/2	.08	J110	.40	J94	.40	3.00 3.25	J100-J99	.65
Milwaukee.....	3x3 1/2	.08	PK5	.40	PG6	.40	3.00 3.25	PJ50	.80
Adriance Buckeye.	3x3 1/2	.08	3087	.40	557F	.45	3.00 3.25
Akron Buckeye...	3x3 3/8 Low Punch	.08	775	.40	301	1.00	3.00 3.25
Akron Buckeye...	3x3 3/8 High Punch	.08	775	.40	301	1.00	3.00 3.25
Dain.....	3x3 3/16	.08	Z5	.40	Z4	.40	3.00 3.25	Z162	.65

In ordering Knives complete, always give number of old Knife Head; also give number of cutting sections

MCCORMICK AND DEERING SIX-ROLL HUSKERS AND SHREDDERS

A McCormick Husker and Shredder—of the right fit for your farm—will insure your getting all the value that is contained in your cornfield. This value is largely represented in the stalks, husks and leaves. Shredded by a McCormick, these make prime fodder with high feeding value.

McCormick Huskers and Shredders do effective work under a wide range of conditions. The husking rolls have ample capacity for both large and small ears, husking them all clean, and the little corn that is shelled is saved. The shredder head is so constructed that the fodder is left in the best condition, palatable and nutritious.

McCormick Huskers and Shredders are built in 4, 6, 8 and 10-roll sizes. Whatever your crop calls for there is a machine exactly suited to take care of your needs swiftly, economically and efficiently.

There are many unusually fine features about these machines that impress you with their practical value upon a close inspection. Come in and look the McCormick over with your critical eye. You'll find there's money in owning one.

When desired a cutter head can be furnished for this machine to replace the shredder head, which cuts the dry fodder in ensilage lengths and can be blown in the silo while husking.

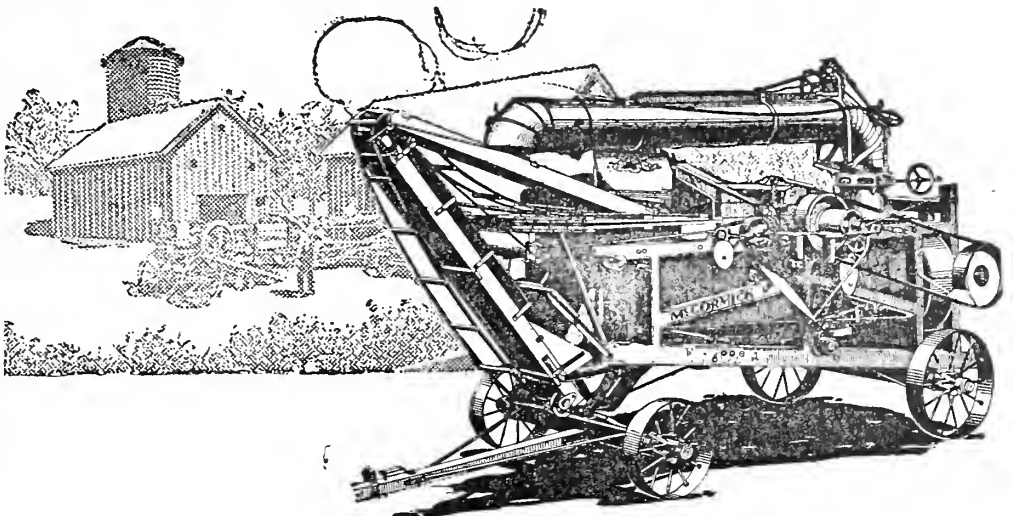

MCCORMICK AND DEERING CORN BINDERS

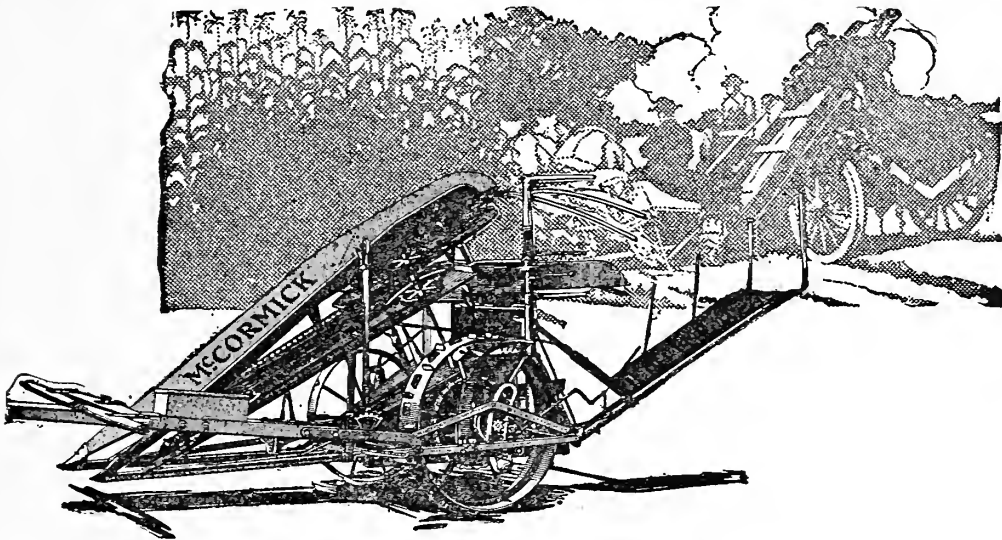

A McCormick Corn Binder goes into a field in the morning and cuts up to eight acres by nightfall, leaving the bundles firmly bound and laid off the ground without breaking off the ears. One man with a McCormick Corn Binder will keep two or three men busy shocking.

With the durability and convenience of the McCormick you will be money ahead on the whole job of harvesting your corn, whether it is cut for ensilage or shocked in the field.

GET YOUR OWN THRESHING DONE EARLY, THEN PAY FOR YOUR OUTFIT BY THRESHING FOR NEIGHBORS

How many seasons can you remember when you have been obliged to wait for weeks to get your threshing done? You know that your neighbors suffer from the same delays. If you own your threshing outfit, you can first thresh for yourself, get your own crop out of the way and be preparing your fields for a new crop. Then you can thresh for your neighbors.

JUST RIGHT FOR NEIGHBORHOOD THRESHING

The International Thresher is made in two sizes, 22x38 and 28x46. Just right for threshing the crop on medium-sized grain farms, doing the work quickly and economically, and yet not so large that they cannot be readily transported.

ANOTHER USE FOR YOUR TRACTOR

Almost every farmer owns a tractor nowadays. At certain times of the year the tractor is idle and he needs additional work to make it a better paying investment. If he owns an International Thresher he can earn more money with both the thresher and the tractor.

THRESHER WELL BUILT

In the International Thresher is incorporated the experience of more than three-quarters of a century in building grain machinery. The men who designed and built it are men of long experience, not only as manufacturers, but as threshermen. They know the needs of the farmer and have carefully considered them. Every grain-saving feature, every convenience and every device to insure long life has been added to the machine.

YOU CAN MAKE MORE MONEY

The farmer who makes the most money nowadays is the one who gets some extra service out of his machine besides that on his own farm. A thresher is one of the best money-making machines you can own, because it is a long-lived machine, requires few repairs and earns a generous profit for its owner.

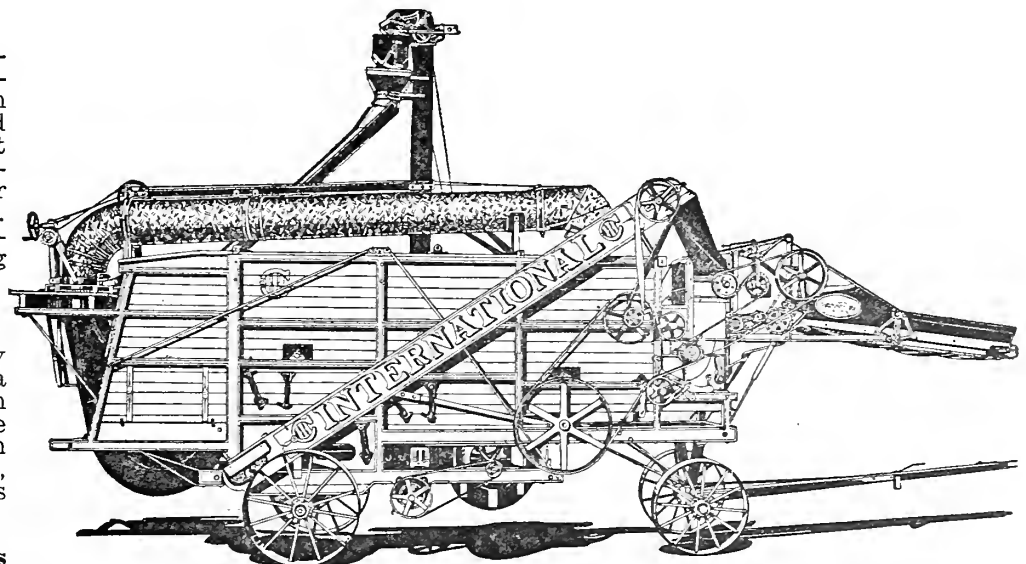

Send for Special Catalogue and Prices

"IRON AGE" (IMPROVED ROBBINS) POTATO PLANTER

No. 40LE POTATO PLANTER WITH NEW ADJUSTABLE ELEVATOR WHEEL

This planter is known as the 100 per cent planter because it puts one seed piece, and only one, in every hill—no misses or doubles. You do not plow, harrow, plant, spray, cultivate and dig over missed spaces which bring you no profits. It also avoids the waste of fertilizer and spray material on unplanted spaces.

The planter is constructed almost entirely of steel. This gives decided advantages of strength, lightness and compactness over planters with cast-iron or wood frames. It is perfectly balanced, with less weight for the horses to pull. There are no heavy, bulky castings to replace because of breakage. The steel seed box is lighter, more durable than wood and holds more seed than a wooden box of the same size.

The construction is simple, allowing you to get at all parts easily.

We are now equipping this planter with our new patented adjustable feed wheel. This wheel is adjustable to an exact variation giving all sizes between those of the extra plates formerly used. Sometimes one plate was a little too large and the other a little too small, but the new feature gives any adjustment wanted.

With this new plate there is no trouble of losing or mislaying the extra plates formerly supplied. It also reduces the work of the boy on the rear.

Side Dressing, Ridging, Corn, Bean and Pea Attachments can be supplied. With these attachments tractors can find use for the machine throughout the season.

Making up rows, opening furrows and covering them can be done with the regular machine.

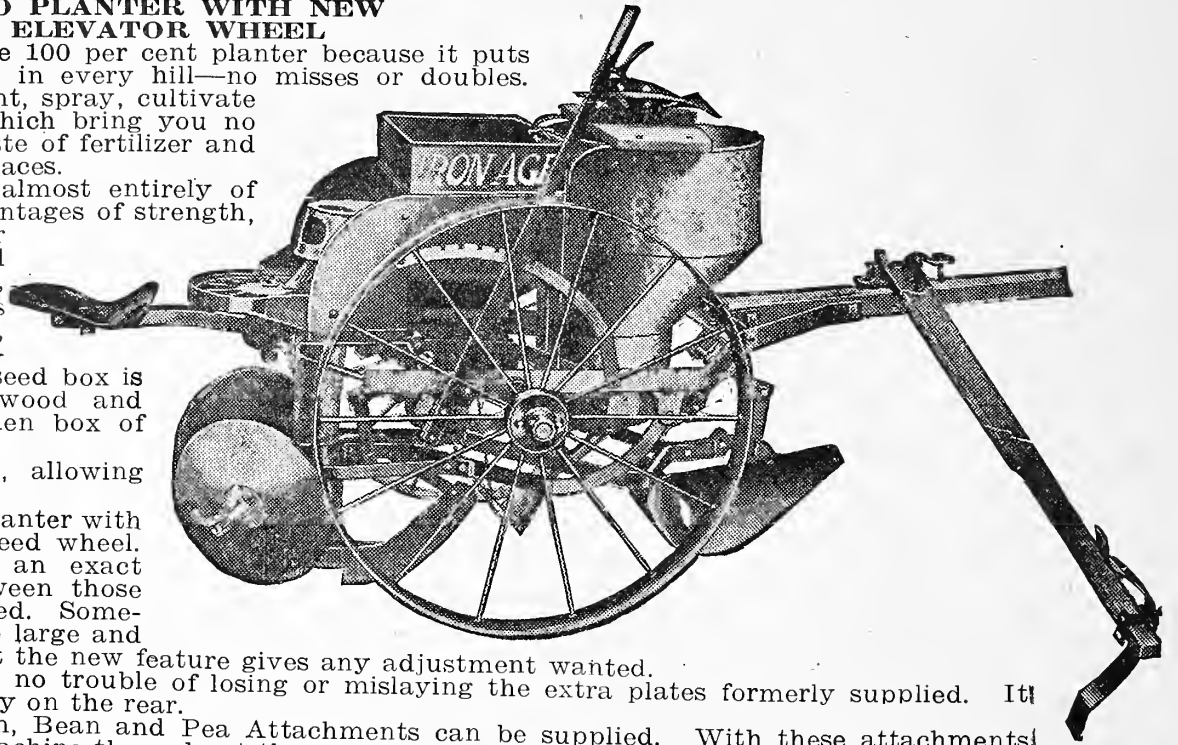

C B & Q No. 2 CORN PLANTER

You Can Use Edge-Drop, Flat-Drop and Full-Hill-Drop Plates in the Same Hopper Without Any Change in the Mechanism

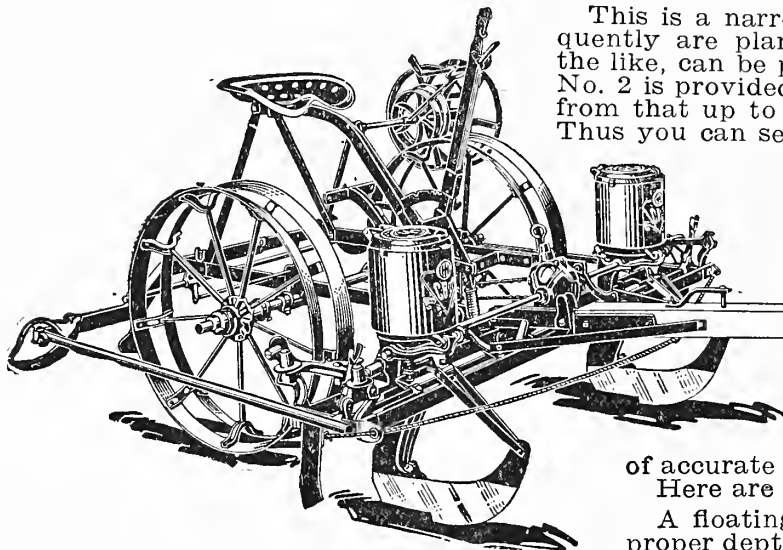

This is a narrow planter for beans, peas, beets and other crops that frequently are planted in rows close together. Ensilage corn, popcorn, and the like, can be planted in narrow rows where the soil is fertile. C B & Q No. 2 is provided with adjustments for planting in rows 28 inches apart and from that up to 44 inches apart, with adjustments between every 2 inches. Thus you can see that it can be adapted to a greater variety of crops.

In the bean section of this country C B & Q No. 2 is used largely with power drop attachment for planting full hills of beans or peas every 14 inches in rows 28 inches apart. This is only one of the great many combinations of hill distances that can be secured by changing sprockets and seed plates. The power drop attachment, which replaces check wire, is an extra, purchased at slight additional cost. It is extremely simple and fits any C B & Q planter. It can be put on at any time. C B & Q No. 2 is provided with side bar marker of the adjustable type.

The merit of this corn planter is that it pleases experienced farmers who are satisfied with nothing short of accurate planting at even depth.

Here are a few of its convenient features:

A floating runner frame that puts the seed in to the ground at the proper depth. Force feed valves prevent stringing and place the kernels in the bottom of the furrow. Can be equipped with seed plates to plant any kind of seed from Kaffir corn to the biggest beans. There are six types of C B & Q Planters—one to meet every planting requirement.

One of the strongest features of the C B & Q Planter is the combined variable drop and clutch. The clutch is built into the dropping mechanism in a way that is simple and effective. By means of the variable drop, 2, 3 or 4 kernels can be planted in each hill, and the change can be made from the seat without stopping the team. The clutch is positive and accurate. This is one of the strongest features on the C B & Q Corn Planter.

Price, with 80 rods wire, \$72.50. Fertilizer Attachment extra, \$22.00.

SEED PLATES FOR C B & Q PLANTER

Three types of plates, the edge drop, the flat drop and the full-hill drop, can be had for the C B & Q Planter. There is a large assortment of each one of the three types of plates to fit various sizes and shapes of kernels.

Plates can also be furnished for the following grains: Indian corn of several varieties and sizes, popcorn, sweet corn, milo maize, Kaffir corn, sorghum cane, beets, peas, cow peas and beans of various sizes.

PLANT YOUR CORN RIGHT

When the kernels of corn are planted at just the right depth in the soil for proper germination and growth, the bigger end of your work in getting a good crop is done.

Much depends upon the planter—the rest upon your knowledge of how to run it and upon the quality of the seed.

The C B & Q Corn Planter will plant the corn as you want it planted because it is adjustable to your particular planting conditions. The tongue and runner frame are adjustable to suit the team used on the planter. The adjustment accomplishes two things. First, it keeps the seed plates level so that they operate in harmony and exactly on time with the valves in the boots, and secondly, the corn will be checked evenly regardless of the speed of the team or its height.

Make Money By Planting The "Wisdom" Tomato (See Page 23)

GENUINE No. 2 HAINES MARKERS

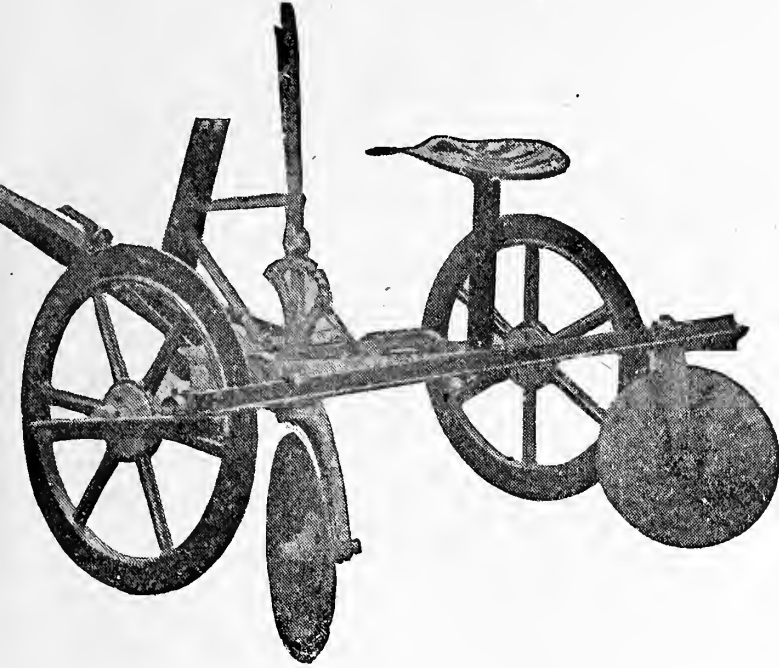

The Genuine No. 2 Haines Marker has been greatly improved for this season. Among the changes made is the disc hanger being in two parts. When the bearing becomes worn it may be replaced at small cost. The top of hanger has teeth cast all around the top, so that any angle may be had. The frame of the marker has improvements and has been strengthened. The lever and quadrant have been re-designed.

The marker is made in two sizes, for two rows and four rows. All sizes have self-oiling disc bearings.

All these improvements have been added to make the marker thoroughly up-to-date. Look the Genuine No. 2 Haines Marker over before you buy and you will make no mistake.

The marker can be regulated to open rows at any depth required by the use of the lever in front of the operator, and may be adjusted while the machine is in motion.

The marker is of light draft and easily controlled by a light boy, as it is not necessary for operator to dismount at ends of furrows to lift one pound.

The marker is a perfect covering or listing machine, covering one or more rows as may be required, and is under perfect control of operator by use of lever that may be adjusted while the machine is in motion.

The marker is very quickly changed from marking to covering; it is only necessary to loosen two nuts and move disc along to the required place and adjust. The machine is graduated with the different distances that may be plainly seen by the operator.

The marker is strongly built and equipped with marking-pole, double trees and neck-yoke, and the machine is under the control of the operator, who, by lowering or raising lever can adjust depth of furrows and raise disc from ground at ends of row while turning without dismounting. Price, \$40.00.

We also have the exclusive agency for the IMPROVED GILTZ MARKER.

The GILTZ is a well-known marker throughout Anne Arundel County, having been in use many years. This marker has been greatly improved by Mr. Giltz, the patentee, with the following features: First he has solved the problem of an absolutely dust-proof wheel hub boxing. The wheels are higher than any other marker made and are adjustable from two to six feet for covering and opening the furrows, and is elevated to a sufficient height to prevent main frame from dragging. The angle irons are made of heavy Carnegie steel, and will positively not bend. Be sure to see this marker before purchasing. Price, \$75.00.

THE HAINES FERTILIZER DISTRIBUTOR

Will Handle All Grades of Commercial Fertilizer, Lime and Ashes, in Rows of All Widths

The Haines Universal Distributors are made in several sizes to meet the various requirements of the planters and farmers.

It can be used as a broad caster for lime or fertilizer. It is easy to load and brings the distributor near the ground, only 11 inches for materials to fall, and for that reason the light materials are less liable to be carried away by the wind. Any quantity per acre may be sown by these machines by simply moving one lever to the adjustment required.

No gears of any kind, no chains, no sprocket wheels, no belts and no springs—fewer parts than any other machine. A positive force feed, strong enough to handle the materials being used without caking in the hoppers, and at the same time giving regular discharge of materials.

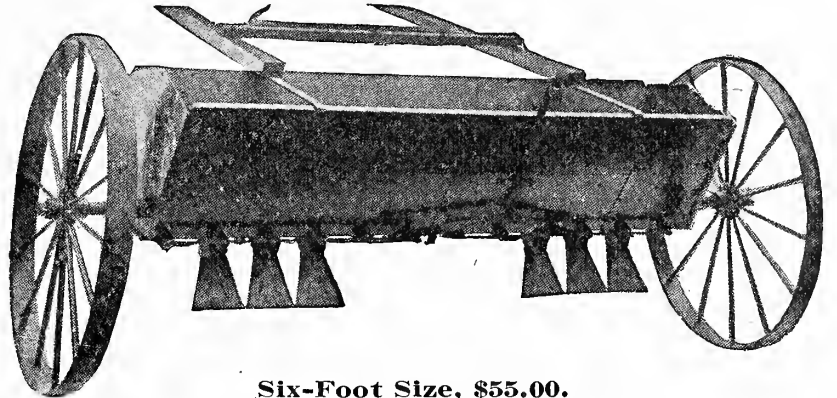

**Six-Foot Size, \$55.00.
Eight-Foot Size, \$60.00.**

NEW FEATURES

The new features of the Haines Universal Distributors have a wide variety of changes for distribution in rows. This goes with the Haines Distributor without additional cost. In the change from broadcast to rows the only thing to do is to stop off the holes not wanted and attach the spreaders to fit the rows and the row combination is completed. The quantity sown to the acre is regulated by the lever.

The farther the lever is thrown over, the larger the quantity sowed to the acre.

The Haines Universal Distributors are low down, easy to load and easy to operate. Will sow materials in orchard work close to trees where other sowers cannot get on account of large wheels and other attachments.

The Haines Universal Distributors have fewer parts than any sower made; therefore making less expense for repairs. Very few castings. Heavy steel bottoms of No. 10 gauge steel. In other machines will be found as light as 24-gauge steel, which is easily bent and worn out.

The Haines Universal Distributor has an axle in two parts with good centre bearing, making it easy to turn at ends of rows, and makes a distributor of strong construction, eliminating the necessity of using a truss for centre support, as the agitators are parallel to the bottom plate at all times, making an even distribution.

The Haines Universal Distributors have been put to the most severe tests—fifty pounds of nitrate of soda to the acre, while 3,000 pounds of fertilizer have been sown with the same machine.

The Haines Universal Distributor has met with considerable favor among the truckers of Anne Arundel and Baltimore Counties. It has been found especially useful for top dressing different crops and will sow any quantity of fertilizer up to 3,000 lbs. to the acre. The following users will be glad to furnish information as to their good qualities.

J. Rufus Benson, Lansdowne, Md.
I. L. Shipley & Bro., Harmans, Md.
B. H. Smith, Severn, Md.

J. F. Shipley, Brooklyn, Md.
Samuel Clark & Sons, Harmans, Md.

Lay off the rows and plant the "Wisdom" Tomato (See page 23)

CHAMPION STEEL FIELD ROLLERS

In offering our Champion Steam Field Roller we do so believing it to be the best roller of its kind on the market. We call particular attention to the patent pressed steel head, which keeps the earth from clogging in the shells as in an open-head roller; also to the removable chilled bushing, which is bolted fast to the head, and which is a valuable feature, as they can be readily replaced by any one at a trifling expense and saves the trouble and cost of sending the roller to the machine shop when the bearings are worn out. Diameter is 26 inches. Wood frame.

No. 105—Size, 8 feet, 2 sections; weight 600 lbs. Price, \$42.50.

No. 106—Size, 8 feet, 3 sections; weight 630 lbs. Price, \$45.00.
Prices include double trees and neck yoke.

BUCK'S No. 105½ LAND ROLLER

The description of No. 105½ is identically the same as Roller No. 105, excepting that it has a steel frame instead of wood frame.

This roller has our angle steel frame, which makes it an all-steel roller, except the tongue. In this respect it may be said that it is a trifle more durable than the wood frame, as naturally the steel will outlast the wood. There is little choice between them. It is an excellent implement in every respect. Rollers Nos. 102½ and 107½ are of the same construction. Diameters, rolling surface and prices will be furnished on application. Material and workmanship are of the highest grade. With proper care it ought to last a lifetime, as there is nothing to wear out but the wood journals, and these can be replaced at a trifling cost. 8-foot, 2-section, \$42.50; 8-foot, 3-section, \$45.00.



WHY A SOIL PULVERIZER

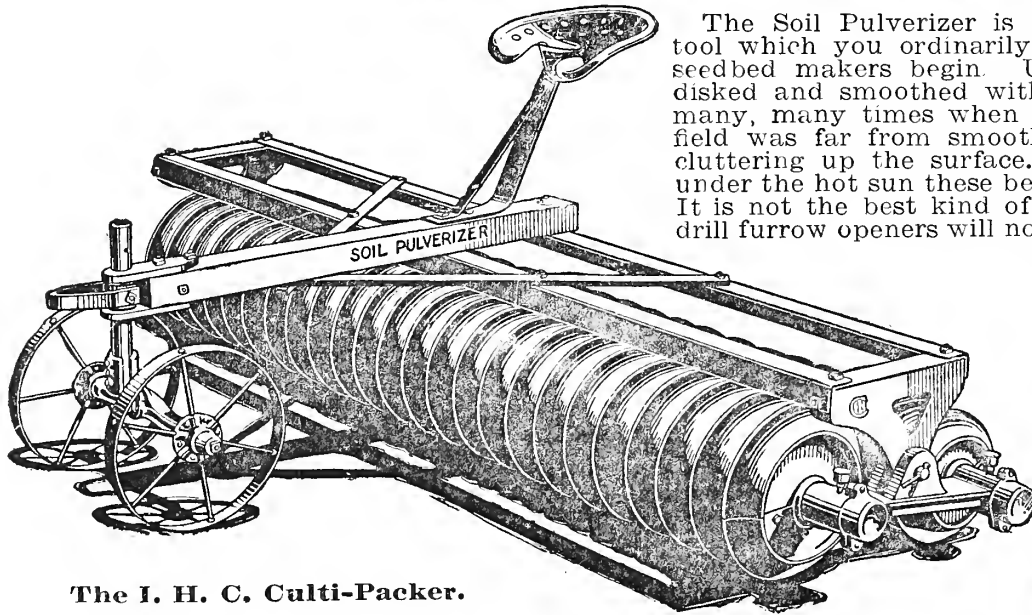

The I. H. C. Culti-Packer.

The Soil Pulverizer is not recommended to replace any tillage tool which you ordinarily use. It simply finishes what the other seedbed makers begin. Under the old way, a field was plowed, disked and smoothed with a peg-tooth harrow—but you know of many, many times when after those operations were complete the field was far from smooth. There were great lumps of dirt still cluttering up the surface. Hard clods were scattered about, and under the hot sun these became solid and utterly devoid of moisture. It is not the best kind of a seedbed to plant grain in, because the drill furrow openers will not penetrate evenly—some seed is scattered about on the surface to be eaten by the birds and the resulting stand is considerably under normal.

Made in all sizes. 98 inches long, front 15-inch diameter, rear 12-inch diameter, \$95.00.

WATER BALLAST LAWN ROLLER



HAND ROLLERS

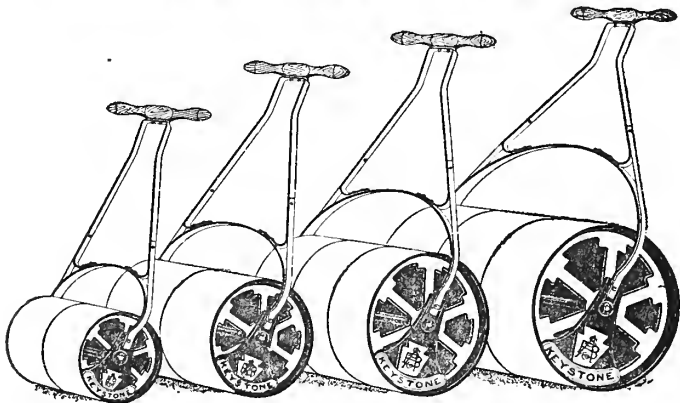

Our Hand Rollers are smooth on face and aluminum finish; outer edges rounded. No wet grass or dirt will cling to them. The handles are counterbalanced, which keeps them always in right position. Removable roller bearings, which can be quickly and cheaply replaced. Weights precisely as listed.

Number	Number Section	Width Face	Diameter Section	Total Length	Weight	Price
4 or 504	2	10-in.	20-in.	20-in.	250 lbs.	\$22.00
6 or 507	2	10-in.	20-in.	24-in.	300 lbs.	27.00
9 or 509	2	10-in.	24-in.	20-in.	400 lbs.	35.00

filled with water to any desired weight. It can thus be regulated to suit soft turf, firm lawns or driveway, tennis court, etc. It can be emptied for storing away, making it light and easy to handle. The drum is high carbon steel with all seams electric welded. Edges are rounded back to prevent cutting of lawns, courts, etc.

Prices Water Ballast Rollers

No.	Dia. in.	Length in.	Empty Weight	Weight		Price List
				Filled with Water	Filled with Sand	
601	14	24	60	250	400	\$18.50
602	18	24	75	330	475	22.25
603	24	24	100	440	630	25.75
604	24	32	115	590	850	28.00

ABC "ALCO" WASHER for ELECTRIC or GASOLINE ENGINE POWER

THE ABC ALCO ELECTRIC is the outstanding washer in its field. For more than ten years it has served the American housewife—has lifted her burden of washday drudgery. And the first ones manufactured are still giving more than satisfactory service, week in and week out.

The feature that has contributed most to its popularity and made it the unquestioned leader, is the unique underneath drive. All mechanism is under the tub, surrounded by the rigid frame of heavy steel, entirely out of range of the person or clothes of the operator. This "safety first" feature appeals instantly to women.

Whether of double or single type, the "Also Electric" is honestly built throughout of the best materials obtainable. The power motor (50% over-size) is especially designed for this machine. It furnishes ample power to operate both washer and wringer at the same time.

Sturdy and compact, the ABC "Alco Electric" is a complete, smooth, quiet-running washing machine. The tub is built of the finest selected Florida Cypress, much larger, heavier and therefore more lasting than most other makes. The finish is exceptionally attractive—the tub is beautifully varnished and the metal parts are finished in aluminum.

The ABC "Alco Electric" is manufactured and guaranteed by one of the oldest and largest exclusive power washing machine manufacturers in the world. It is produced on a **quantity plus quality** basis which makes the Alco Electric the best "dollar-for-dollar" value in the country.

You will be more than satisfied with your power washer if it is an "Alco Electric." It does its work quickly—an hour or two suffices for the largest family washing. It is economical—it saves clothes and money. And the crowning glory of the ABC "Alco Electric" is that **it washes clean.**

No. 51E—ABC "Alco" Electric Single Tub Average Family Size Capacity—6 sheets or equivalent.

Full swinging wringer—Works in any position. Operates on the motor power. Can be run while washer is working, or separately.

Motor—Standard water-proof ¼ H.P. motor—any voltage or frequency, complete with 10-foot cord and plug.

Height—From floor to top of tub, 34 inches.

Floor Space—Frame, length 29 inches; width 26 inches. Folding bench when extended for use adds 15 inches to length.

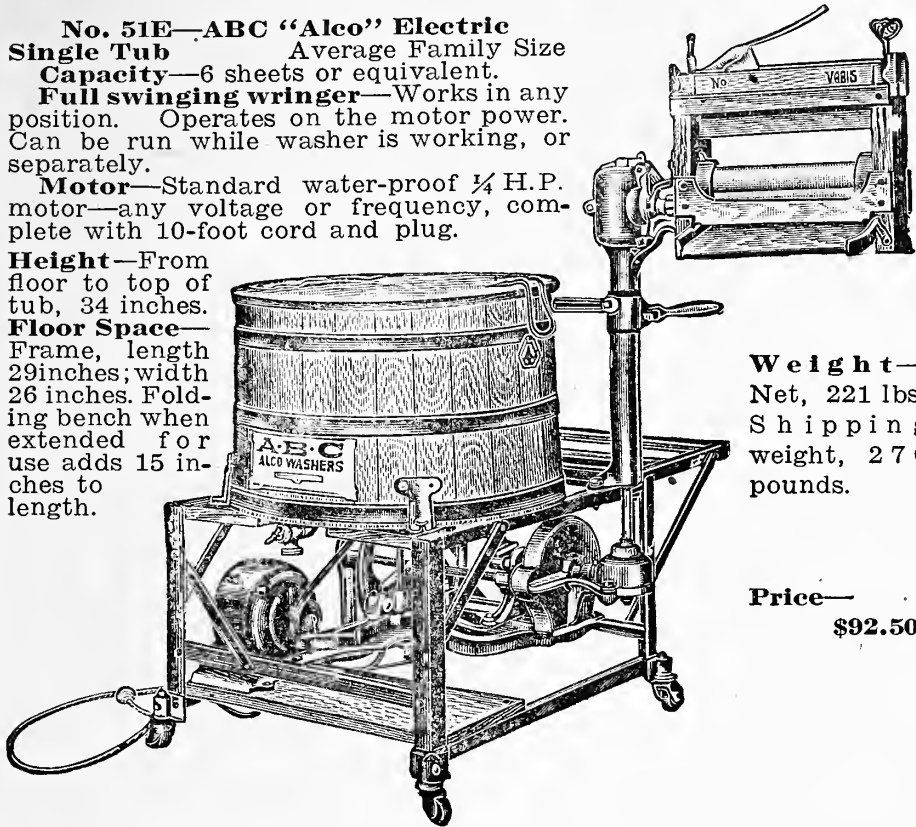

Weight—Net, 221 lbs. Shipping weight, 276 pounds.

Price—\$92.50.

No. 52—ABC "Alco" Twin Power—Double Tub

Belt Drive for Gasoline Engine

This washer is of the same capacity and construction as the No. 52E, except that there is no motor.

Power—Regularly equipped with 12-inch pulley for belt drive. Speed of main drive shaft required, 175 revolutions per minute.

Height—From floor to top of tub, 34 inches. **Floor space**—Frame, length 43 inches; width 27½ inches. Folding bench when extended for use adds 15 inches to width.

Weight—Net, 274 pounds. Shipping weight, 340 pounds.

Price—\$85.00.

Everybody's Rotary Washing Machine



The Best Thing Yet

Well constructed, of good material. Will wash the most delicate fabric as well as the regular weekly wash. A boon to the housewife. Easy to operate, nothing to get out of order. Price.....\$15.00

Electric Welded Wire Hoops. Virginia White Cedar Tub. Roller Bearings.

This is the lightest running and easiest working Washing Machine made. Roller bearings; no friction. Works in both directions. Very simple; nothing to get out of order. Nicely corrugated on sides and bottom. Hoops are galvanized wire and are welded by electricity; these are much stronger than the old-style flat hoops, and CANNOT DROP OFF, being sunk in grooves. Our special price.....\$15.00

Relief Clothes Wringers

- No. 330—Small Family—Rolls,** 10x1¾ ins.\$5.50
- No. 332—Large Family—Rolls,** 12x1¾ ins. 6.50
- No. 330—Rolls, 10 ins., each**..... 2.00
- No. 332—Rolls, 12 ins., each**..... 2.25

No. 52E—ABC "Alco" Twin Electric—Double Tub For Large or Heavy Washes

Capacity—6 sheets or equivalent in each tub. Total capacity 12 sheets or equivalent.

Both tubs equipped with dolly. Actuated by separate starting levers. Both tubs can be run at same time or either one alone.

Full swinging wringer—Works in any position. Operates on motor power. Can be run while either or both tubs are operating, or separately.

Motor—Standard water-proof ¼ H.P. motor. Any voltage or frequency. Complete with 10 foot cord and plug.

Height—From floor to top of tub, 34 inches.

Floor space—Frame, length 43 inches; width 26 inches. Folding bench when extended for use, adds 15 inches to width.

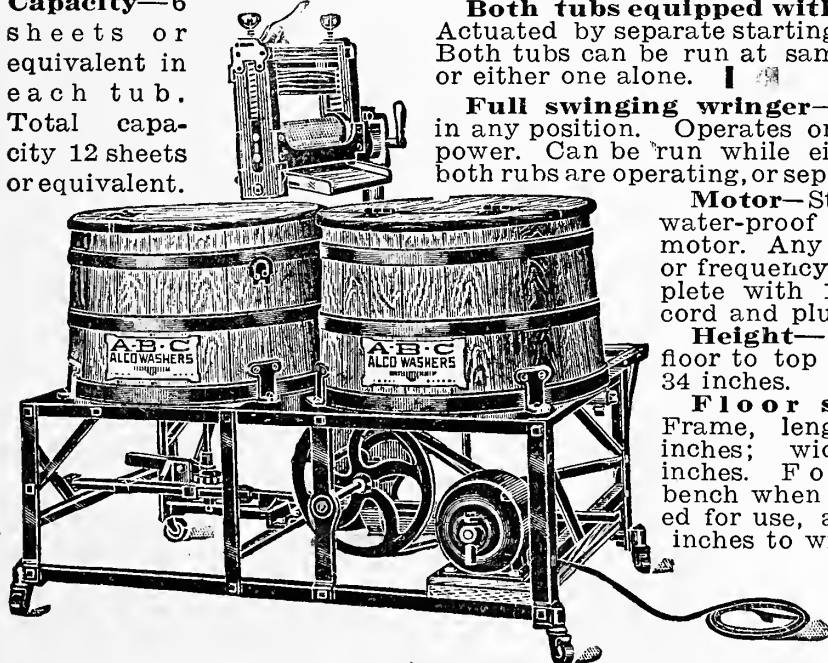

Price \$115.

Weight—Net 311 pounds. Shipping weight, 405 pounds.

Gasoline Engine Power Washers

No. 51—ABC "Alco" Power—Single Tub Belt Drive for Gasoline Engine. This washer is of the same capacity and construction as the No. 51E, except that the drive shaft is extended and equipped with flat faced pulley.

Power—Regularly equipped with 12-inch pulley for belt drive. Speed of main drive shaft required, 175 revolutions per minute.

Height—From floor to top of tub, 34 inches.

Floor space—Frame, length 29 inches; width 27½ inches.

Folding bench when extended for use adds 15 inches to length. **Weight**—Net, 187 lbs. Shipping weight, 246 lbs. **Price**—\$62.50.

THE FULLER & JOHNSON STEEL FRAME BEMIS TRANSPLANTER

The machine can be thrown in and out of gear, greatly increasing its life. A ratchet clutch throws the mechanism out of gear when backing, saving water and avoiding breakage.

A strainer in the barrel prevents the valve from becoming clogged and the obstruction of free flow of water.

When in operation the front truck can be locked so machine will run straight on the row. This does away with the wobbling side motion experienced where swivel or castor rollers are used.

The wheels are our own patent, 36 inches high, very strong, made with replaceable boxings and spokes, which can be easily replaced by any blacksmith in case of breakage. Wide tires reduce draft.

The droppers do not get off at the end of the row.

The tongue is joined like a wagon, so there is no weight on the necks of the horses.

The entire machine is simple and very strong so that with proper care it will last for years.

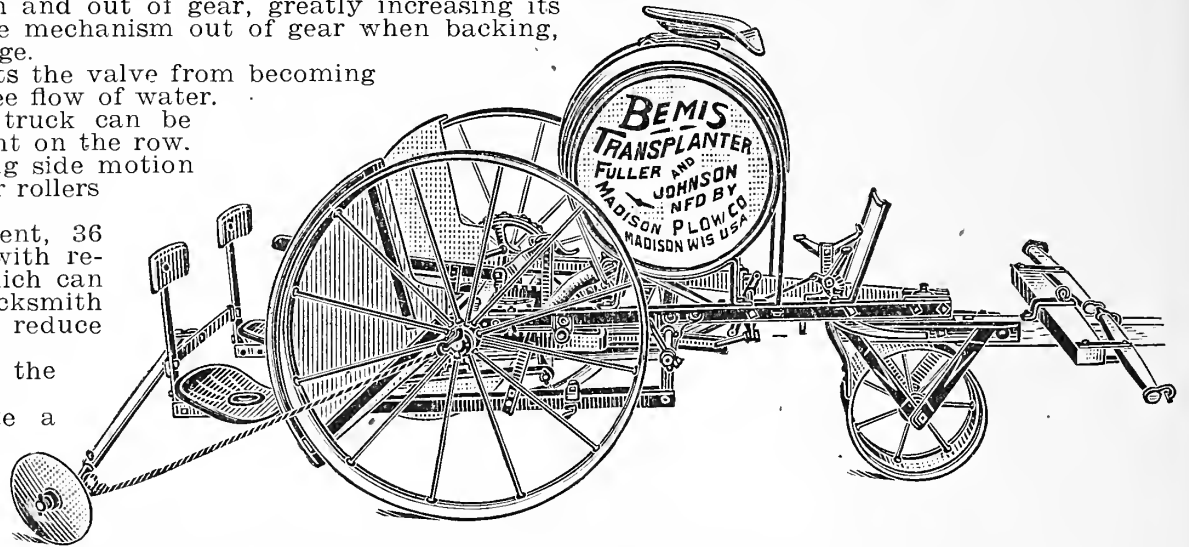

The grower is independent of labor and free from a lame back.

SEND FOR SPECIAL CATALOGUE

This machine has revolutionized tobacco setting, as there are now practically no large tobacco growers in the United States who set their plants by hand. It is also extensively used by market gardeners, nurserymen, etc. The supply of water can be regulated as conditions require.

We make a special potato planting attachment, and an extra-large shoe for setting nursery stock. We also make an attachment for sowing fertilizer in the trench with the plants and check-rower attachment for use where cross-cultivation is desired. For planting on ridges we can furnish the machine with two-wheel front truck to straddle the ridge and adjustable axles to raise the machine to conform to the height of the ridge. These axles provide for a variation of 5 inches in height of the machine.

The essential features of a transplanting machine, including the floating shoe, pressure plates, etc., are covered by our patents, and the working parts of our machine are so perfect that it is acknowledged by growers in all sections of this country, and in many foreign countries, that the Fuller & Johnson Bemis Transplanter is the best. The plants can be set when they are ready, no matter how dry the ground. In hand setting plants are often set when too small or when too large, as they must be set when the weather is suitable. As there need be no delay in planting on account of dry weather, the ground can be carefully prepared just before planting so as to kill all the weeds. The planting is equal to once cultivating, as the machine stirs the ground in the row, killing the weeds. The roots are not doubled up, and the plants start better. Even pressure is obtained on uneven ground by means of the floating shoe and pressure plates, which are independent of the shoe and of each other. This is the only successful device for this purpose used on a transplanter, and is covered by our patents. Spring pressure can also be applied from the lifting lever if desired. The earth is pressed about the plants by means of the hardened polished steel plates. The shoe is also made of hardened steel and finely polished. Price, \$110.00.

THE TIGER PLANT SETTER

The Tiger Planter was designed primarily for the purpose of enabling the farmer to transplant, irrespective of seasonable conditions. At the same time, it was constructed so as to make the planting more rapid and accurate.

As shown in the illustration, the machine consists of a reservoir for water mounted upon a strong metal frame. The driver's seat is on top of this reservoir, while the planter's seats are low down and at the extreme rear.

The heavy castor wheels in front presses the ground so that a better defined trench can be opened by the runner which follows it.

At the spot where the plant is placed a certain quantity of water is omitted, and the earth gently pressed around the shoot by pressure plates or press wheels. This water is discharged at intervals regulated by the sprocket wheels of the trip shaft.

The Important Feature of the Transplanter is the Valve Mechanism. Examine the Tiger.

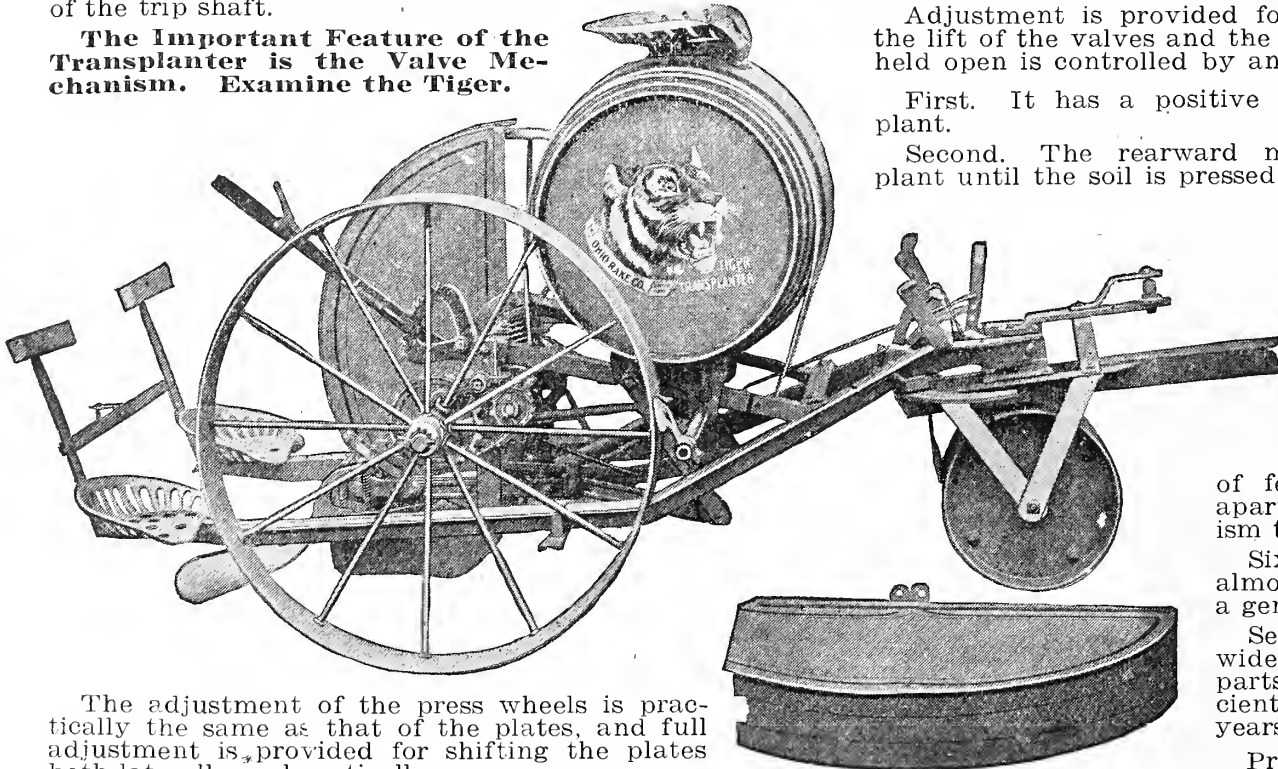

Adjustment is provided for increasing or decreasing the lift of the valves and the length of time the valve is held open is controlled by an adjustable valve bar.

First. It has a positive force to gauge setting of plant.

Second. The rearward movement of hand holds plant until the soil is pressed firmly about the plant.

Third. Flow of water is under perfect control and can be regulated to deposit as small a quantity as desired or one pint to each plant.

Fourth. Valve is non-corrosive, has a flat rubber stopper resting on a brass seat, which is faced perfectly level.

Fifth. Valve is composed of few parts, is easily taken apart, no complicated mechanism to cause trouble.

Sixth. Swing of valve is almost noiseless, returns with a gentle easy movement.

Seventh. Valve pivots on a wide bearing, and all wearing parts are provided with sufficient surface to insure many years of service.

Price, \$100.00.

The adjustment of the press wheels is practically the same as that of the plates, and full adjustment is provided for shifting the plates both laterally and vertically.

The introduction of spring pressure directly on the plates or wheels, together with the heavier spring pressure on the runner, forms a combination eminently suited to the conditions under which the work of transplanting must be done.

Be sure the tomato plants are the "Wisdom" (See page 23)

SAW TABLES AND SAWS

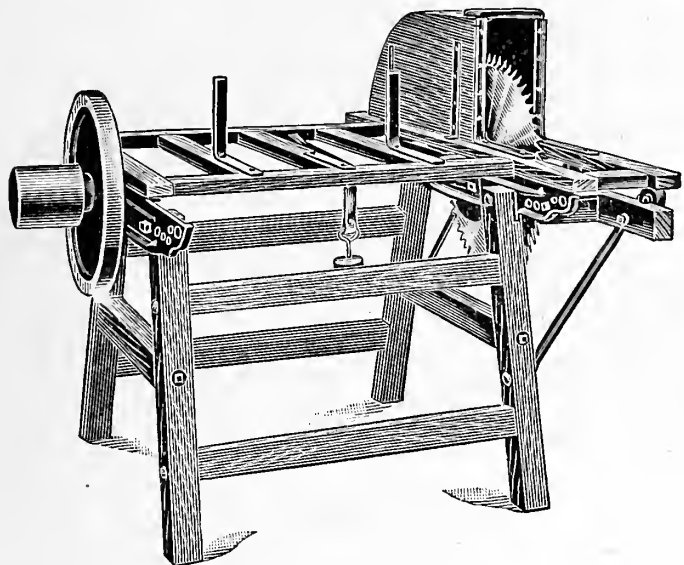

AMERICAN SLIDE-TABLE SAW

A splendid machine. The frame is constructed of 4-inch hardwood mortised and bolted. The arbor is 1½-inch cold rolled steel. The distance from fly-wheel to saw is 3 feet 1½ inches. The table operates on rollers, which run on a grooved and smooth track, and a cast guide keeps it in position. An iron counterbalance, not shown in illustration, is furnished. This is attached by a rope to the table, and brings it back to position when the cut is made. The machine is furnished with a guard, as shown in illustration. The saw blade is the very best obtainable, and will be replaced free if found defective. Left-handed machines, as shown in illustration, furnished, unless otherwise ordered. Weight, 400 pounds. Speed, 1,000 revolutions per minute when a 24-inch saw is used.

Prices:

With 26-inch saw.....\$40.00
 With 28-inch saw..... 42.00
 With 30-inch saw..... 44.00

WOOD AND POLE SAWS

The frames are made of selected seasoned hardwood, accurately mortised and tenoned and securely bolted together by steel rods alongside the girts and passing through from one side of the frame to the other. They are strongly braced in every direction and handsomely painted with two coats of brilliant red paint on the wood and black on the iron parts.

The mandrels are polished steel, perfectly true and run in heavy babbitted boxes. On the Nos. 3, 4 and 5 these boxes are united by a heavy cast-iron yoke, insuring perfect alignment and cool bearings

The balance wheels are accurately balanced, insuring a quiet, steady-running, durable machine. They weigh from 75 to 80 pounds, which is best for general work, but we can supply heavier balance wheels when desired at small extra cost.

Each machine is fitted with a strong, adjustable saw guard that will admit any size saw from 20 to 30 inches.

No. 4 has extension table for cutting poles of 4 or 8-foot cord wood. By changing the iron guard to the opposite end of the tilting table this machine can be set up exactly as No. 3.

Prices:

24-inch blade.....\$41.00
 26-inch blade..... 42.00
 28-inch-blade..... 43.50

PORTABLE AND STATIONARY SAW OUTFITS

—Send for special catalogue.

Believing that a cheaply built wood saw is dear and a bad investment at any price, we have always sold high-grade machines only, and, value compared with cost, we are giving greater value than is possible in the cheaply built machines.

The table is so arranged as to extend nearly five feet beyond the saw blade. It makes a highly satisfactory combined pole and cordwood saw, because the length

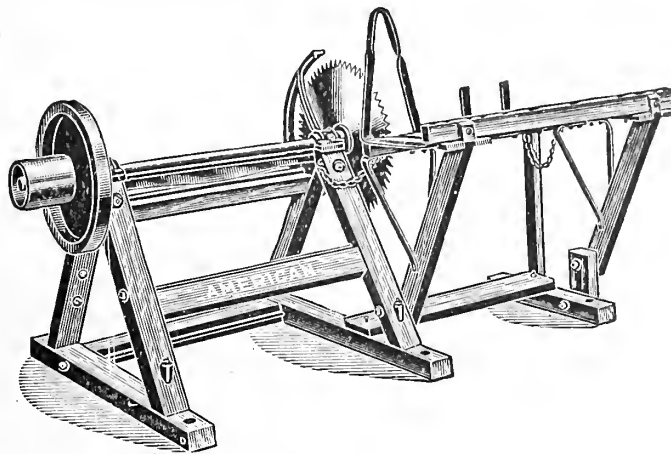

and arrangement of the table is, such as to enable the operator to handle long poles about as easily and rapidly as cord wood. To facilitate handling a roller is placed at one end of the table. Weight, 354 pounds.

Prices:

Without saw.....\$33.50
 With 24-inch saw..... 41.00
 With 26-inch saw..... 42.00
 With 28-inch saw..... 43.50
 With 30-inch saw..... 45.00

We carry a full line of CIRCULAR SAWS:

22-inch, No. 12 gauge.....\$ 7.00
 24-inch, No. 11 gauge..... 8.00
 26-inch, No. 11 gauge..... 10.00
 28-inch, No. 10 gauge..... 11.00
 30-inch, No. 10 gauge..... 12.25

SAW MANDRELS—Write for special circular of sizes and prices.

No. 3 Cord Wood Saw Right Hand

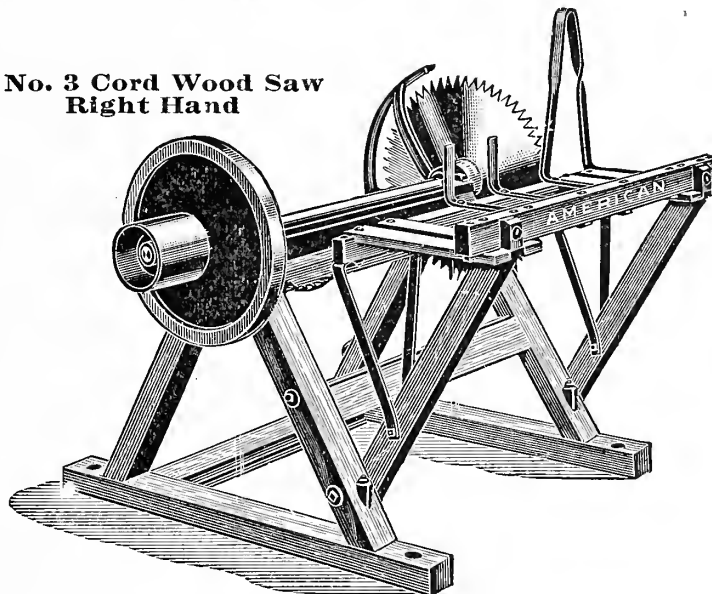

Specifications.

Mandrel, 1½ in. diameter, 52 in. long.
 Distance saw to balance wheel, 42 in.
 Mandrel pulley, 6x6 in.; speed, 1,200 to 1,800, depending on size saw.
 Will take saws 20 in. to 30 in. with 1¼ in. hole.
 Shipping weights, No. 3, 300 lbs.; No. 4, 330 lbs.; No. 5, 385 lbs.; No. 6, 335 lbs.
 These machines are regularly shipped knocked down. Shipped set up if so ordered, without extra charge.

CORD WOOD SAW MANDRELS

For those desiring to make their own wood work, we can furnish Mandrels with balance wheel, pulleys and boxes. These are always made right-hand and furnished with yoked boxes, as shown above, unless otherwise ordered. If desired, they can be furnished with flat boxes without the yoke. Can also be furnished without balance wheel. Pulley is 6-inch diameter by 6-inch face. Weight of Mandrel, with boxes, pulley and balance wheel, 160 pounds. Boxed for export, 210 pounds, 4 cubic feet.
 Price.....\$22.00

FARM WAGONS

The Value of These New Weber Features Can Be Counted in Dollars and Cents. The Difference Is So Great That You Cannot Afford to Buy Any Other Wagon.

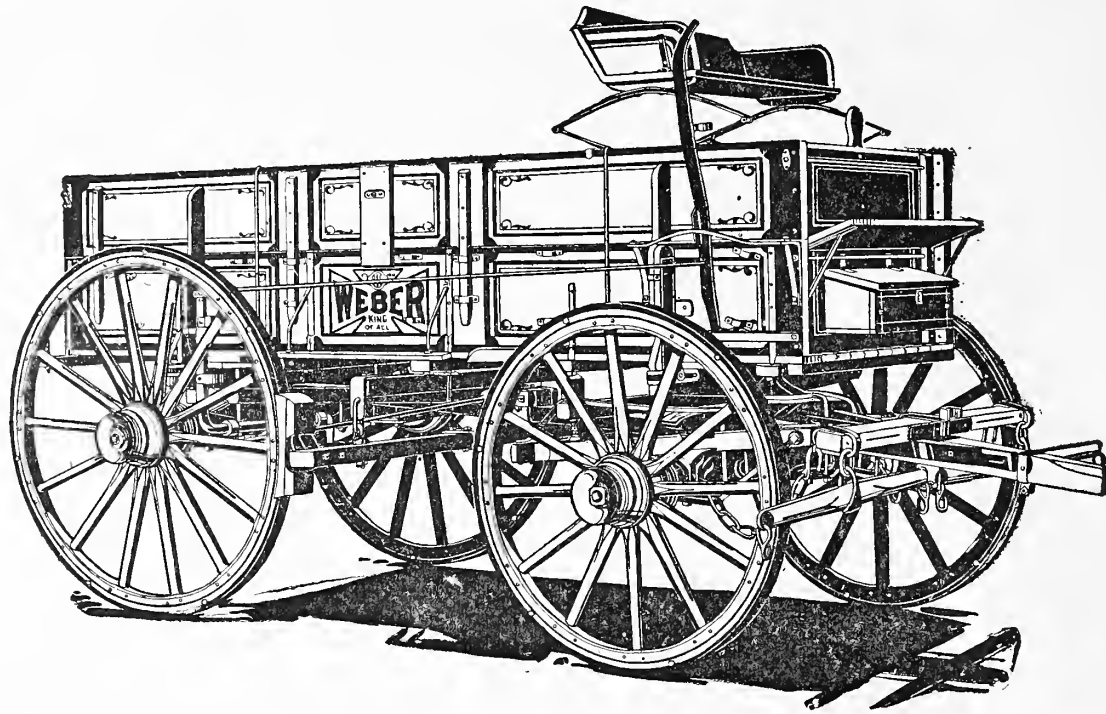

You don't have to guess how much of a load a Weber Auto-Track Wagon will carry. Its capacity is stamped right on the bolster—and every Weber is guaranteed to carry its rated capacity. There is never a come-back on this guarantee because Weber wheels and gears are made of "A" grade material and are exceptionally well built. Both the front and rear gears are reinforced at every point of wear and strain by liberal ironing and bracing. And added to this there is the Weber fifth wheel, which keeps the bolster from rocking and does away with unsteady drawing of the front gear, thereby lightening the draft.

Let a standardized Auto-Track Weber carry capacity loads for you.

SPECIFICATIONS

No.	Size of Axles.		Size of Tire.	Width of Body.	Length of Body.	Carrying Capacity.	Shipping Weight.	Prices on Application.
	Solid Steel.	Steel Skein.						
302	1½	2¾ x 8	2 in. x ½ in.	3 ft. 6 in.	9½ ft.	2,500	700	}
303	1¾	3 x 9	3 in. x ½ in.	3 ft. 6 in.	10 ft.	3,500	900	
304	1¾	3¼ x 10	4 in. x ⅝ in.	3 ft. 8 in.	10½ ft.	4,500	1,000	
305	2	3½ x 11	4 in. x ¾ in.	3 ft. 8 in.	11 ft.	6,500	1,100	

OUR HANDY STEEL-WHEEL FARM TRUCKS

All wood parts hardwood and well painted. Note the grooved tire, which protects the spokes of the wheel, and they last much longer than flat-tire wheels. Made in two sizes—No. 22 with 3x9 skeins, capacity 3,000 pounds; No. 24 with 3¼x10 skeins, capacity 4,000 pounds. Both Nos. 22 and 24 Trucks have 28-inch front and 30-inch rear wheels, 4x⅝ tires. Weights—No. 22, 475 pounds; No. 24, 510 pounds.

Above Truck can be furnished with wood wheels. Price, \$50.00.

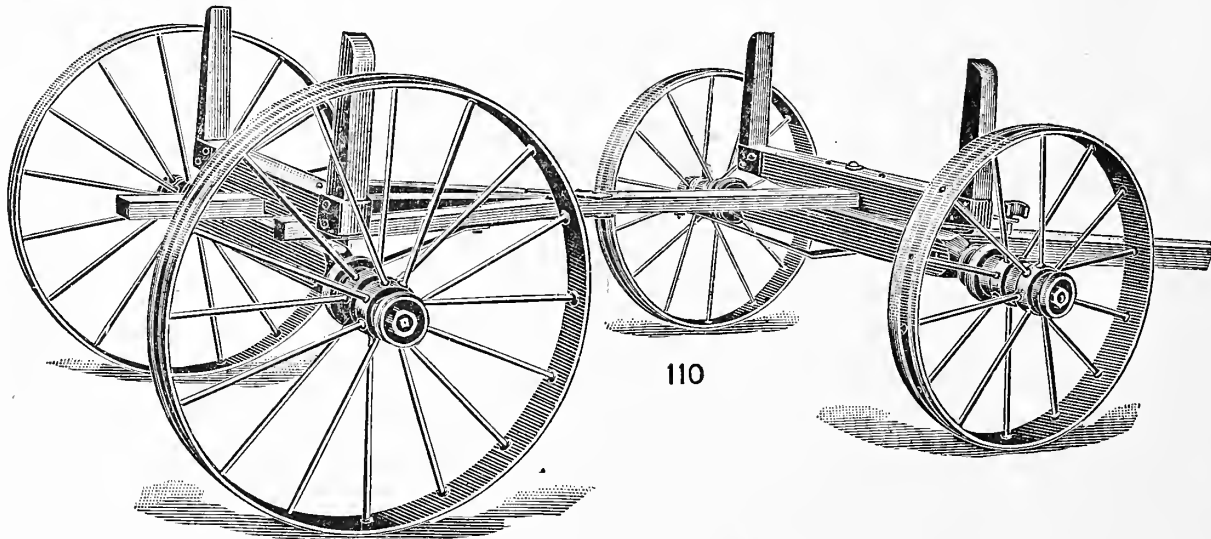

Wood Hounds, Well Braced; Hickory Axles.

FARM AND CONTRACT CARTS

Our Carts are built of hardwood, good dry stock. Bodies have 6-inch top sides. Wood hub wheels. The sizes we mention are those most popular with our trade, but we can furnish any size desired. The Carts are nicely finished and handsomely painted. They have but to be seen in comparison with others to be appreciated.

No. 38 FARM CART—1½-inch axle, 2x½-inch tire; body, 3 feet wide, 5 feet 1 inch long, 11 inches deep, without top sides; capacity, 1,000 pounds. Price on application.

No. 41 FARM OR LAWN CART—1¾-inch axle, 4x½-inch tire; body, 3 feet wide, 5 feet 4 inches long, 12 inches deep. Price on application.

No. 42 CONTRACT CART—2-inch axle, 3x½-inch tire; body, 3 feet 1 inch wide, 5 feet 10 inches long, 13 inches deep, without top sides; capacity, 2,000 pounds. Price on application.

Fill Your Wagon With "Wisdom" Tomatoes (See Page 23)

FEED GRINDERS

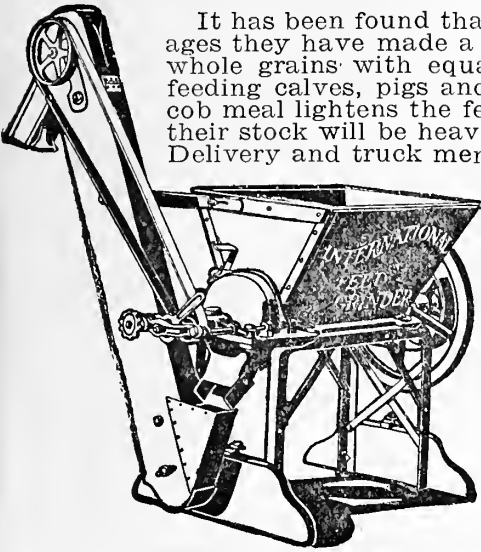

It has been found that when steers are fed on finely ground corn meal with other concentrates and roughages they have made a gain of nearly one-half pound more per day than those fed on the same amount of whole grains with equal amount of concentrates and roughages. Similar results have been secured in feeding calves, pigs and other live stock. Corn and cob meal is an excellent feed for dairy cows, as the cob meal lightens the feed and makes it more easily digested. Even the general farmers will find that their stock will be heavier and in a more healthy condition at a decreased cost if they grind their feed. Delivery and truck men whose horses are constantly on the go and have but a few minutes to eat while standing on the street will find that they can get more work from their teams if they feed them ground grain. The reason for the saving that results from such feeding is that the animals masticate ground grain more readily and it is more easily assimilated. The cost of feeding ground grain can be greatly reduced over what it costs when purchased from a custom grinder if an International Feed Grinder is used. One of the three types here described will be found adapted to every locality. The type B is intended for grinding corn on the cob and is supplied with a cob breaker and suitable grinding plates which pulverize both the corn and the cob thoroughly. The type C mill is designed for grinding small grain or shelled corn and is fitted with a feeding spiral which forces the grain to the grinding plates. The type D mill is intended for grinding corn in the husks and is supplied with revolving cutting knives which cut up the cobs and the husks so that the grinding plates can pulverize them. Various accessories for use with these mills are described in special catalogue.

Grinding feed means saving feed, and saving feed means saving money. You know from your own experience that when feeding whole corn or oats to your stock a large portion of it passes through the intestinal tract undigested. By experiment this has been found to be from 12 to 26 per cent. That means that 26 out of every 100 bushels of corn and 12 out of every 100 bushels of oats fed to farm animals is wasted. It fills the stomach and satisfies the hunger, but does not nourish them or increase their weight. The above figures are the results of experiments at government stations and the tests were made on animals with good teeth and otherwise in healthy condition. In cases where the animals' teeth are poor or they are afflicted with diseased mouth or gums, the loss is still greater, for in such cases they will swallow the grain whole.

It has been found in all experiments that a greater per cent of finely ground grain is assimilated than when it is simply cracked, for in the latter condition it is often swallowed whole. With the finely ground grain the stomach and intestinal juices can act upon it without the necessity of its being thoroughly masticated. The difficulty with which kaffir corn and milo maize are masticated because of their smallness and hardness makes them even less likely to be digested than Indian corn. Often one-third to one-half is swallowed whole. It is especially important then, if these grains are fed, to have them thoroughly ground. When fed to dairy cows, oats and corn ground together and fed with roughages have been found to produce from one to three pounds more milk per day with a corresponding increase in butter fat than when whole grain is fed with the same amount of roughages.

This plainly shows the economy of a feed grinder on the dairy farm, and points the way to larger returns for the man who is dissatisfied with his cream profits.

Prices of I. H. C. Feed Mills:

Type B, 6-inch.....	\$32.00	Type B, 10-inch.....	\$50.00
Type B, 8-inch.....	44.00.	Type D, 8-inch.....	50.00
Type D, 10-inch.....			\$55.00

NEW HOLLAND GRINDING MILLS FOR EAR CORN OR SHELLED GRAIN

These very popular and excellent working mills have a decided point in their favor, and that is that while doing excellent and fast work, they are slow-speed machines, a factor for reducing friction, and operate with less power than any other mill we know of. By a peculiar construction the ears are not crushed by main force as in other mills. The lugs of the cob grinders are placed spirally on the shaft, so that not more than 1 or 2 will catch the ears of corn at one time, and, being short, they pierce and break out pieces of the ear, and thus gradually reduce it. Having large pulleys and no extra shafts, belts, chain or cog gearing, the draft is made the lightest possible. Simplicity and durability are the keynotes in the construction of these mills. The frame is in one casting, and there is only one shaft; the cob grinders and grinding plates are all on this shaft. The material is of extra quality, and there are a number of little features about the mill which all go toward making it very durable and long-lived. The grinding plates are made of the hardest suitable metal.

No. 6½ NEW HOLLAND MILL

This mill may be operated with any light power, from 2 to 6 horsepower. The speed should be from 200 to 600 revolutions per minute, according to power. Light powers require lower speeds. Capacity, 6 to 30 bushels per hour. Price, complete, \$32.00.

No. 10 NEW HOLLAND MILL

Similar to the No. 6½, but is heavier, larger and has much greater capacity. It is suitable for any power, from 6 to 12 horse, and will grind from 20 to 60 bushels per hour. Speed required, 200 to 600 revolutions per minute.

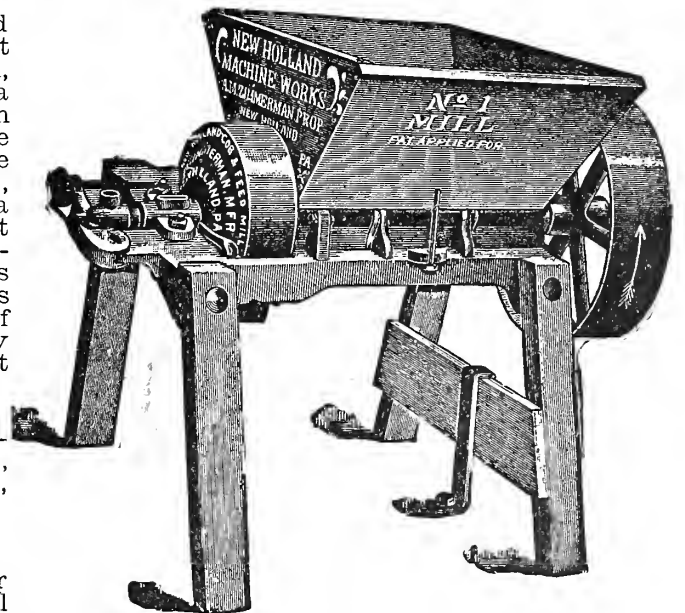

Price, complete, \$40.00.

ADVANTAGES IN CORN AND COB MEAL

The man with a good grinder has another decided advantage besides that of being able to feed ground grain instead of whole grain. He can increase the bulk of the corn he feeds from one-fifth to one-fourth by grinding cobs and corn together, making corn and cob meal. Hence he has more feed per acre of corn, and a feed upon which the stock will thrive better than on corn meal alone. Practical experiences of feeders all over the country and tests at Experiment Stations prove that better gains are made and less digestive troubles experienced when animals get corn and cob meal than when they get the corn meal only.

Corn meal is so heavy and condensed that when fed alone it lies in the digestive tract in too solid a mass for the digestive juices to thoroughly permeate it. Grinding the cob with the corn lightens the meal, makes it porous, prevents compaction in the stomach and alimentary canal and allows the digestive juices to go freely through the entire quantity.

Not only does the cob meal, when ground and fed with the corn meal, give valuable assistance to the process of digestion, but it contributes largely to the nutritive value of the feed as shown by analysis made at various State Experiment Colleges. General testimony seems to show that a pound of corn and cob meal has the same feeding value as a pound of pure corn meal.

INTERNATIONAL 8-16-H. P. TRACTOR

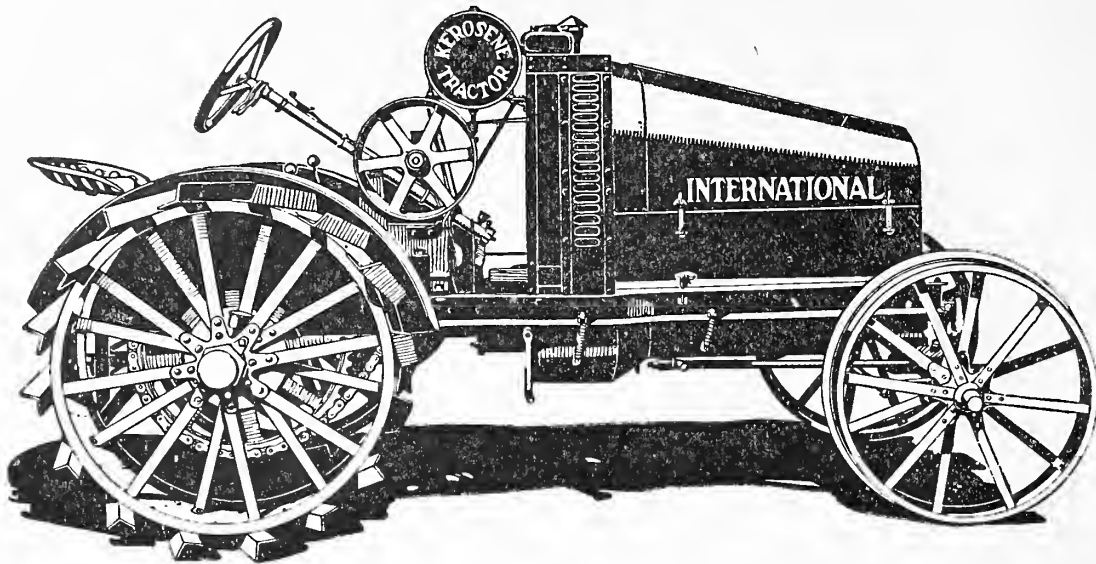

The International 8-16 Kerosene Tractor has 88 years of farm machine building experience and more than 13 years of tractor building knowledge back of it. It has passed successfully through long and rigid tests under actual field conditions in all sections of the country. It is a popular size and weight, and owners of the International 8-16 are pleased with the way it performs both on the drawbar and on the belt. It is because of the splendid way it performs under actual service day after day, year in and year out, that it is permitted to bear the name International. Knowing International Harvester tractors as no doubt you do, you can feel confident that you can get real service from this latest addition to the line. It is built to give additional credit to the already splendid reputation of I. H. C. tractors.

AUTO TYPE CENTRAL CONTROL

You will like the auto type centralized control used on the International 8-16 Kerosene Tractor. At your first opportunity, sit on the seat and note how convenient the levers and control are arranged. You will like the spring seat, which adds to the comfort of the operator. Observe the steering wheel is within easy reach of the operator's seat. The spark and throttle levers are as convenient as on an automobile. The speed changing levers are located on the left-hand side within easy reach. The clutch and brake are operated by foot pedals.

The transmission gearing is completely enclosed in a dust-proof case. All gears operate in a bath of oil. The gears are made of high-grade drop-forged steel. They are machined, carbonized and hardened. By carbonizing and hardening is meant the process that hardens the surface of the steel for wear, but still leaves the inside tough for strength. They are large, amply strong and would transmit a great deal more power than will ever be required of them. The high efficiency of the transmission is due to the use of roller bearings.

REPLACEABLE CYLINDER SLEEVES

The engine is built with removable, close-grained, gray iron cylinder sleeves. If the cylinder becomes scored, a new cylinder sleeve may be put in without having to discard the whole cylinder. This method of constructing the cylinders makes it possible to replace scored cylinders with the least possible cost.

I. H. C. Tractors made in three sizes—8x11; Titan, 10x20; 15x30.

INTERNATIONAL HAY PRESSES

Block Setter

The block-setting attachment on the 14x18 and 16x18-inch pull power presses consists of a sheet-steel block case bolted to the feeder side supports. To set the block with this device is a very easy matter. The block is laid upon the block case, and when the plunger comes forward the man who does the wiring pushes the block forward onto the block case.

Self-Feeder

The self-feeder used on the International Two-Horse and Motor Hay Presses increases the capacity of the press by securing regular feeding. The self-feeder works as regularly as the plunger operates, and if the hay is pitched into the hopper, it is sure to be forced into the bale chamber without delay. After using a press and becoming familiar with it, there is a tendency for the operator to become careless and try to get large charges of hay down into the bale chamber by using his feet. This is a very dangerous practice, and often results in serious injury to the operator. The use of the self-feeder eliminates all opportunity of resorting to this dangerous method of feeding.

The self-feeder is made almost entirely of steel, and is operated from the toggle links by means of heavy steel bars. This insures the feeder working as regularly as the plunger operates. A heavy relief spring affords sufficient resistance, and at the same time allows the feeder head to spring back if any hard foreign substance should get into the bale chamber. The feeder head lifts without pulling up any hay.

This feeder is not furnished for the One-Horse Press, and is only furnished for Two-Horse Presses when specially ordered at an additional cost. Regular on Motor Presses.

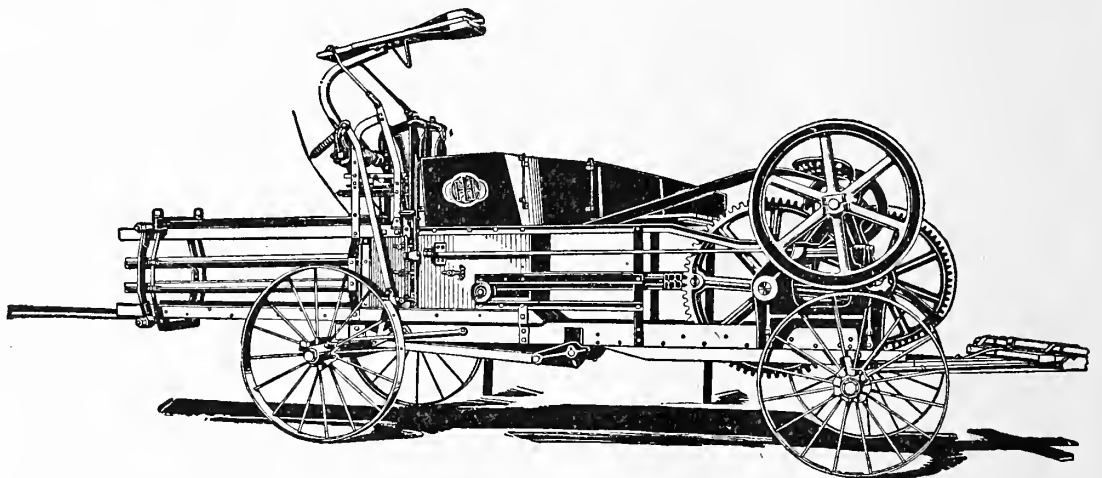

BALE FOR YOURSELF — BALE FOR YOUR NEIGHBORS

Make an Extra Profit

Baled hay brings higher market prices—allowing a profit on the baling.

The owner of a good hay press not only makes a profit on his own baling, but can do the work for others at a good profit.

When the hay is in the bale, the markets can be watched closely and shipments quickly made where prices are highest. Less storage space is required, and the bales are quickly and easily handled.

Save Room and Time

Save more room—baled hay occupies one-fifth the space that loose hay does. It is convenient to feed and transport. It insures the retention of a larger proportion of the nutrients of the baled hay or fodder.

Bale your oat straw and feed it with corn ensilage—it makes an excellent combination.

Own an International Hay Press, and whether you bale as a profession, side line or for your own farm use, you'll realize splendid profits.

Send For Special Catalogue and Prices

ROOFING, CEMENT AND PAINTS



Certain-teed Asphalt Roof Coating.

The life of composition roofing can be renewed and greatly prolonged by the use of this coating. A good roofing coated with Certain-teed every two or three years will last indefinitely. Price, 1 gal. \$1.00; 5 gals. \$3.75; 1/2 bbl. 60c per gal; bbls. 50c per gal.

Certain-teed Asbestos Roof Coating

Forms a durable weather-and-water proof surface for metal, concrete or other roofs. Also may be used on asphalt composition roofs and for general weather-proofing purposes, such as water-proofing foundations, etc. This is strictly an asphalt product. It contains no coal tar. Price: 1 gal. \$1.25; 5 gals. \$5.00; 1/2 bbl. 75c per gal.; bbls. 65c per gal.

Certain-teed Plastic Cement

A durable, permanent, weatherproof and waterproof composition of semi-hard consistency for repairing leaks in metal, shingle or composition roofs, for stopping holes in gutters, flashings, water troughs, etc., and for general weather-proofing purposes. Made of the best materials obtainable. Price:

1 lb. package.....	\$0.15	50 lb. package.....	\$4.50
10 lb. package.....	1.20	1/2 bbl., 275 lbs., per lb.....	.07
25 lb. package.....	2.50	Bbls., 450 lbs., per lb.....	.06

THE GUARD ROOFING

The Guard roofing is a very good grade of roofing, but, of course, cannot be compared with the Certain-Teed for durability. However, where a temporary roofing is desired it is just the thing. If weather conditions are not too severe it will last four or five years. It is fire-resisting, pliable and easy to put on in either cold or warm weather. The materials used in the manufacture of Guard Roofing has been selected with the best of care. Put up in rolls 36 inches wide, containing 108 square feet. Nails and cement packed on inside.

Prices:

1-ply.....	\$1.75
2-ply.....	2.25
3-ply.....	2.75

CERTAIN-TEED ROOFING

When you want a smooth-surfaced roofing for your house, barn, garage, factory, warehouse, skyscraper, church, apartment building or farm building, get **CERTAIN-TEED**—guaranteed 5, 10 or 15 years for 1, 2 or 3-ply, respectively—backed by the responsibility of the world's greatest and biggest roofing and building paper mills. The **Certain-teed** label on this roofing stand for a definite guaranteed service—a protection for you. Why try to save a dollar or two by putting on a cheap roof that is not guaranteed, when you can buy **Certain-teed** for just a little more money and get much longer service on your roof. In the long run it's less expensive to buy **Certain-teed**.

Prices:

1-ply, 108 square feet.....	\$2.25
2-ply, 108 square feet.....	2.75
3-ply, 108 square feet.....	3.25

PAINTS AND VARNISHES

We carry a full line of Paints and Varnishes for the rural and suburban trade. We specialize on barn and house paints of best quality, and our prices are as low as a quality paint can be sold. Write for details and prices.



CANS

GARBAGE CANS

(Galvanized.)

No.	Capacity, Gallons.	Price.
425	4	\$2.50
435	6 1/2	3.00
445	9 3/4	3.40

MONITOR ASH CANS

(Made of Heavy Galvanized Tin.)

No.	Capacity, Gallons.	Price.
2 1/2	11 3/4	\$4.00
3	17	4.75
4	22	5.00
5	24 3/4	5.75

Covers are not included in price.
Covers for Cans—2 1/2, 70c; 1.25.

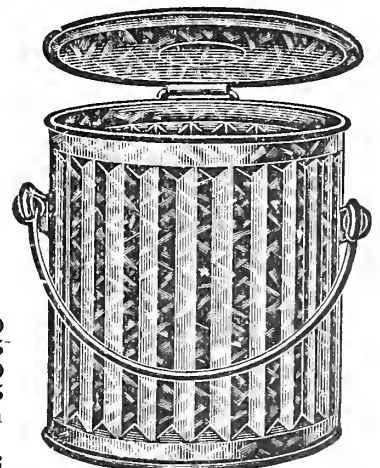
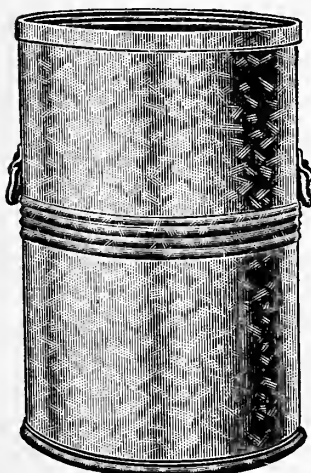

OIL AND GREASES

POLARINE



A perfect motor lubricant. No other oil has had a greater share in establishing the success and pleasure of motoring than Polarine.

Polarine is a scientifically prepared oil, designed to meet every need of the motorist, and may be relied upon to lubricate properly in either zero or tropical weather. Its adoption will add many years to the life of a car, in addition to securing freedom from carbon deposits in valves, cylinders and spark plugs.

Polarine is all oil—all lubrication; therefore unexcelled in friction-reducing properties.

Put up in one and five-gallon lithographed cans; also in half-barrels and barrels.

1-gal. can.....	\$1.25
5-gal. can.....	5.00
½ barrel, per gal.....	.65
Barrels, per gal.....	.60

RUDDY HARVESTER OIL (Ruby in Color)

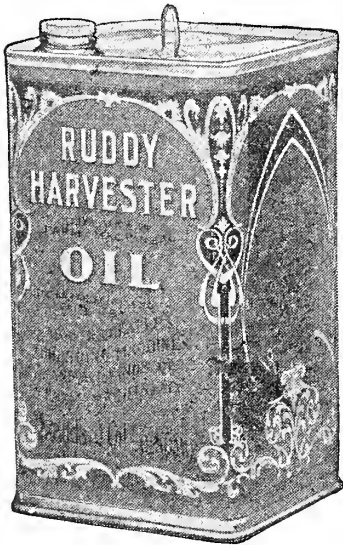

This oil is the result of many years of experience with the needs of the agricultural trade. It is especially adapted for use where a heavy oil is made necessary by loose bearings. It will stay where it is put; is not affected by extreme heat. It reduces friction to a minimum, and gives perfect lubrication.

Put up in quart, half-gallon, gallon and five-gallon lithographed cans; also in half-barrels and barrels.

½-gal. can.....	\$0.65
1-gal. can.....	1.00

HOUSEHOLD LUBRICANT

For use on lawn mowers, sewing machines, graphophones, hinges, etc. This is a very high-grade oil and is put up in very convenient four-ounce cans, ready for use. Price, 15c.

STANDARD HAND SEPARATOR OIL (Light Yellow in Color)



Standard Hand Separator Oil is a high-grade lubricant especially adapted for use on cream separators. It will not gum, rust or corrode the bearings.

It feeds freely into the closest bearings and insures the perfect lubrication that is essential to the free spinning of the bowl and the complete separation of cream from milk. It lessens the driving effort and lengthens the life of the separator.

Put up in quart, half-gallon, one-gallon and five-gallon lithographed cans; also in half-barrels and barrels.

1-qt. can.....	\$0.40
½-gal. can.....	.65
1-gal. can.....	1.00

1 Gallon

TRANSMISSION OIL

For use in transmission or gear cases, where a heavy bodied oil is required. It is a dark oil of highly efficient lubricating and long lasting qualities.

1-gallon cans.....	\$1.15
5-gallon cans.....	5.00

MICA AXLE GREASE



25-Pound Pail

Mica Axle Grease is the best that skill and science can produce. It is made of the best grease stock and ground mica, which fills up the pores and crevices in the axle and forms a hard, bright, smooth coating, thus reducing friction to the minimum. Mica Axle Grease never wears off, and it leaves no gum or paste on the spindles.

Mica Axle Grease is the most popular axle grease on the market, because it saves horsepower, saves harness repairs, saves wear and tear on wagons.

Mica Axle Grease can be supplied in one and three-pound lithographed tins, ten, fifteen and twenty-five-pound galvanized iron pails, fifty and 100-pound kegs and in half-barrels and barrels.

1-lb. box.....	\$0.15
15-lb. bucket.....	1.50
25-lb. bucket.....	2.50

EUREKA HARNESS OIL

(Very Dark Blue)

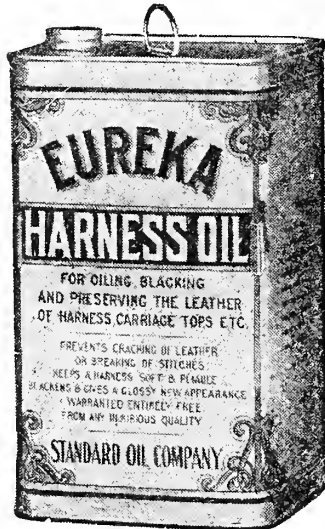

1 Gallon

Eureka Harness Oil is specially manufactured for oiling, blacking and preserving all kinds of leather, especially harness, automobile and carriage tops, etc.

All harness needs a preservative. To neglect it means that sooner or later it will crack and break.

In Eureka Harness Oil we offer the best harness oil obtainable. It is superior to all neatsfoot oils, because it is free from acids and will not become rancid. It penetrates the leather and prevents the cracking of leather and breaking of stitches; makes leather water-proof, and it lasts much longer and goes farther than any other oil

1-gal. can.....	\$1.25
-----------------	--------

THRESHER HARD OIL



5 Pounds

A lubricant adapted for general use on crank pins, shafting, loose pulleys, valve motions, eccentrics, slides, main journals, etc. For use in spring or compression cups or in open boxes.

Made in different consistencies, varying from No. 0, which is very soft, to No. 5, which is very hard, the intermediate grades being Nos. 1, 2, 3, 3½ and 4.

Put up in one, five, ten, twenty-five and fifty-pound lithographed tins; also in half-barrels and barrels.

1-lb. can.....	\$0.25
5-lb. can.....	1.00
10-lb. can.....	1.80
25-lb. can.....	4.50

COMPOUND NEAT'S-FOOT OIL

This is a combination of Neat's-Foot and Mineral oils in right proportions and properly compounded to prevent the Animal Oil from becoming rancid, thus producing a combination that will greatly improve Harness or any leather where this oil is used.

1-gallon cans.....	\$1.50
--------------------	--------

BUCKEYE "STANDARD" INCUBATORS

FOOLPROOF AND FIREPROOF

GUARANTEED To Hatch More Chicks and Stronger Chicks in the Hands of Any Beginner

So Simple They Can't Go Wrong—The Most Successful Hatching Device In The World

MADE IN FIVE SIZES—120 EGGS TO 600 EGGS



INCUBATORS

No. 14—Style E.....	\$ 16.50
No. 16—Style E.....	27.50
No. 17—Style E.....	36.75
No. 1—Standard.....	37.50
No. 2—Standard.....	44.50
No. 3—Standard.....	57.75
No. 4—Standard.....	68.00
No. 5—Standard.....	107.00

The case is made of California redwood and beautifully finished like a piece of fine furniture. It has perfectly insulated double top, and the walls are so constructed that the necessary temperature can easily be maintained in any location, even if it be freezing, or up to 100 degrees.

A Standard Buckeye Metal Thermostat regulates the temperature to a fraction of a degree. With this device it is only necessary to regulate the temperature when the hatch is started—then you forget it, because the regulator stays where you put it and the temperature of the egg chamber cannot change.

The tank is an improved design that absolutely insures a uniform temperature throughout the egg chamber. This means that the temperature of each and every egg will be exactly right, and if there's a chick in the egg,

you'll get it. The tank is equipped with an extra large boiler of new design, that insures the necessary heat, in any temperature, with an extremely small consumption of fuel. Both tank and boiler are made of a heavy, patented, rust-resisting metal that will last for years.

The complete lamp consists of a seamless, galvanized-steel bowl, a wide base "Miller" burner (the best burner made), and a one-piece galvanized-steel chimney. This lamp outfit is the best that money can buy—it's a lamp that won't smoke or get out of order. The lamp is self-adjusting, too! It sits on a portable support that always brings it to its correct position.

A Standard Buckeye Thermometer is included with each incubator, also a standard thermometer holder. With this equipment the correct temperature is always shown and the thermometer is always in its proper position. (Every Buckeye Standard Thermometer is guaranteed correct within one-fifth of one degree.)

The Improved Egg Tray is built to stay and will wear like iron.

A Standard Buckeye Egg Tester goes with every incubator. This enables the operator to follow the development of the chicks while they are hatching, also to remove the unfertile and unhatchable eggs.

The successful poultry breeder is the man or woman who has learned BY EXPERIENCE, and when you find hundreds of such breeders using a certain article year after year, you must be convinced that they have found that article to be ABSOLUTELY SATISFACTORY or they would not be using it. And when the article in question happens to be an incubator—the

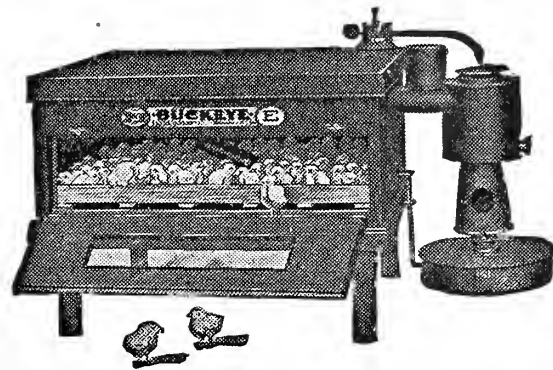

machine on which they must depend for the production of all the chickens they raise—it is a foregone conclusion that they could not be successful unless the incubators they are using are producing the highest percentage of

the highest grade chicks—the kind of chicks that enables them to perpetuate their stock and turn their product into profit.

THE STANDARD BROODER

Is Without Doubt the Most Successful Brooding Device Ever Invented



The Standard Brooder has actually revolutionized the whole poultry industry by helping the breeders to raise a much larger percentage of their youngstock with just about one-fourth of the labor.

For the big breeder it has been just as valuable through its ability to bring the young stock to quicker maturity and saving many valuable fowl that, under ordinary conditions, never would have survived.

Regardless of what they cost, there is no other brooder that compares with the Standard—that is the verdict of breeders who have tried them all.

Some brooders cost twice as much as the Standard because of their heavy complicated design,

but their additional weight and complicated appliances only make them less desirable.

It is the very simplicity of the Standard that makes it the best brooder on earth. With only a few simple parts the Standard accomplishes with never-failing certainty those things in which the more complicated devices fail.



BROODERS

No. 20—Metal Brooder.....	\$11.75
No. 21—Metal Brooder.....	15.50
No. 22—Metal Brooder.....	19.00
No. 18—Standard Brooder.....	21.50
No. 19—Standard Brooder.....	26.50
No. 25—Standard Brooder.....	30.00
No. 9—Blue Flame Brooder.....	9.75
No. 10—Blue Flame Brooder.....	17.50
No. 11—Blue Flame Brooder.....	20.00
No. 12—Blue Flame Brooder.....	22.50

We Deliver Free in the U.S. and possessions **by Parcel Post or Express** to Any Express Office **at Our Option**

**All Vegetable and Flower Seeds by the Packet, Ounce and 1/4 Pound
Lawn Grass Seeds by the Quart.**

Purchasers Pay Transportations on 1/2 Pounds, Pints, Quarts, 1/2 Pecks, Pecks, Bushels, and Barrels;
Also on Farm Seeds, Tools, Implements, Requisites, Fertilizers and Insecticides.

**If Wanted by Parcel Post, Add Postage as Noted for these
POSTAL WEIGHT OF BEANS, PEAS AND CORN, ONE POUND PER PINT.**

PARCEL POST RATES.

Weight in Pounds	Distance not over 150 miles	Over 150 and not over 300 miles	Over 300 and not over 600 miles	Over 600 and not over 1000 miles
1	\$.05	\$.06	\$.07	\$.08
2	.06	.08	.11	.14
3	.07	.10	.15	.20
4	.08	.12	.19	.26
5	.09	.14	.23	.32
6	.10	.16	.27	.38
7	.11	.18	.31	.44
8	.12	.20	.35	.50
9	.13	.22	.39	.56
10	.14	.24	.43	.62
11	.15	.26	.47	.68
12	.16	.28	.51	.74
13	.17	.30	.55	.80
14	.18	.32	.59	.86
15	.19	.34	.63	.92
16	.20	.36	.67	.98
17	.21	.38	.71	1.04
18	.22	.40	.75	1.10
19	.23	.42	.79	1.16
20	.24	.44	.83	1.22
21	.25	.46	.87	1.28
22	.26	.48	.91	1.34
23	.27	.50	.95	1.40
24	.28	.52	.99	1.46
25	.29	.54	1.03	1.52
26	.30	.56	1.07	1.58
27	.31	.58	1.11	1.64
28	.32	.60	1.15	1.70
29	.33	.62	1.19	1.76
30	.34	.64	1.23	1.82
31	.35	.66	1.27	1.88
32	.36	.68	1.31	1.94
33	.37	.70	1.35	2.00
34	.38	.72	1.39	2.06
35	.39	.74	1.43	2.12
36	.40	.76	1.47	2.18
37	.41	.78	1.51	2.24
38	.42	.80	1.55	2.30
39	.43	.82	1.59	2.36
40	.44	.84	1.63	2.42
41	.45	.86	1.67	2.48
42	.46	.88	1.71	2.54
43	.47	.90	1.75	2.60
44	.48	.92	1.79	2.66
45	.49	.94	1.83	2.72
46	.50	.96	1.87	2.78
47	.51	.98	1.91	2.84
48	.52	1.00	1.95	2.90
49	.53	1.02	1.99	2.96
50	.54	1.04	2.03	3.02
51	.55	1.06		
52	.56	1.08		
53	.57	1.10		
54	.58	1.12		
55	.59	1.14		
56	.60	1.16		
57	.61	1.18		
58	.62	1.20		
59	.63	1.22		
60	.64	1.24		
61	.65	1.26		
62	.66	1.28		
63	.67	1.30		
64	.68	1.32		
65	.69	1.34		
66	.70	1.36		
67	.71	1.38		
68	.72	1.40		
69	.73	1.42		
70	.74	1.44		

**INSECTICIDES
CANNOT
BE SENT BY
PARCEL
POST**

**WEIGHT OF AGRICULTURAL SEEDS,
PER BUSHEL, AND QUANTITY
USUALLY SOWN PER ACRE.**

Weight per Bushel.	Pounds per Acre.
14 lbs. Awnless Brome	35 to 40 lbs.
60 lbs. Alsike, alone	6 lbs.
60 lbs. Alfalfa or Lucerne	20 lbs.
48 lbs. Barley, broadcast	2 bus.
. lbs. Broom Corn, in hills	6 to 8 qts.
48 lbs. Buckwheat, broadcast	1 bus.
21 lbs. Crested Dog's Tail	25 lbs.
20 lbs. Creeping Bent	50 lbs.
60 lbs. Crimson Clover	15 to 20 lbs.
56 lbs. Corn, for soiling	1 to 2 bus.
24 lbs. English Rye or Perennial Rye	50 lbs.
20 lbs. Evergreen Lawn	3 to 4 bus.
56 lbs. Flax, for seed	1 bus.
. lbs. Flax, for fiber	2 to 3 bus.
56 lbs. Field Corn, in hills	4 qts.
50 lbs. German Millet	50 lbs.
48 lbs. Hungarian Millet	48 lbs.
44 lbs. Hemp	22 lbs.
20 lbs. Italian Rye	50 lbs.
14 lbs. Kentucky Blue	38 lbs.
22 lbs. Meadow Fescue	50 lbs.
7 lbs. Meadow Foxtail	30 lbs.
14 lbs. Orchard Grass	42 lbs.
32 lbs. Oats, broadcast	2 to 2 1/2 bus.
10 lbs. Red Top, chaff	40 to 50 lbs.
14 lbs. Red Top, unhulled	30 to 40 lbs.
32 lbs. Red Top, fancy	6 to 8 lbs.
60 lbs. Red Clover	15 lbs.
56 lbs. Rye, broadcast	1 bus.
12 lbs. Sheep Fescue	30 lbs.
48 lbs. Sorghum, drills	4 qts.
. lbs. Sorghum, broadcast	8 qts.
10 lbs. Tall Meadow Oat	50 lbs.
45 lbs. Timothy, alone	1/4 bus.
. lbs. Timothy, with other grasses	8 lbs.
Together for an acre	
. lbs. Red Clover	8 lbs.
. lbs. Timothy	10 lbs.
. lbs. Red Top	14 lbs.
. lbs. Teosinte, in hills	1 to 3 lbs.
60 lbs. Vetches, broadcast	1 bus.
14 lbs. Wood Meadow	30 lbs.
60 lbs. White Clover, alone	6 lbs.
. lbs. White Clover, with other grasses	3 lbs.
60 lbs. Wheat, broadcast	1 1/2 to 2 bus.
. lbs. Wheat, in drills	1 1/2 to 2 bus.

VEGETABLE SEED TABLE

**THE QUANTITY OF SEED USUALLY
SOWN TO AN ACRE.**

Asparagus	5 lbs.
Beans, dwarf in drills	1/2 to 3/4 bus.
Beans, pole, in hills	8 to 10 qts.
Beet, in drills	4 to 6 lbs.
Cabbage, in beds, to transplant	1/4 lb.
Carrot, in drills	2 to 3 lbs.
Celery, to transplant	1/2 lb.
Corn, in hills (sugar)	4 qts.
Kale	4 to 6 lbs.
Melon, musk	1 1/2 to 2 lbs.
Melon, water	2 to 3 lbs.
Mustard, broadcast	12 to 16 lbs.
Mangel wurzel	4 to 6 lbs.
Onions, in drills to make large onions	6 to 8 lbs.
Onion Seeds, for small sets	40 to 60 lbs.
Parsnips, in drills	4 to 6 lbs.
Peas, early, in drills	1 1/4 bus.
Peas, Marrowfat, in drills	1 1/4 bus.
Peas, broadcast	2 to 3 bus.
Potato, cut tubers in drills	8 to 11 bus.
Radish, in drills	6 to 8 lbs.
Radish, broadcast	10 lbs.
Salsify, in drills	6 to 8 lbs.
Spinach, in drills	12 to 20 lbs.
Squash, bush varieties, in hills	4 to 6 lbs.
Squash, running varieties, in hills	3 to 4 lbs.
Turnip, in drills	1 lb.
Turnip, broadcast	2 lbs.
Tomato, to transplant	1/4 lb.



FERTILIZERS



NITRATE OF SODA BLOOD, BONE AND TANKAGE
LAND PLASTER

SPECIAL STRAWBERRY TOP DRESSER

AGRICULTURAL HYDRATED LIME

PULVERIZED SHEEP MANURE

This is purely a natural and most nutritious plant food, clean to handle, and its effect is immediate and lasting. There is nothing better to mix with soil for potting plants. Florists who use it extensively advise mixing about one-seventh manure and six-sevenths soil. As a top dressing for lawns it is unequalled.

Prices—5 lbs. 25c. 10 lbs. 45c. 30 lbs. \$1.20. 50 lbs. \$1.75. 100 lbs. \$3.00.
Special prices in tons, half tons, or carload.

SOFT GROUND BONE

Made from softer material than the regular "Ground Bone," and contains some little meat and blood. The great objection to the use of Pure Bone (the price) no longer prevents its use by any one wanting to restore wornout land. Try it and be convinced.

Prices—5-lb. package 25c. 10-lb. package 45c. Per bag (200 lbs.) \$6.50. Per ton \$60.00.

DRIED BLOOD

For roses, carnations, etc. One of the quickest acting fertilizers, its chief element being nitrogen. Apply 300 lbs. per acre. For indoor culture it is unexcelled.

Prices—5 lbs. 60c. 10 lbs. \$1.00. 25 lbs. \$2.25. 50 lbs. \$4.00. 100 lbs. \$7.75. 200 lbs. \$15.00.

HEADQUARTERS FOR GARDEN AND SPRAY HOSE

WE CARRY IN
STOCK A FULL
LINE OF HOSE
FOR GARDEN
AND SPRAYING
PURPOSES

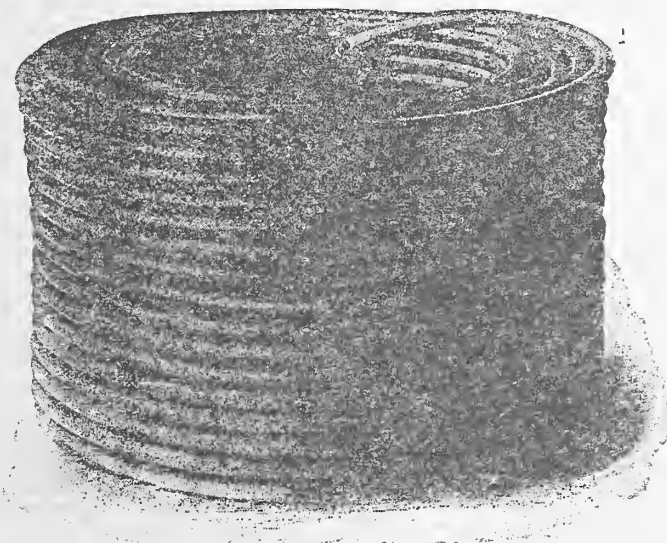

PRICES AND
SAMPLES
CHEERFULLY
SENT UPON
REQUEST



Full Line
of
Farm
Implements

Including

Planet Jr. Horse and Hand Garden Tools

Iron Age Horse and Hand Garden Tools

Bemis and Tiger Transplanters

All Sizes Gasoline and Kerosine Engines

Power and Spray Pumps

All Kinds of Spray Material and Insecticides